

FEATURES

- Low Power: $I_{CC} = 300\mu\text{A}$ Typ
- Designed for RS485 Interface Applications
- Single 5V supply
- -7V to 12V Bus Common Mode Range Permits $\pm 7\text{V}$ Ground Difference Between Devices on the Bus
- Thermal Shutdown Protection
- Power-Up/Down Glitch-Free Driver Outputs Permit Live Insertion or Removal of Transceiver
- Driver Maintains High Impedance in Three-State or with the Power Off
- Combined Impedance of a Driver Output and Receiver Allows Up to 32 Transceivers on the Bus
- 70mV Typical Input Hysteresis
- 30ns Typical Driver Propagation Delays with 5ns Skew
- Pin Compatible with $\pm 60\text{V}$ Protected LT1785 and 52Mbps LTC1685

APPLICATIONS

- Low Power RS485/RS422 Transceiver
- Level Translator

DESCRIPTION

The LTC[®]485 is a low power differential bus/line transceiver designed for multipoint data transmission standard RS485 applications with extended common mode range (12V to -7V). It also meets the requirements of RS422.

The CMOS design offers significant power savings over its bipolar counterpart without sacrificing ruggedness against overload of ESD damage.

The driver and receiver feature three-state outputs, with the driver outputs maintaining high impedance over the entire common mode range. Excessive power dissipation caused by bus contention or faults is prevented by a thermal shutdown circuit which forces the driver outputs into a high impedance state.

The receiver has a fail-safe feature which guarantees a high output state when the inputs are left open.

The LTC485 is fully specified over the commercial and extended industrial temperature range.

LT, LTC and LT are registered trademarks of Linear Technology Corporation.

TYPICAL APPLICATION

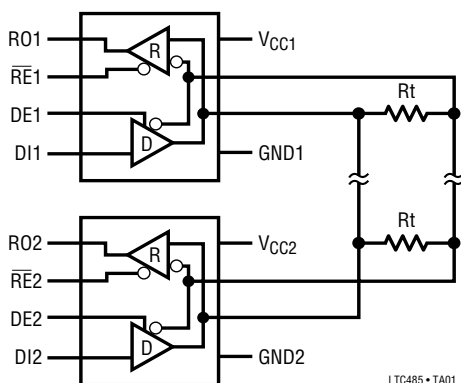

Driver Outputs

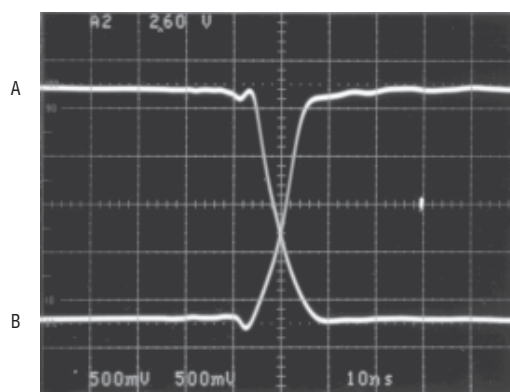

ABSOLUTE MAXIMUM RATINGS

(Note 1)

Supply Voltage	12V
Control Input Voltages	-0.5V to $V_{CC} + 0.5V$
Driver Input Voltage	-0.5V to $V_{CC} + 0.5V$
Driver Output Voltage	$\pm 14V$
Receiver Input Voltage	$\pm 14V$
Receiver Output Voltages	-0.5V to $V_{CC} + 0.5V$
Operating Temperature Range	
LTC485I	$-40^{\circ}C \leq T_A \leq 85^{\circ}C$
LTC485C	$0^{\circ}C \leq T_A \leq 70^{\circ}C$
LTC485M (OBSOLETE)	$-55^{\circ}C \leq T_A \leq 125^{\circ}C$
Lead Temperature (Soldering, 10 sec)	300°C

PACKAGE/ORDER INFORMATION

<p>TOP VIEW</p> <p>RO 1, RE 2, DE 3, DI 4, 8 V_{CC}, 7 B, 6 A, 5 GND</p> <p>N8 PACKAGE: 8-LEAD PLASTIC DIP S8 PACKAGE: 8-LEAD PLASTIC SOIC</p> <p>$T_{JMAX} = 125^{\circ}C, \theta_{JA} = 100^{\circ}C/W (N)$ $T_{JMAX} = 150^{\circ}C, \theta_{JA} = 150^{\circ}C/W (S)$</p> <p>J8 PACKAGE: 8-LEAD CERAMIC DIP $T_{JMAX} = 155^{\circ}C, \theta_{JA} = 100^{\circ}C/W (J)$</p> <p>OBSOLETE PACKAGE Consider the N8 Package for Alternate Source</p>	ORDER PART NUMBER
	LTC485CN8 LTC485CS8 LTC485IN8 LTC485IS8
	S8 PART MARKING
	485 485I
	ORDER PART NUMBER
	LTC485CJ8 LTC485MJ8

Consult LTC Marketing for parts specified with wider operating temperature ranges.

ELECTRICAL CHARACTERISTICS

The ● denotes the specifications which apply over the full operating temperature range, otherwise specifications are at $T_A = 25^{\circ}C$. $V_{CC} = 5V \pm 5\%$, unless otherwise noted. (Notes 2 and 3)

SYMBOL	PARAMETER	CONDITIONS	MIN	TYP	MAX	UNITS
V_{OD1}	Differential Driver Output Voltage (Unloaded)	$I_O = 0$	●		5	V
V_{OD2}	Differential Driver Output Voltage (with Load)	$R = 50\Omega$ (RS422) $R = 27\Omega$ (RS485), Figure 1	● ●	2 1.5	5	V V
ΔV_{OD}	Change in Magnitude of Driver Differential Output Voltage for Complementary States	$R = 27\Omega$ or $R = 50\Omega$, Figure 1	●		0.2	V
V_{OC}	Driver Common Mode Output Voltage	$R = 27\Omega$ or $R = 50\Omega$, Figure 1	●		3	V
$\Delta V_{OC} $	Change in Magnitude of Driver Common-Mode Output Voltage for Complementary States	$R = 27\Omega$ or $R = 50\Omega$, Figure 1	●		0.2	V
V_{IH}	Input High Voltage	DE, DI, \overline{RE}	●	2		V
V_{IL}	Input Low Voltage	DE, DI, \overline{RE}	●		0.8	V
I_{IN1}	Input Current	DE, DI, \overline{RE}	●		± 2	μA
I_{IN2}	Input Current (A, B)	DE = 0, $V_{CC} = 0V$ or 5.25V	● ●		± 1 -0.8	mA mA
V_{TH}	Differential Input Threshold Voltage for Receiver	$-7V \leq V_{CM} \leq 12V$	●	-0.2	0.2	V
ΔV_{TH}	Receiver Input Hysteresis	$V_{CM} = 0V$	●	70		mV
V_{OH}	Receiver Output High Voltage	$I_O = -4mA, V_{ID} = 200mV$	●	3.5		V
V_{OL}	Receiver Output Low Voltage	$I_O = 4mA, V_{ID} = -200mV$	●		0.4	V
I_{OZR}	Three-State (High Impedance) Output Current at Receiver	$V_{CC} = \text{Max}, 0.4V \leq V_O \leq 2.4V$	●		± 1	μA
R_{IN}	Receiver Input Resistance	$-7V \leq V_{CM} \leq 12V$	●	12		k Ω

SWITCHING CHARACTERISTICS

The ● denotes the specifications which apply over the full operating temperature range, otherwise specifications are at $T_A = 25^\circ\text{C}$, $V_{CC} = 5V \pm 5\%$, unless otherwise noted. (Notes 2 and 3)

SYMBOL	PARAMETER	CONDITIONS		MIN	TYP	MAX	UNITS
I_{CC}	Supply Current	No Load, Pins 2, 3, 4 = 0V or 5V	Outputs Enabled ●		500	900	μA
			Outputs Disabled ●		300	500	μA
I_{OSD1}	Driver Short-Circuit Current, $V_{OUT} = \text{HIGH}$	$V_O = -7V$	●	35	100	250	mA
I_{OSD2}	Driver Short-Circuit Current, $V_{OUT} = \text{LOW}$	$V_O = 10V$	●	35	100	250	mA
I_{OSR}	Receiver Short-Circuit Current	$0V \leq V_O \leq V_{CC}$	●	7		85	mA
t_{PLH}	Driver Input to Output	$R_{DIFF} = 54\Omega$, $C_{L1} = C_{L2} = 100\text{pF}$, (Figures 3 and 5)	●	10	30	50	ns
t_{PHL}	Driver Input to Output		●	10	30	50	ns
t_{SKEW}	Driver Output to Output		●		5	10	ns
t_r, t_f	Driver Rise or Fall Time		●	3	15	25	ns
t_{ZH}	Driver Enable to Output High	$C_L = 100\text{pF}$ (Figures 4 and 6) S2 Closed	●		40	70	ns
t_{ZL}	Driver Enable to Output Low	$C_L = 100\text{pF}$ (Figures 4 and 6) S1 Closed	●		40	70	ns
t_{LZ}	Driver Disable Time from Low	$C_L = 15\text{pF}$ (Figures 4 and 6) S1 Closed	●		40	70	ns
t_{HZ}	Driver Disable Time from High	$C_L = 15\text{pF}$ (Figures 4 and 6) S2 Closed	●		40	70	ns
t_{PLH}	Receiver Input to Output	$R_{DIFF} = 54\Omega$, $C_{L1} = C_{L2} = 100\text{pF}$, (Figures 3 and 7)	●	30	90	200	ns
t_{PHL}			●	30	90	200	ns
t_{SKD}	$ t_{PLH} - t_{PHL} $ Differential Receiver Skew		●		13		ns
t_{ZL}	Receiver Enable to Output Low	$C_{RL} = 15\text{pF}$ (Figures 2 and 8) S1 Closed	●		20	50	ns
t_{ZH}	Receiver Enable to Output High	$C_{RL} = 15\text{pF}$ (Figures 2 and 8) S2 Closed	●		20	50	ns
t_{LZ}	Receiver Disable from Low	$C_{RL} = 15\text{pF}$ (Figures 2 and 8) S1 Closed	●		20	50	ns
t_{HZ}	Receiver Disable from High	$C_{RL} = 15\text{pF}$ (Figures 2 and 8) S2 Closed	●		20	50	ns

Note 1: Absolute maximum ratings are those beyond which the safety of the device cannot be guaranteed.

Note 2: All currents into device pins are positive; all currents out of device pins are negative. All voltages are referenced to device ground unless otherwise specified.

Note 3: All typicals are given for $V_{CC} = 5V$ and $T_A = 25^\circ\text{C}$.

Note 4: The LTC485 is guaranteed by design to be functional over a supply voltage range of $5V \pm 10\%$. Data sheet parameters are guaranteed over the tested supply voltage range of $5V \pm 5\%$.

TYPICAL PERFORMANCE CHARACTERISTICS

Receiver Output Low Voltage vs Output Current

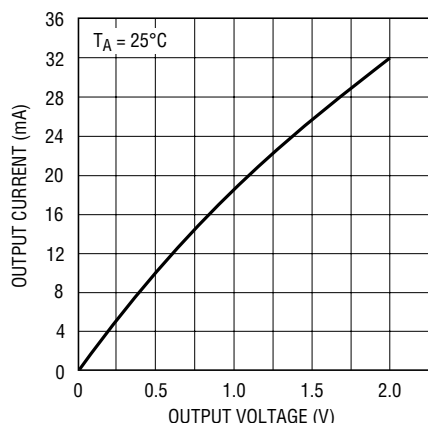

LTC485 • TPC01

Receiver Output High Voltage vs Output Current

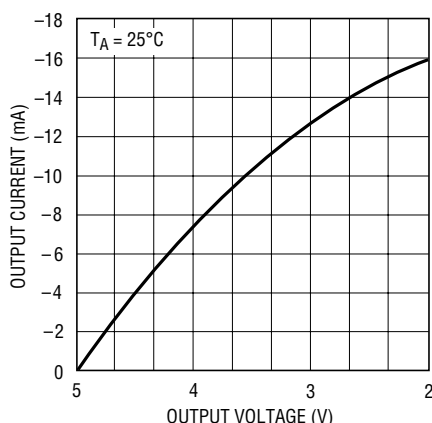

LTC485 • TPC02

Receiver Output High Voltage vs Temperature

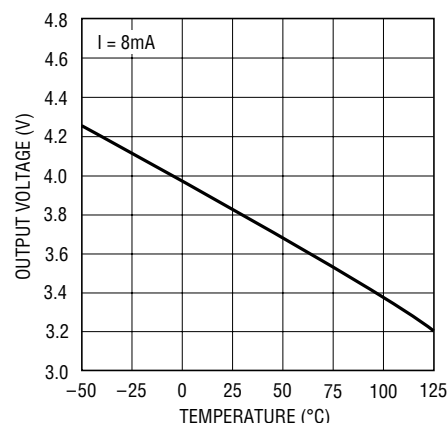

LTC485 • TPC03

sn 485LTC485ffs

TYPICAL PERFORMANCE CHARACTERISTICS

Receiver Output Low Voltage vs Temperature

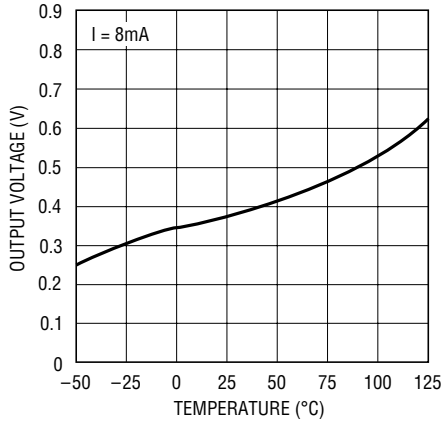

LTC485 • TPC03

Driver Differential Output Voltage vs Output Current

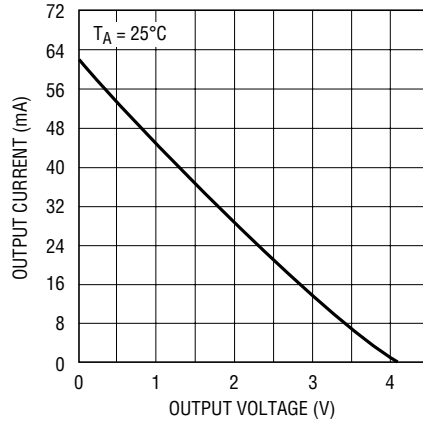

LTC485 • TPC05

Driver Differential Output Voltage vs Temperature

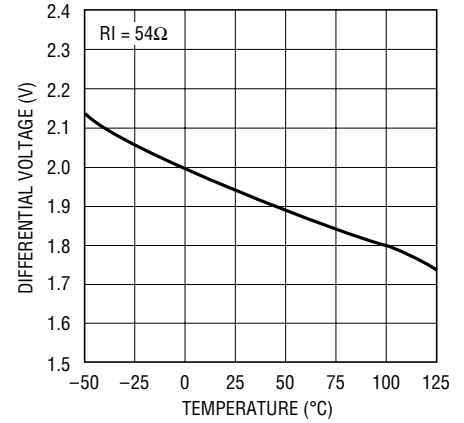

LTC485 • TPC06

Driver Output Low Voltage vs Output Current

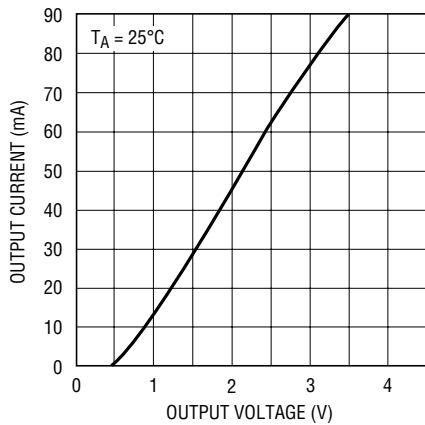

LTC485 • TPC07

Driver Output High Voltage vs Output Current

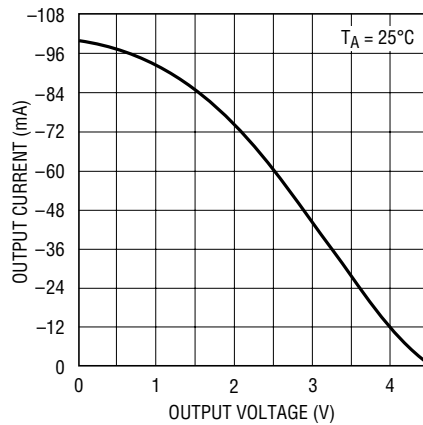

LTC485 • TPC08

TTL Input Threshold vs Temperature

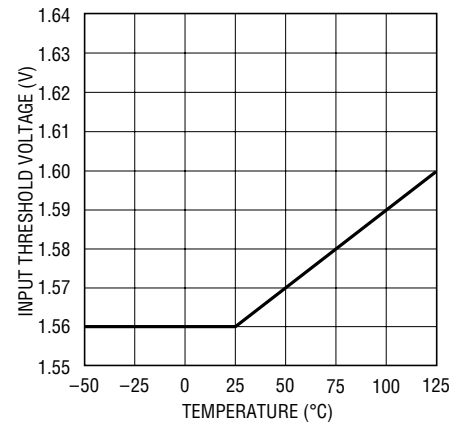

LTC485 • TPC09

Receiver |t_{PLH} - t_{PHL}| vs Temperature

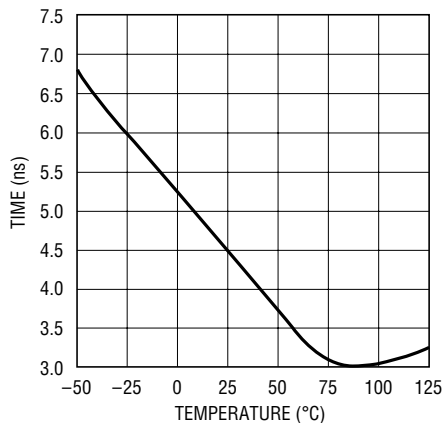

LTC485 • TPC10

Driver Skew vs Temperature

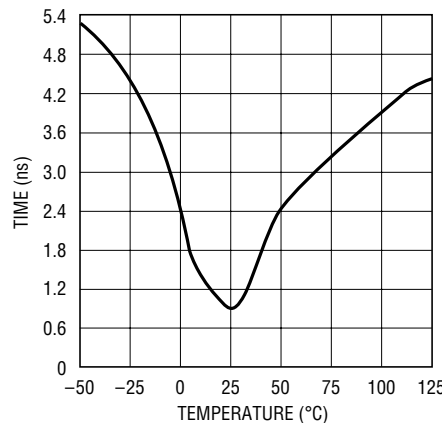

LTC485 • TPC11

Supply Current vs Temperature

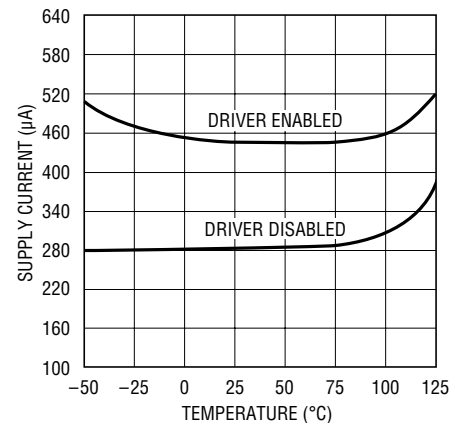

LTC485 • TPC12

PIN FUNCTIONS

RO (Pin 1): Receiver Output. If the receiver output is enabled (\overline{RE} low), then if $A > B$ by 200mV, RO will be high. If $A < B$ by 200mV, then RO will be low.

\overline{RE} (Pin 2): Receiver Output Enable. A low enables the receiver output, RO. A high input forces the receiver output into a high impedance state.

DE (Pin 3): Driver Outputs Enable. A high on DE enables the driver output. A and B, and the chip will function as a line driver. A low input will force the driver outputs into a high impedance state and the chip will function as a line receiver.

DI (Pin 4): Driver Input. If the driver outputs are enabled (DE high), then a low on DI forces the outputs A low and B high. A high on DI with the driver outputs enabled will force A high and B low.

GND (Pin 5): Ground Connection.

A (Pin 6): Driver Output/Receiver Input.

B (Pin 7): Driver Output/Receiver Input.

V_{CC} (Pin 8): Positive Supply; $4.75 < V_{CC} < 5.25$.

TEST CIRCUITS

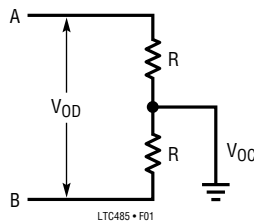

Figure 1. Driver DC Test Load

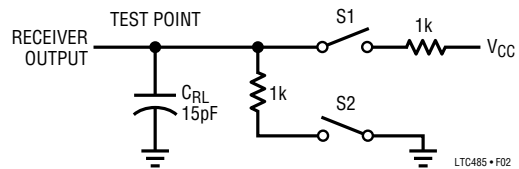

Figure 2. Receiver Timing Test Load

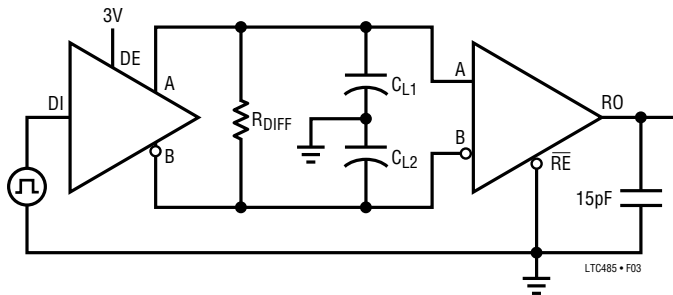

Figure 3. Driver/Receiver Timing Test Circuit

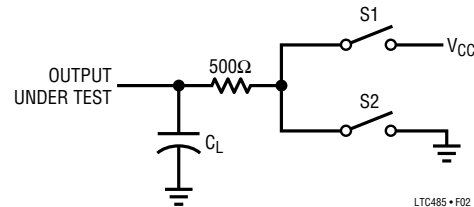

Figure 4. Driver Timing Test Load #2

SWITCHING TIME WAVEFORMS

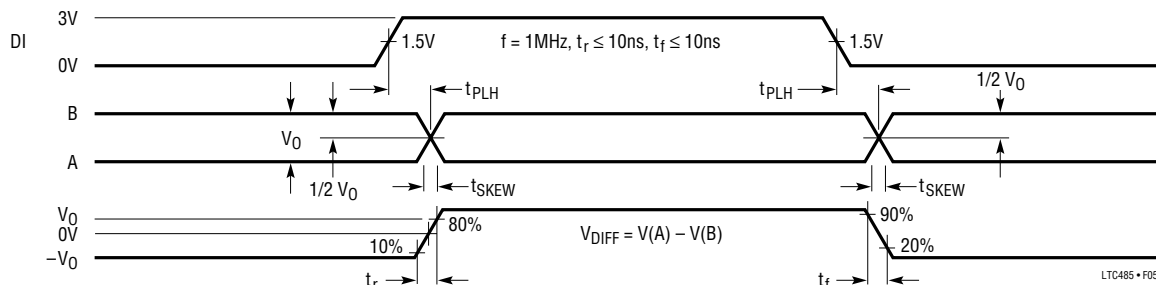

Figure 5. Driver Propagation Delays

SWITCHING TIME WAVEFORMS

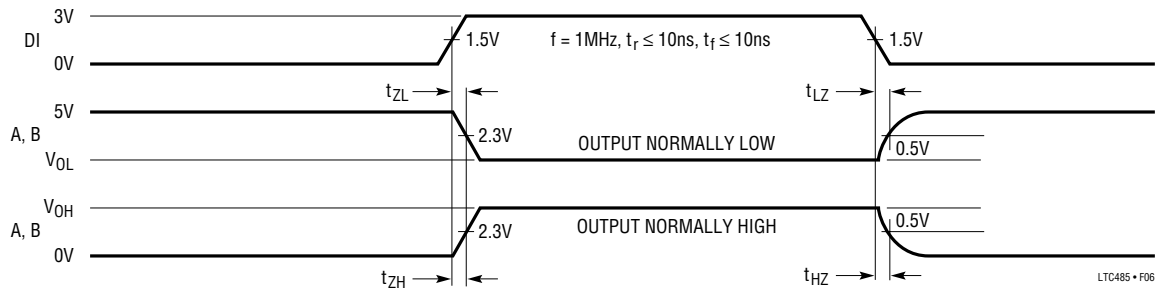

Figure 6. Driver Enable and Disable Times

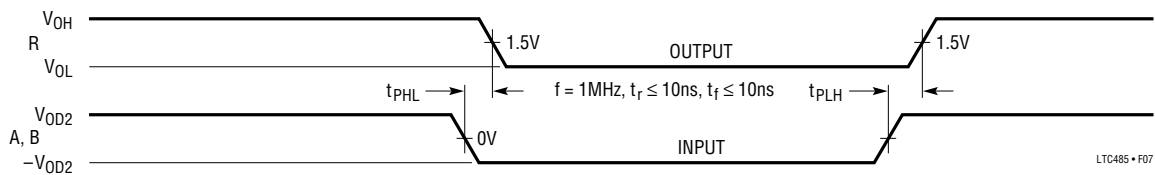

Figure 7. Receiver Propagation Delays

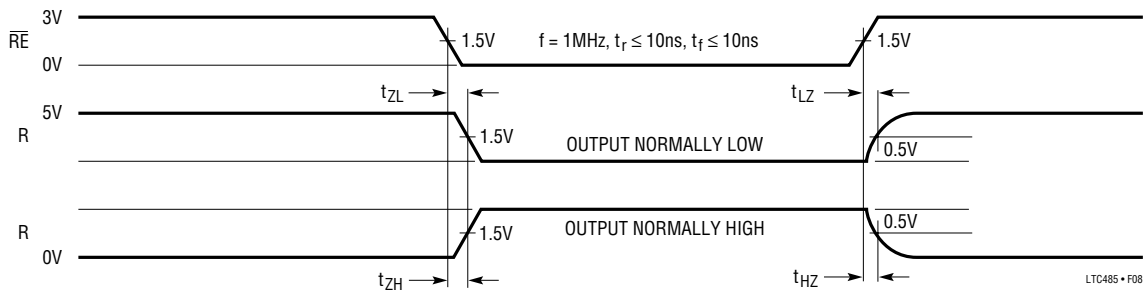

Figure 8. Receiver Enable and Disable Times

FUNCTION TABLES

LTC485 Transmitting

INPUTS			LINE CONDITION	OUTPUTS	
\overline{RE}	DE	DI		B	A
X	1	1	No Fault	0	1
X	1	0	No Fault	1	0
X	0	X	X	Z	Z
X	1	X	Fault	Z	Z

LTC485 Receiving

INPUTS			OUTPUTS
\overline{RE}	DE	A - B	R
0	0	$\geq 0.2V$	1
0	0	$\leq -0.2V$	0
0	0	Inputs Open	1
1	0	X	Z

sn485 LTC485ffs

APPLICATIONS INFORMATION

Basic Theory of Operation

Previous RS485 transceivers have been designed using bipolar technology because the common-mode range of the device must extend beyond the supplies and the device must be immune to ESD damage and latchup. Unfortunately, the bipolar devices draw a large amount of supply current, which is unacceptable for the numerous applications that require low power consumption. The LTC485 is the first CMOS RS485/RS422 transceiver which features ultra-low power consumption without sacrificing ESD and latchup immunity.

The LTC485 uses a proprietary driver output stage, which allows a common-mode range that extends beyond the power supplies while virtually eliminating latchup and providing excellent ESD protection. Figure 9 shows the LTC485 output stage while Figure 10 shows a conventional CMOS output stage.

When the conventional CMOS output stage of Figure 10 enters a high impedance state, both the P-channel (P1) and the N-channel (N1) are turned off. If the output is then driven above V_{CC} or below ground, the P + /N-well diode

(D1) or the N + /P-substrate diode (D2) respectively will turn on and clamp the output to the supply. Thus, the output stage is no longer in a high impedance state and is not able to meet the RS485 common-mode range requirement. In addition, the large amount of current flowing through either diode will induce the well known CMOS latchup condition, which could destroy the device.

The LTC485 output stage of Figure 9 eliminates these problems by adding two Schottky diodes, SD3 and SD4. The Schottky diodes are fabricated by a proprietary modification to the standard N-well CMOS process. When the output stage is operating normally, the Schottky diodes are forward biased and have a small voltage drop across them. When the output is in the high impedance state and is driven above V_{CC} or below ground, the parasitic diodes D1 or D2 still turn on, but SD3 or SD4 will reverse bias and prevent current from flowing into the N-well or the substrate. Thus, the high impedance state is maintained even with the output voltage beyond the supplies. With no minority carrier current flowing into the N-well or substrate, latchup is virtually eliminated under power-up or power-down conditions.

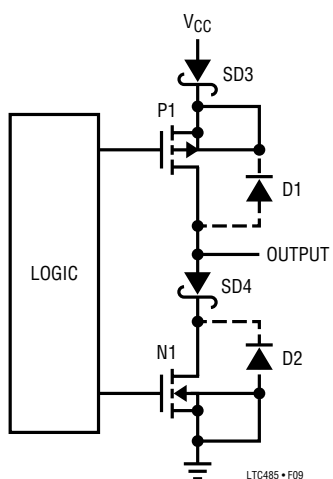

Figure 9. LTC485 Output Stage

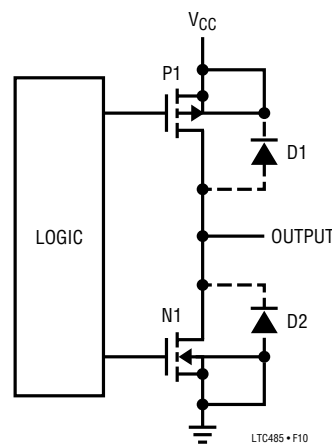

Figure 10. Conventional CMOS Output Stage

APPLICATIONS INFORMATION

The LTC485 output stage will maintain a high impedance state until the breakdown of the N-channel or P-channel is reached when going positive or negative respectively. The output will be clamped to either V_{CC} or ground by a Zener voltage plus a Schottky diode drop, but this voltage is way beyond the RS485 operating range. This clamp protects the MOS gates from ESD voltages well over 2000V. Because the ESD injected current in the N-well or substrate consists of majority carriers, latchup is prevented by careful layout techniques.

Propagation Delay

Many digital encoding schemes are dependent upon the difference in the propagation delay times of the driver and the receiver. Using the test circuit of Figure 13, Figures 11 and 12 show the typical LTC485 receiver propagation delay.

The receiver delay times are:

$$|t_{PLH} - t_{PHL}| = 9\text{ns Typ, } V_{CC} = 5\text{V}$$

The driver skew times are:

$$\text{Skew} = 5\text{ns Typ, } V_{CC} = 5\text{V}$$

$$10\text{ns Max, } V_{CC} = 5\text{V, } T_A = -40^\circ\text{C to } 85^\circ\text{C}$$

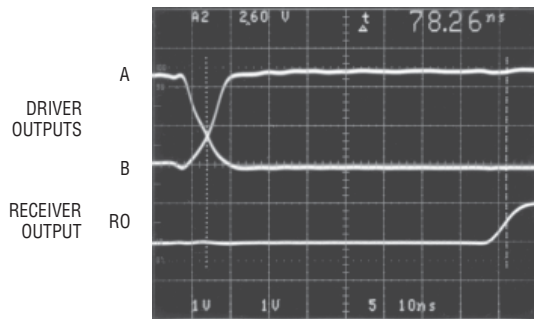

Figure 11. Receiver t_{PHL}

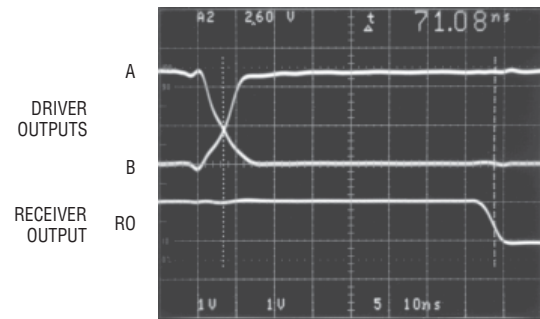

Figure 12. Receiver t_{PLH}

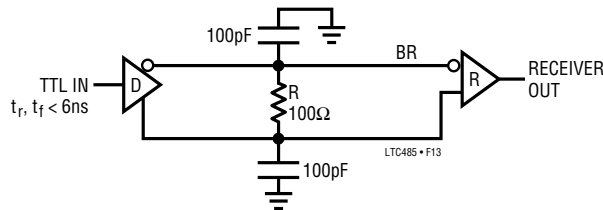

Figure 13. Receiver Propagation Delay Test Circuit

APPLICATIONS INFORMATION

LTC485 Line Length vs Data Rate

The maximum line length allowable for the RS422/RS485 standard is 4000 feet.

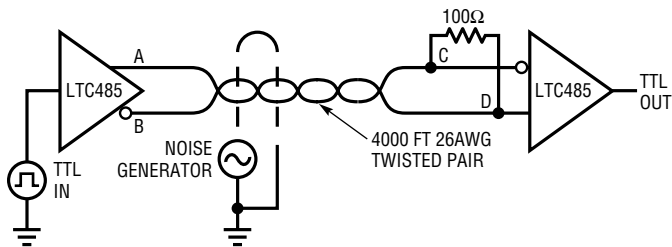

Figure 14. Line Length Test Circuit

Using the test circuit in Figure 14, Figures 15 and 16 show that with $\sim 20V_{P-P}$ common mode noise injected on the line, The LTC485 is able to reconstruct the data stream at the end of 4000 feet of twisted pair wire.

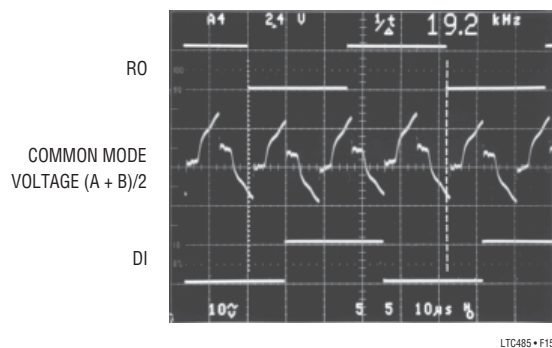

Figure 15. System Common Mode Voltage at 19.2kHz

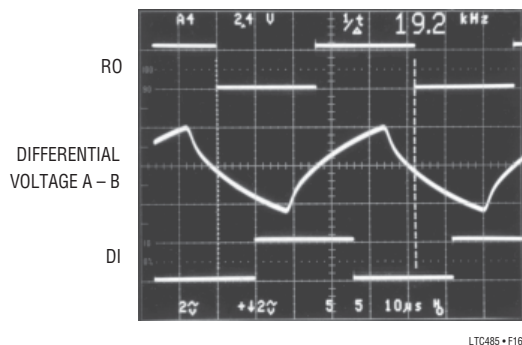

Figure 16. System Differential Voltage at 19.2kHz

Figures 17 and 18 show that the LTC485 is able to comfortably drive 4000 feet of wire at 110kHz.

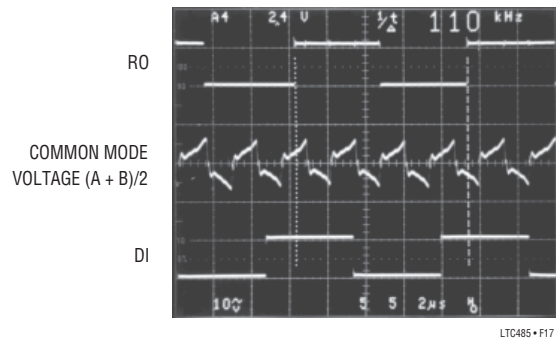

Figure 17. System Common Mode Voltage at 110kHz

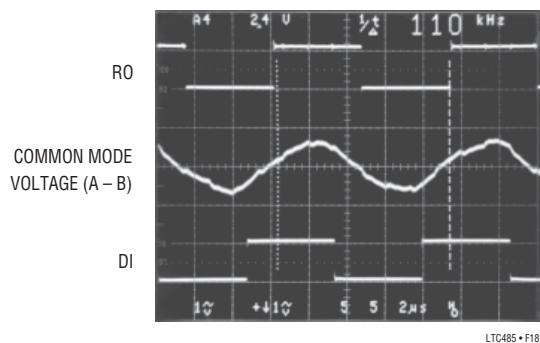

Figure 18. System Differential Voltage at 110kHz

When specifying line length vs maximum data rate the curve in Figure 19 should be used:

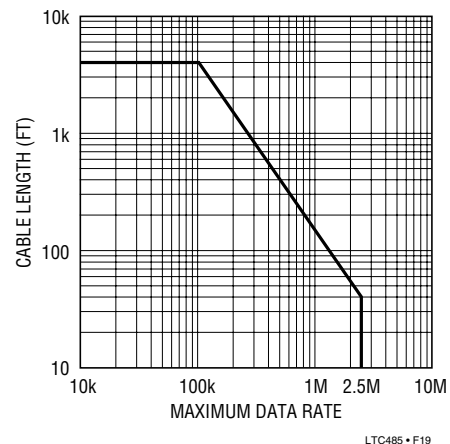
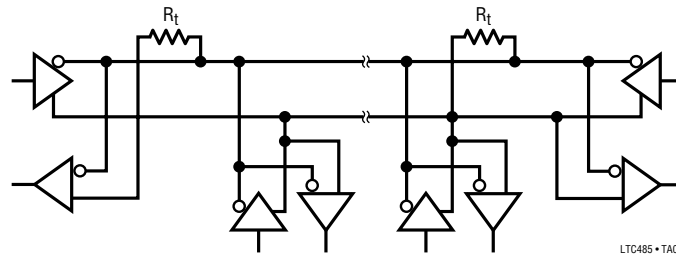

Figure 19. Cable Length vs Maximum Data Rate

TYPICAL APPLICATIONS

Typical RS485 Network



PACKAGE DESCRIPTION

J8 Package
8-Lead CERDIP (Narrow .300 Inch, Hermetic)
 (Reference LTC DWG # 05-08-1110)

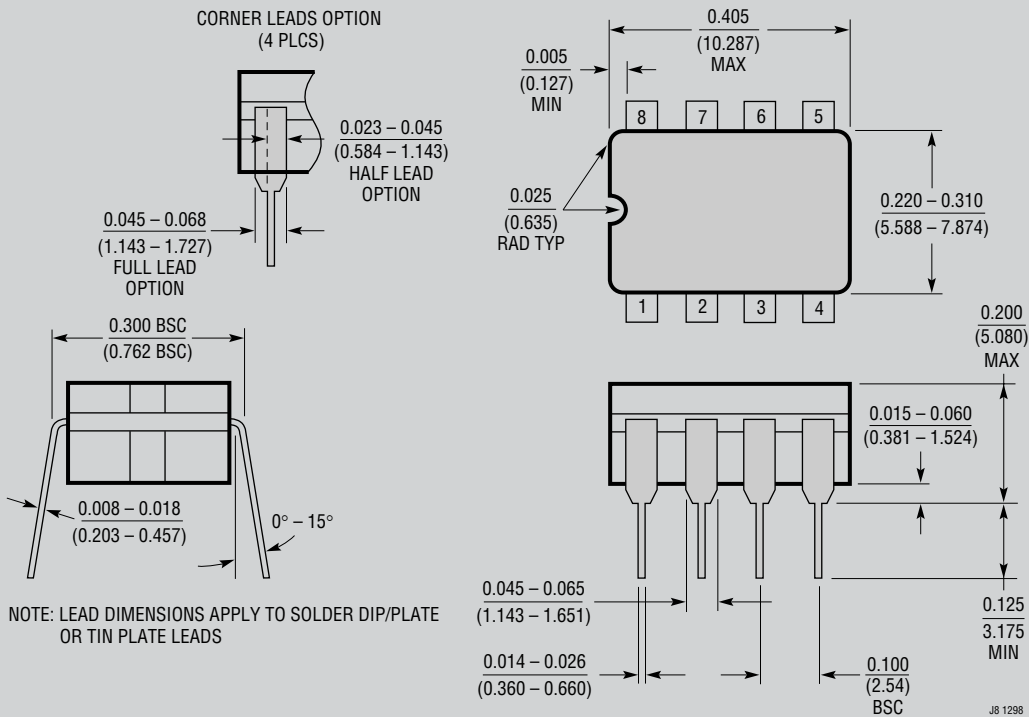

OBSOLETE PACKAGE

PACKAGE DESCRIPTION

N8 Package 8-Lead PDIP (Narrow .300 Inch) (Reference LTC DWG # 05-08-1510)

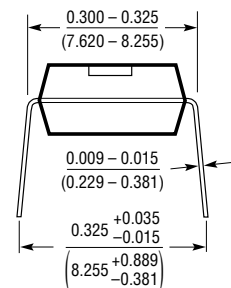
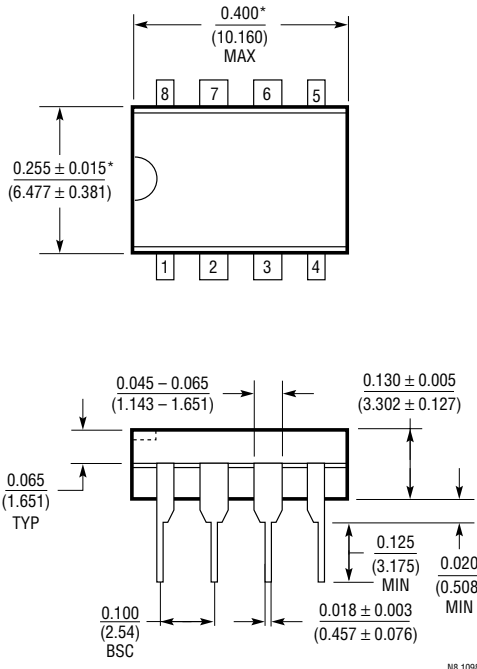

*THESE DIMENSIONS DO NOT INCLUDE MOLD FLASH OR PROTRUSIONS.
 MOLD FLASH OR PROTRUSIONS SHALL NOT EXCEED 0.010 INCH (0.254mm)

N8 1098

S8 Package 8-Lead Plastic Small Outline (Narrow .150 Inch) (Reference LTC DWG # 05-08-1610)

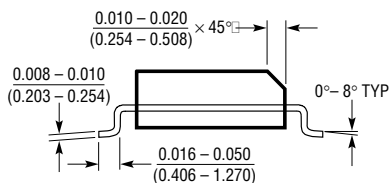
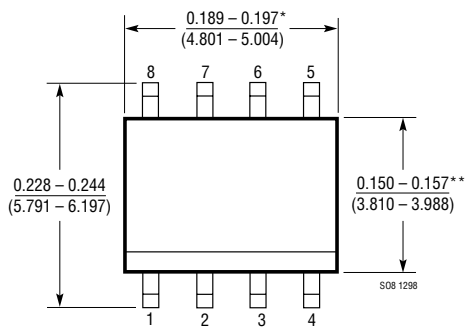

*DIMENSION DOES NOT INCLUDE MOLD FLASH. MOLD FLASH SHALL NOT EXCEED 0.006" (0.152mm) PER SIDE

**DIMENSION DOES NOT INCLUDE INTERLEAD FLASH. INTERLEAD FLASH SHALL NOT EXCEED 0.010" (0.254mm) PER SIDE

sn 485LTC485ffs

RELATED PARTS

PART NUMBER	DESCRIPTION	COMMENTS
LTC486/LTC487	Low Power Quad RS485 Drivers	110 μ A Supply Current
LTC488/LTC489	Low Power Quad RS485 Receivers	7mA Supply Current
LTC490/LTC491	Low Power Full-Duplex RS485 Transceivers	300 μ A Supply Current
LTC1480	3.3V Supply RS485 Transceiver	Lower Supply Voltage
LTC1481	Low Power RS485 Transceiver with Shutdown	Lowest Power
LTC1482	RS485 Transceiver with Carrier Detect	\pm 15kV ESD, Fail-Safe
LTC1483	Low Power, Low EMI RS485 Transceiver	Slew Rate Limited Driver Outputs, Lowest Power
LTC1484	RS485 Transceiver with Fail-Safe	\pm 15kV ESD, MSOP Package
LTC1485	10Mbps RS485 Transceiver	High Speed
LTC1518/LTC1519	52Mbps Quad RS485 Receivers	Higher Speed, LTC488/LTC489 Pin-Compatible
LTC1520	LVDS-Compatible Quad Receiver	100mV Threshold, Low Channel-to-Channel Skew
LTC1535	2500V Isolated RS485 Transceiver	Full-Duplex, Self-Powered Using External Transformer
LTC1685	52Mbps RS485 Transceiver	Industry-Standard Pinout, 500ps Propagation Delay Skew
LTC1686/LTC1687	52Mbps Full-Duplex RS485 Transceiver	LTC490/LTC491 Pin Compatible
LTC1688/LTC1689	100Mbps Quad RS485 Drivers	Highest Speed, LTC486/LTC487 Pin Compatible
LTC1690	Full-Duplex RS485 Transceiver with Fail-Safe	\pm 15kV ESD, LTC490 Pin Compatible
LT1785/LTC1785A	\pm 60V Protected RS485 Transceivers	\pm 15kV ESD, Fail-Safe (LT1785A)
LT1791/LTC1791A	\pm 60V Protected Full-Duplex RS485 Transceivers	\pm 15kV ESD, Fail-Safe (LT1791A)