

# International IR Rectifier HEXFRED™

PD -95686A

## HFA30PB120PbF

Ultrafast, Soft Recovery Diode

### Features

- Ultrafast Recovery
- Ultrasoft Recovery
- Very Low  $I_{RRM}$
- Very Low  $Q_{rr}$
- Guaranteed Avalanche
- Specified at Operating Conditions
- Lead-Free

### Benefits

- Reduced RFI and EMI
- Reduced Power Loss in Diode and Switching Transistor
- Higher Frequency Operation
- Reduced Snubbing
- Reduced Parts Count

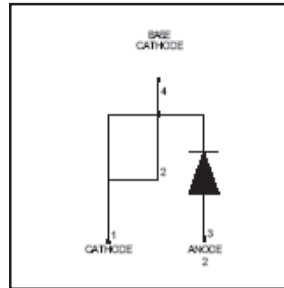

$V_R = 1200V$
$V_F(\text{typ.})^* = 2.3V$
$I_{F(AV)} = 30A$
$Q_{rr}(\text{typ.}) = 120nC$
$I_{RRM}(\text{typ.}) = 4.7A$
$t_{rr}(\text{typ.}) = 47ns$
$di_{(rec)M}/dt(\text{typ.})^* = 240A/\mu s$

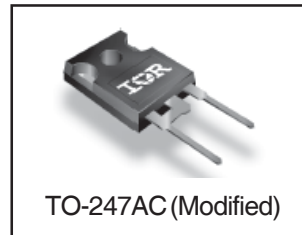

### Description

International Rectifier's HFA16PB120 is a state of the art center tap ultra fast recovery diode. Employing the latest in epitaxial construction and advanced processing techniques it features a superb combination of characteristics which result in performance which is unsurpassed by any rectifier previously available. With basic ratings of 1200 volts and 16 amps continuous current, the HFA16PB120 is especially well suited for use as the companion diode for IGBTs and MOSFETs. In addition to ultra fast recovery time, the HEXFRED product line features extremely low values of peak recovery current ( $I_{RRM}$ ) and does not exhibit any tendency to "snap-off" during the  $t_b$  portion of recovery. The HEXFRED features combine to offer designers a rectifier with lower noise and significantly lower switching losses in both the diode and the switching transistor. These HEXFRED advantages can help to significantly reduce snubbing, component count and heatsink sizes. The HEXFRED HFA16PB120 is ideally suited for applications in power supplies and power conversion systems (such as inverters), motor drives, and many other similar applications where high speed, high efficiency is needed.

### Absolute Maximum Ratings

	Parameter	Max.	Units
$V_R$	Cathode-to-Anode Voltage	1200	V
$I_F @ T_C = 100^\circ C$	Continuous Forward Current	30	A
$I_{FSM}$	Single Pulse Forward Current	120	
$I_{FRM}$	Maximum Repetitive Forward Current	90	
$P_D @ T_C = 25^\circ C$	Maximum Power Dissipation	350	W
$P_D @ T_C = 100^\circ C$	Maximum Power Dissipation	140	
$T_J$ $T_{STG}$	Operating Junction and Storage Temperature Range	-55 to + 150	$^\circ C$

\* 125°C

www.irf.com

1

11/2/04

# HFA30PB120PbF

International  
IRF Rectifier

## Electrical Characteristics @ $T_J = 25^\circ\text{C}$ (unless otherwise specified)

Symbol	Parameter	Min.	Typ.	Max.	Units	Conditions
$V_{BR}$	Cathode Anode Breakdown Voltage	1200	—	—	V	$I_R = 100\mu\text{A}$
$V_{FM}$	Max Forward Voltage	—	2.4	4.1	V	$I_F = 30\text{A}$ $I_F = 60\text{A}$ $I_F = 30\text{A}, T_J = 125^\circ\text{C}$
		—	3.1	5.7		
		—	2.3	4.0		
$I_{RM}$	Max Reverse Leakage Current	—	1.3	40	$\mu\text{A}$	$V_R = V_R$ Rated $T_J = 125^\circ\text{C}, V_R = 0.8 \times V_R$ Rated
		—	1.1	4000		
$C_T$	Junction Capacitance	—	50	75	pF	$V_R = 200\text{V}$ See Fig. 3
$L_S$	Series Inductance	—	8.0	—	nH	Measured lead to lead 5mm from package body

## Dynamic Recovery Characteristics @ $T_J = 25^\circ\text{C}$ (unless otherwise specified)

Symbol	Parameter	Min.	Typ.	Max.	Units	Conditions
$t_{rr}$	Reverse Recovery Time	—	47	—	ns	$I_F = 1.0\text{A}, di_F/dt = 200\text{A}/\mu\text{s}, V_R = 30\text{V}$ $T_J = 25^\circ\text{C}$ $T_J = 125^\circ\text{C}$
$t_{rr1}$	See Fig. 5, 10	—	110	170		
$t_{rr2}$		—	170	260		
$I_{RRM1}$	Peak Recovery Current	—	10	15	A	$T_J = 25^\circ\text{C}$ $T_J = 125^\circ\text{C}$
$I_{RRM2}$	See Fig. 6	—	16	24		
$Q_{rr1}$	Reverse Recovery Charge	—	650	980	nC	$T_J = 25^\circ\text{C}$ $T_J = 125^\circ\text{C}$
$Q_{rr2}$	See Fig. 7	—	1540	2310		
$di_{(rec)}/dt1$	Peak Rate of Fall of Recovery Current	—	270	—	A/ $\mu\text{s}$	$T_J = 25^\circ\text{C}$ $T_J = 125^\circ\text{C}$
$di_{(rec)}/dt1$	During $t_b$ See Fig. 8	—	240	—		

## Thermal - Mechanical Characteristics

	Parameter	Min.	Typ.	Max.	Units
$T_{lead}^{(2)}$	Lead Temperature	—	—	300	$^\circ\text{C}$
$R_{qJC}$	Thermal Resistance, Junction-to-Case	—	—	0.36	$^\circ\text{C}/\text{W}$
$R_{qJA}^{(3)}$	Thermal Resistance, Junction-to-Ambient	—	—	80	
$R_{qCS}^{(4)}$	Thermal Resistance, Case-to-Heat Sink	—	0.50	—	
$Wt$	Weight	—	2.0 (0.07)	—	g (oz.)
	Mounting Torque	6.0	—	12	kg-cm
		5.0	—	10	lbf-in

### Notes:

- ①  $L = 100\mu\text{H}$ , duty cycle limited by max  $T_J$
- ② 0.063 in. from Case (1.6mm) for 10 sec
- ③ Typical Socket Mount
- ④ Mounting Surface, Flat, Smooth and Greased

# HFA30PB120PbF

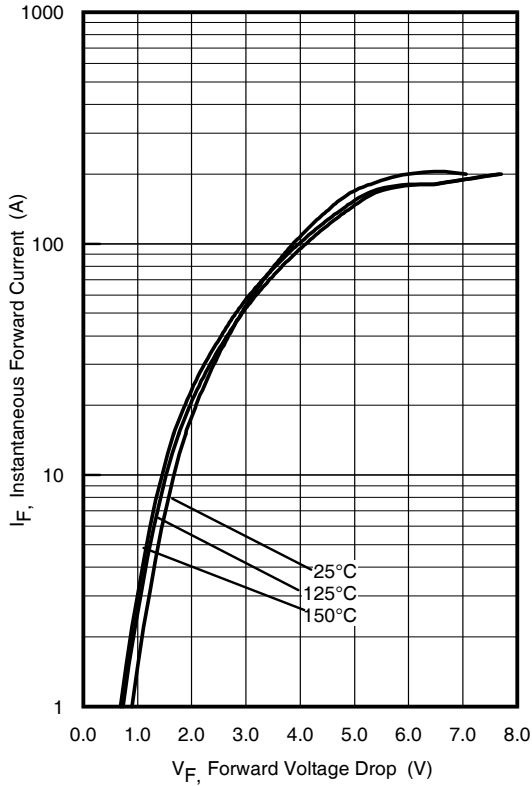

**Fig. 1 - Maximum Forward Voltage Drop vs. Instantaneous Forward Current**

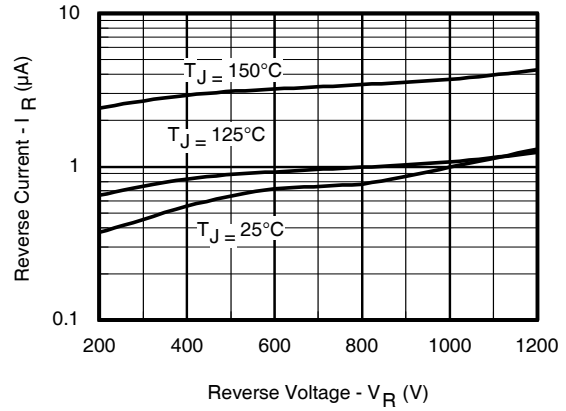

**Fig. 2 - Typical Reverse Current vs. Reverse Voltage**

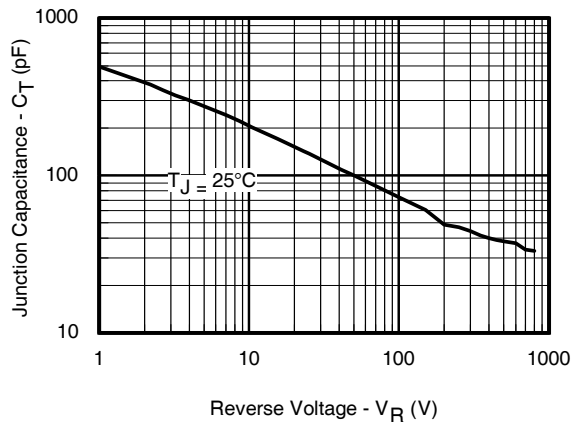

**Fig. 3 - Typical Junction Capacitance vs. Reverse Voltage**

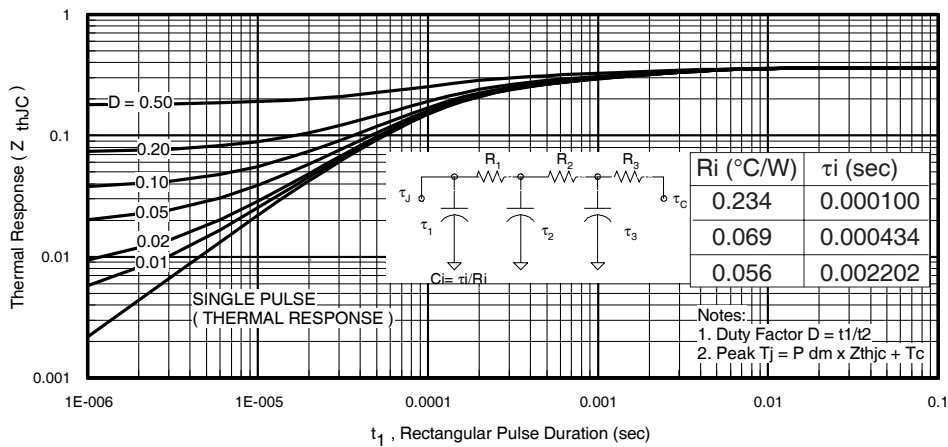

**Fig. 4 - Maximum Thermal Impedance  $Z_{thjc}$  Characteristics**

# HFA30PB120PbF

International  
**IR** Rectifier

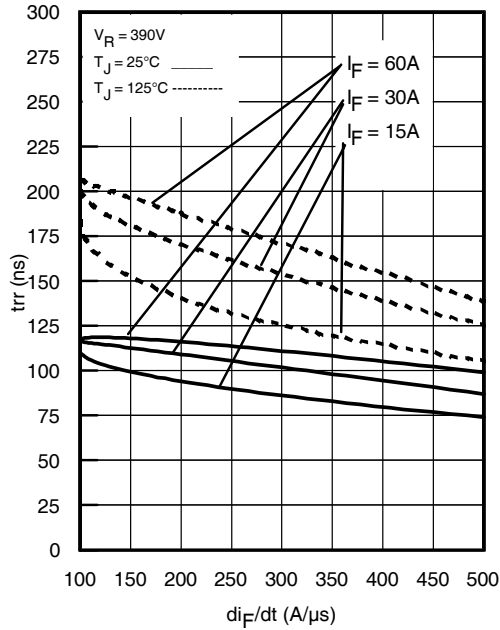

**Fig. 5** - Typical Reverse Recovery vs.  $di_f/dt$ , (per Leg)

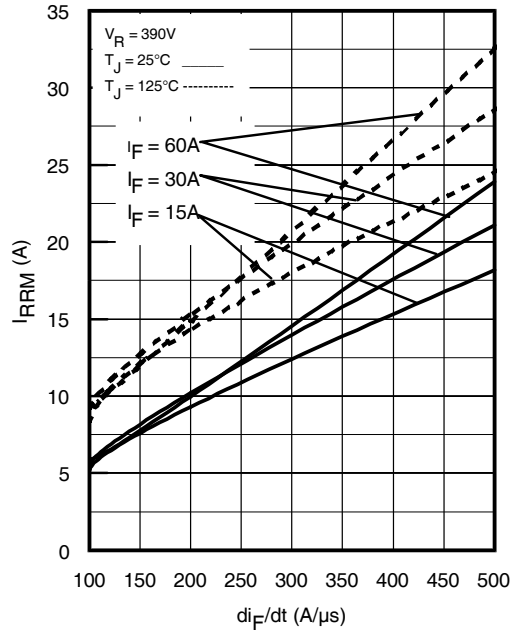

**Fig. 6** - Typical Recovery Current vs.  $di_f/dt$ , (per Leg)

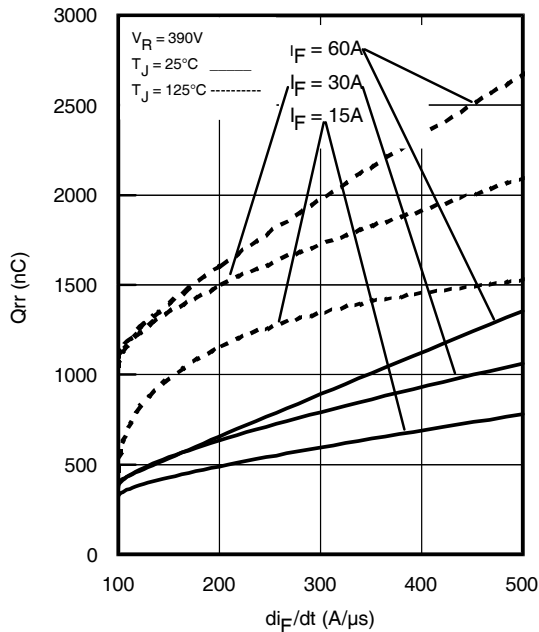

**Fig. 7** - Typical Stored Charge vs.  $di_f/dt$ , (per Leg)

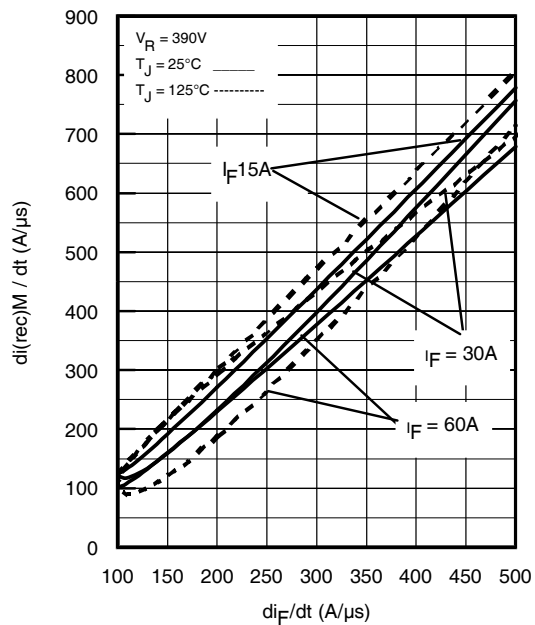

**Fig. 8** - Typical  $di_{(rec)M}/dt$  vs.  $di_f/dt$ , (per Leg)

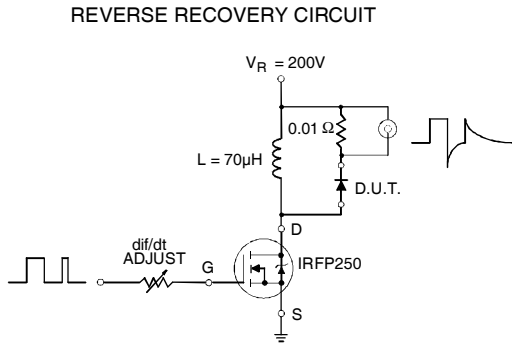

**Fig. 9 - Reverse Recovery Parameter Test Circuit**

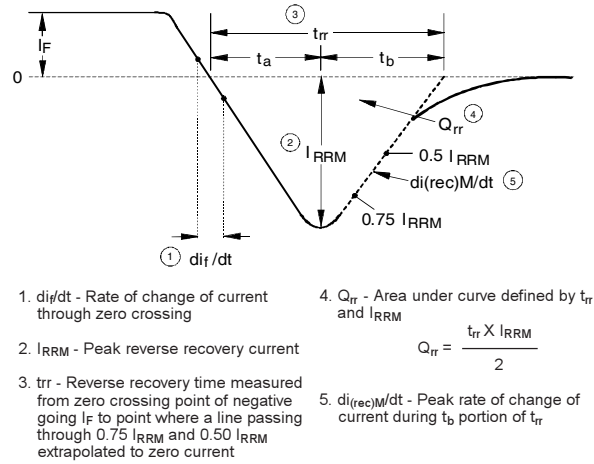

**Fig. 10 - Reverse Recovery Waveform and Definitions**

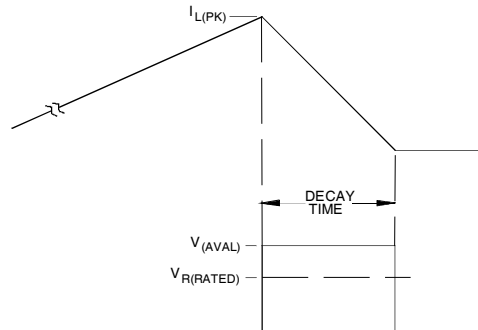
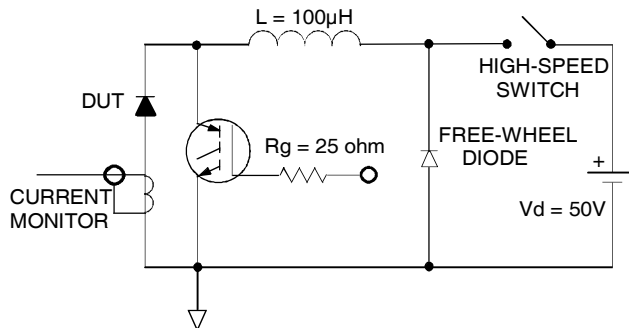

**Fig. 11 - Avalanche Test Circuit and Waveforms**

# HFA30PB120PbF

International  
**IR** Rectifier

## TO-247AC (Modified) Package Outline Drawing

Dimensions are in millimeters (inches)

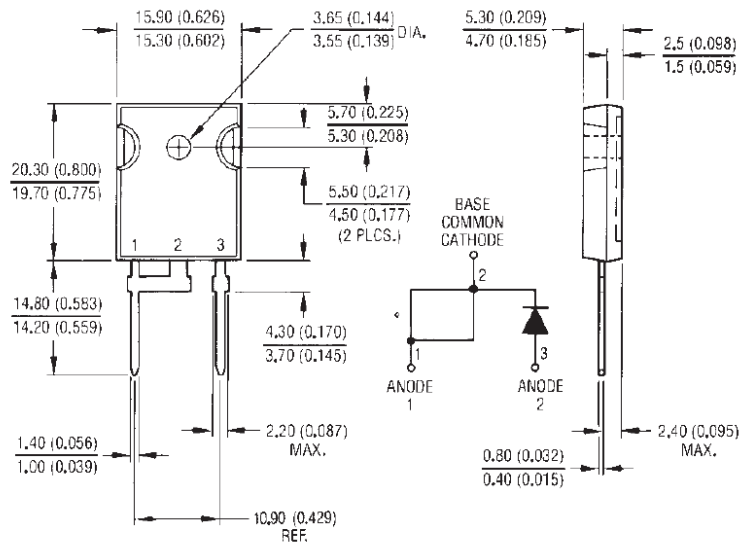

Conforms to JEDEC Outline TO-247AC(Modified)  
Dimensions in millimeters and inches

Note: Marking "P" indicates Lead-Free

Data and specifications subject to change without notice.

International  
**IR** Rectifier

IR WORLD HEADQUARTERS: 233 Kansas St., El Segundo, California 90245, USA Tel: (310) 252-7105  
TAC Fax: (310) 252-7903

Visit us at [www.irf.com](http://www.irf.com) for sales contact information.11/04

[www.irf.com](http://www.irf.com)