

N-Channel Enhancement Mode Power MOSFET

■ Features

- Low On-resistance
- Capable of 2.5V Gate Drive
- Optimal DC/DC battery application

■ General Description

The advanced power MOSFET provides the designer with the best combination of fast switching, ruggedized device design, ultra low on-resistance and cost-effectiveness.

■ Product Summary

BV _{DSS} (V)	r _{DS(on)} (mΩ)	I _D (A)
20	23	5

■ Pin Assignments

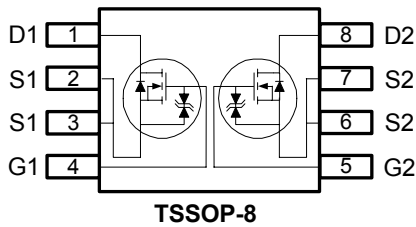

■ Pin Descriptions

Pin Name	Description
S1/2	Source
G1/2	Gate
D1/2	Drain

■ Ordering information

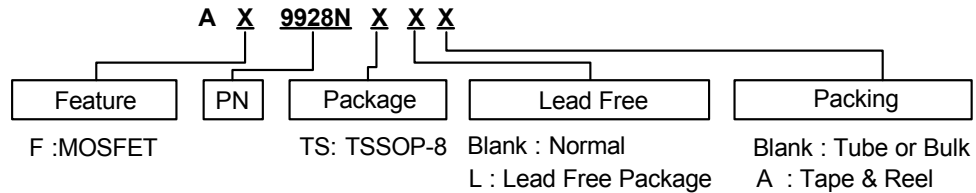



N-Channel Enhancement Mode Power MOSFET

■ Absolute Maximum Ratings

Symbol	Parameter	Rating	Units
V_{DS}	Drain-Source Voltage	20	V
V_{GS}	Gate-Source Voltage	± 12	V
I_D	Drain Current (Note 1), at $V_{GS}=4.5V$	at $T_A=25^\circ C$	5
		at $T_A=70^\circ C$	3.5
I_{DM}	Pulsed Drain Current (Note 2)	25	A
P_D	Total Power Dissipation	at $T_A=25^\circ C$	1
	Linear Derating Factor		0.008
T_{STG}	Storage Temperature Range	-55 to 150	$^\circ C$
T_J	Operating Junction Temperature Range	-55 to 150	$^\circ C$

■ Thermal Data

Symbol	Parameter	Value	Units
Rthj-a	Thermal Resistance Junction-Ambient (Note 1) Max.	125	$^\circ C/W$

Note 1: Surface mounted on 1 in² copper pad of FR4 board, 208 $^\circ C/W$ when mounted on Min. copper pad.

Note 2: Pulse width limited by Max. junction temperature.

■ Electrical Characteristics at $T_J=25^\circ C$ (unless otherwise specified)

Symbol	Parameter	Test Conditions	Min.	Typ.	Max.	Units
BV_{DSS}	Drain-Source Breakdown Voltage	$V_{GS}=0V, I_D=250\mu A$	20	-	-	V
$\Delta BV_{DSS}/\Delta T_J$	Breakdown Voltage Temperature Coefficient	Reference to 25 $^\circ C$, $I_D=1mA$	-	0.02	-	V/ $^\circ C$
$R_{DS(on)}$	Static Drain-Source On-Resistance (Note 3)	$V_{GS}=4.5V, I_D=5A$	-	-	23	m Ω
		$V_{GS}=2.5V, I_D=2A$	-	-	29	m Ω
$V_{GS(th)}$	Gate Threshold Voltage	$V_{DS}=V_{GS}, I_D=250\mu A$	0.5	-	-	V
g_{fs}	Forward Transconductance	$V_{DS}=10V, I_D=5A$	-	21	-	S
I_{DSS}	Drain-Source Leakage Current	$V_{DS}=20V, V_{GS}=0V, T_J=25^\circ C$	-	-	1	μA
		$V_{DS}=20V, V_{GS}=0V, T_J=70^\circ C$	-	-	25	μA
I_{GSS}	Gate-Source Leakage	$V_{GS}=\pm 12V$	-	-	± 10	μA
Q_g	Total Gate Charge (Note 3)	$I_D=5A$	-	15.9	-	nC
Q_{gs}	Gate-Source Charge	$V_{DS}=10V$	-	1.5	-	nC
Q_{gd}	Gate-Drain ("Miller") Charge	$V_{GS}=4.5V$	-	7.4	-	nC
$t_{d(on)}$	Turn-On Delay Time (Note 3)	$V_{DS}=10V$	-	6.2	-	ns
t_r	Rise Time	$I_D=1A$	-	9	-	ns
$t_{d(off)}$	Turn-Off Delay Time	$R_G=3.3\Omega, V_{GS}=4.5V$	-	30	-	ns
t_f	Fall-Time	$R_D=10\Omega$	-	11	-	ns
C_{iss}	Input Capacitance	$V_{GS}=0V$	-	530	-	pF
C_{oss}	Output Capacitance	$V_{DS}=20V$	-	245	-	pF
C_{rss}	Reverse Transfer Capacitance	$f=1.0MHz$	-	125	-	pF

■ Source-Drain Diode

Symbol	Parameter	Test Conditions	Min.	Typ.	Max.	Units
I_S	Continuous Source Current (Body Diode)	$V_D=V_G=0V, V_S=1.2V$	-	-	0.83	A
V_{SD}	Forward On Voltage (Note 3)	$T_J=25^\circ C, I_S=5A, V_{GS}=0V$	-	-	1.2	V

Note3: Pulse width $\leq 300\mu s$, duty cycle $\leq 2\%$.

N-Channel Enhancement Mode Power MOSFET

Typical Performance Characteristics

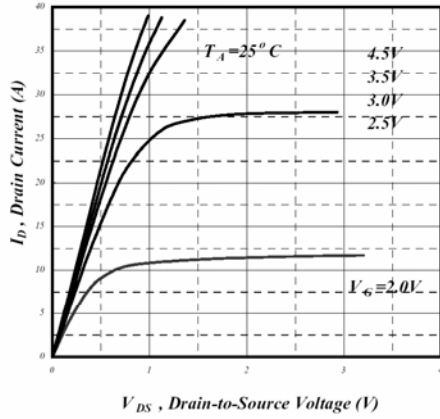

Fig 1. Typical Output Characteristics

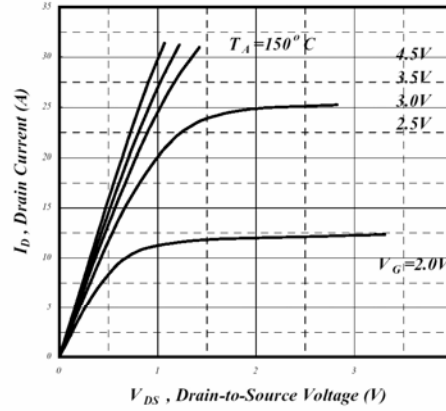

Fig 2. Typical Output Characteristics

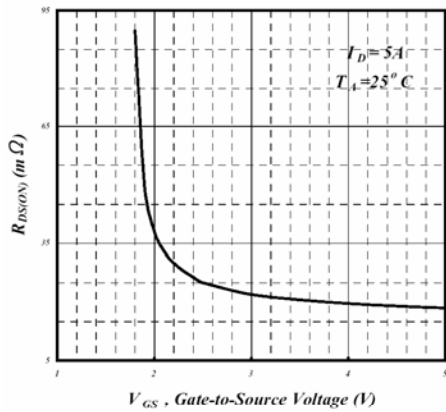

Fig 3. On-Resistance v.s. Gate Voltage

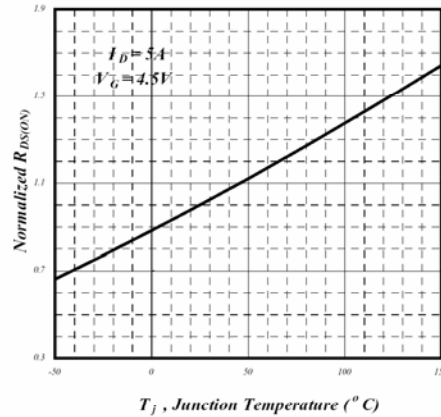

Fig 4. Normalized On-Resistance

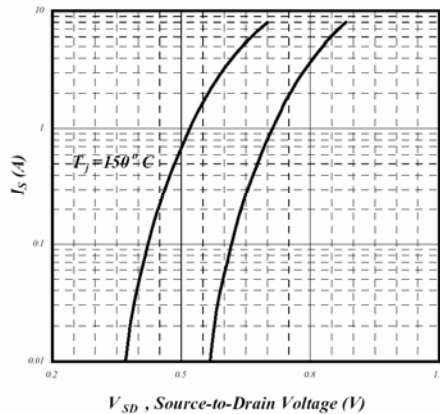

Fig 5. Forward Characteristic of Reverse Diode

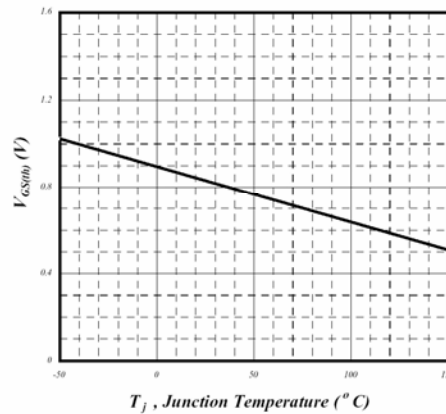

Fig 6. Gate Threshold Voltage v.s. Junction Temperature

N-Channel Enhancement Mode Power MOSFET

■ Typical Performance Characteristics (Continued)

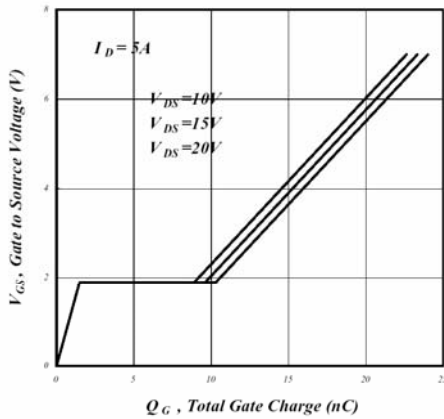

Fig 7. Gate Charge Characteristics

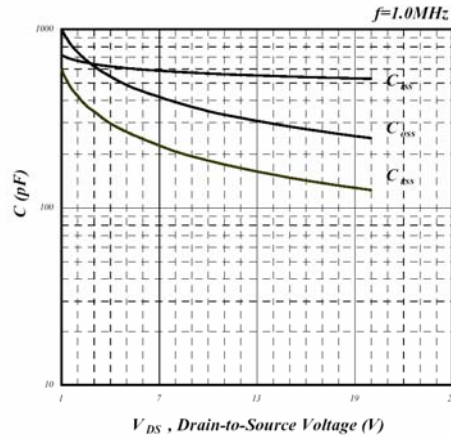

Fig 8. Typical Capacitance Characteristics

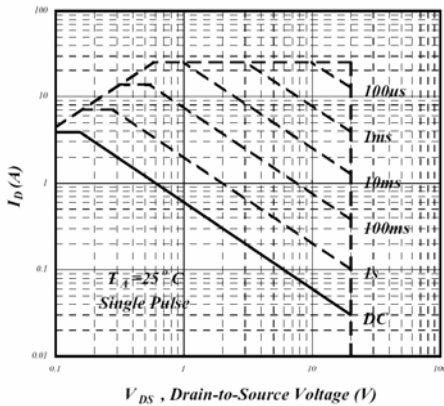

Fig 9. Maximum Safe Operating Area

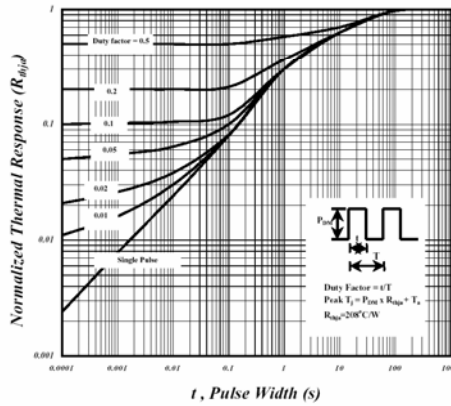

Fig 10. Effective Transient Thermal Impedance

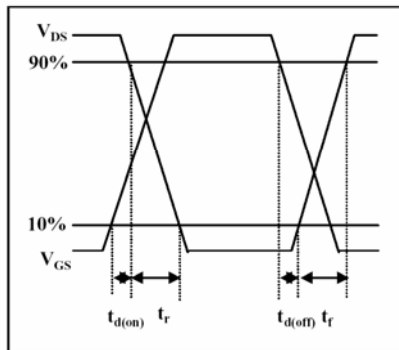

Fig 11. Switching Time Waveform

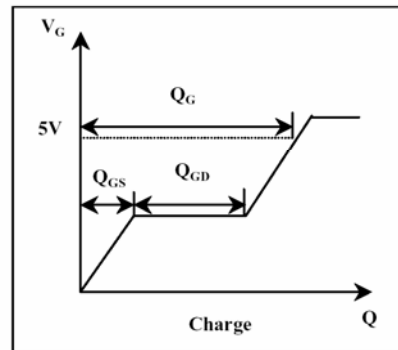
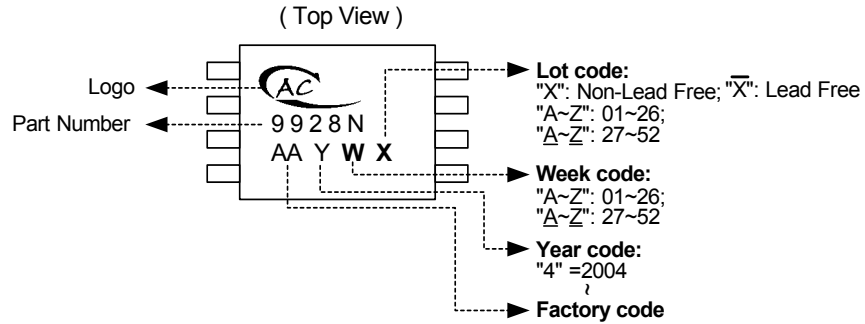

Fig 12. Gate Charge Waveform

N-Channel Enhancement Mode Power MOSFET

■ Marking Information

TSSOP-8L



■ Package Information

Package Type: TSSOP-8L

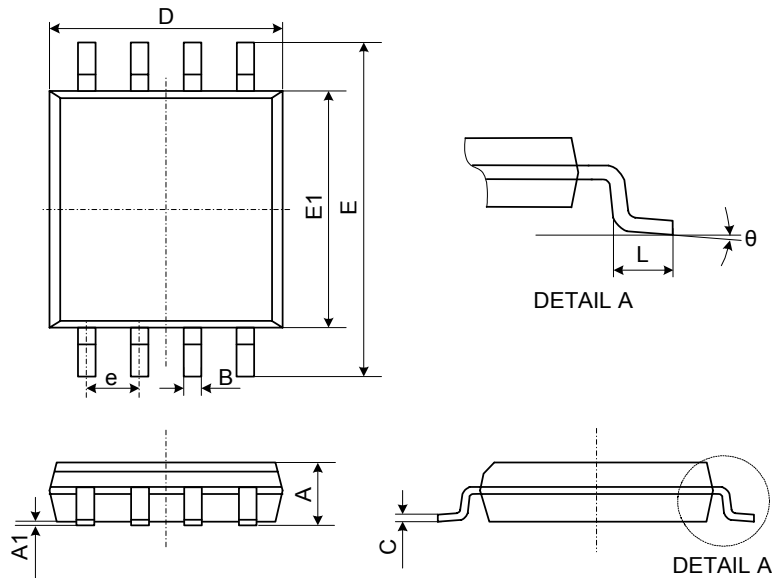

1. All Dimensions Are in Millimeters.
2. Dimension Does Not Include Mold Protrusions.

Symbol	Dimensions In Millimeters		
	Min.	Nom.	Max.
A	-	-	1.20
A1	0.05	-	0.15
B	0.19	-	0.30
C	-	0.127	-
D	2.90	3.00	3.10
E	6.20	6.40	6.60
E1	4.30	4.40	4.50
L	0.45	0.60	0.75
e	0.65 REF.		
θ	0°	--	8°