

## FEATURES

- Very Low Power:  $I_{CC} = 110\mu\text{A Typ}$
- Designed for RS485 or RS422 Applications
- Single 5V Supply
- -7V to 12V Bus Common-Mode Range Permits  $\pm 7\text{V GND}$  Difference Between Devices on the Bus
- Thermal Shutdown Protection
- Power-Up/Down Glitch-Free Driver Outputs Permit Live Insertion/Removal of Package
- Driver Maintains High Impedance in Three-State or with the Power Off
- 28ns Typical Driver Propagation Delays with 5ns Skew
- Pin Compatible with the SN75172, DS96172,  $\mu\text{A96172}$ , and DS96F172

## APPLICATIONS

- Low Power RS485/RS422 Drivers
- Level Translator

## DESCRIPTION

The LTC486 is a low power differential bus/line driver designed for multipoint data transmission standard RS485 applications with extended common-mode range (12V to -7V). It also meets RS422 requirements.

The CMOS design offers significant power savings over its bipolar counterpart without sacrificing ruggedness against overload or ESD damage.

The driver features three-state outputs, with the driver outputs maintaining high impedance over the entire common-mode range. Excessive power dissipation caused by bus contention or faults is prevented by a thermal shutdown circuit which forces the driver outputs into a high impedance state.

Both AC and DC specifications are guaranteed from 0°C to 70°C (Commercial), -40°C to 85°C (Industrial), over the 4.75V to 5.25V supply voltage range.

## TYPICAL APPLICATION

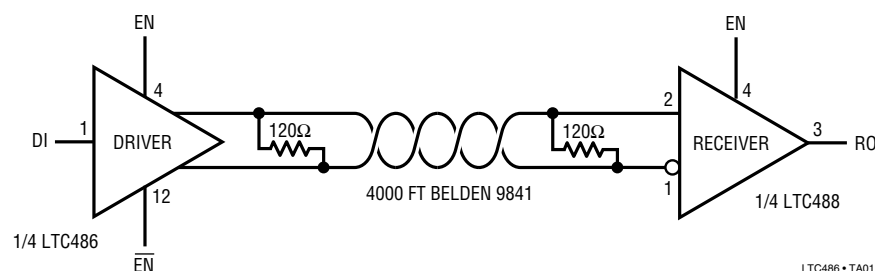

RS485 Cable Length Specification\*

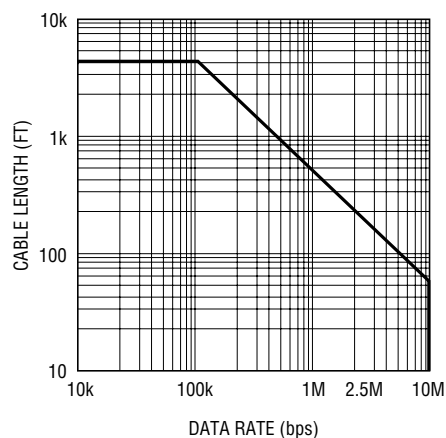

\* APPLIES FOR 24 GAUGE, POLYETHYLENE DIELECTRIC TWISTED PAIR

## ABSOLUTE MAXIMUM RATINGS

(Note 1)

Supply Voltage ( $V_{CC}$ )	12V
Control Input Voltages	-0.5V to $V_{CC} + 0.5V$
Driver Input Voltages	-0.5V to $V_{CC} + 0.5V$
Driver Output Voltages	$\pm 14V$
Control Input Currents	$\pm 25mA$
Driver Input Currents	$\pm 25mA$
Operating Temperature Range	
LTC486C	0°C to 70°C
LTC486I	-40°C to 85°C
Storage Temperature Range	-65°C to 150°C
Lead Temperature (Soldering, 10 sec)	300°C

## PACKAGE/ORDER INFORMATION

<p>N PACKAGE 16-LEAD PLASTIC DIP</p> <p>S PACKAGE 16-LEAD PLASTIC SOL</p> <p><math>T_{JMAX} = 125^{\circ}C, \theta_{JA} = 70^{\circ}C/W</math> (N) <math>T_{JMAX} = 150^{\circ}C, \theta_{JA} = 95^{\circ}C/W</math> (S)</p>	ORDER PART NUMBER
	LTC486CN LTC486CSW LTC486IN LTC486ISW

Consult factory for Military grade parts

## DC ELECTRICAL CHARACTERISTICS

$V_{CC} = 5V \pm 5\%$ , 0°C ≤ Temperature ≤ 70°C (Commercial), -40°C ≤ Temperature ≤ 85°C (Industrial) (Note 2, 3)

SYMBOL	PARAMETER	CONDITIONS	MIN	TYP	MAX	UNITS
$V_{OD1}$	Differential Driver Output Voltage (Unloaded)	$I_O = 0$			5	V
$V_{OD2}$	Differential Driver Output Voltage (With Load)	$R = 50\Omega$ ; (RS422)	2			V
		$R = 27\Omega$ ; (RS485) (Figure 1)	1.5		5	V
$V_{OD}$	Change in Magnitude of Driver Differential Output Voltage for Complementary Output States	$R = 27\Omega$ or $R = 50\Omega$ (Figure 1)			0.2	V
$V_{OC}$	Driver Common-Mode Output Voltage				3	V
$V_{OC1}$	Change in Magnitude of Driver Common-Mode Output Voltage for Complementary Output States				0.2	V
$V_{IH}$	Input High Voltage	DI, EN, $\overline{EN}$	2.0			V
$V_{IL}$	Input Low Voltage				0.8	V
$I_{IN1}$	Input Current				$\pm 2$	$\mu A$
$I_{CC}$	Supply Current	No Load		110	200	$\mu A$
		Output Enabled		110	200	$\mu A$
$I_{OSD1}$	Driver Short-Circuit Current, $V_{OUT} = \text{High}$	$V_O = -7V$		100	250	mA
$I_{OSD2}$	Driver Short-Circuit Current, $V_{OUT} = \text{Low}$	$V_O = 12V$		100	250	mA
$I_{OZ}$	High Impedance State Output Current	$V_O = -7V$ to $12V$		$\pm 10$	$\pm 200$	$\mu A$

## SWITCHING CHARACTERISTICS

$V_{CC} = 5V \pm 5\%$ , 0°C ≤ Temperature ≤ 70°C (Commercial), -40°C ≤ Temperature ≤ 85°C (Industrial) (Note 2, 3)

SYMBOL	PARAMETER	CONDITIONS	MIN	TYP	MAX	UNITS
$t_{PLH}$	Driver Input to Output	$R_{DIFF} = 54\Omega, C_{L1} = C_{L2} = 100pF$ (Figures 2, 4)	10	30	50	ns
$t_{PHL}$	Driver Input to Output		10	30	50	ns
$t_{SKEW}$	Driver Output to Output			5	15	ns
$t_r, t_f$	Driver Rise or Fall Time		5	15	25	ns
$t_{ZH}$	Driver Enable to Output High	$C_L = 100pF$ (Figures 3, 5) S2 Closed		35	70	ns

## SWITCHING CHARACTERISTICS

$V_{CC} = 5V \pm 5\%$ ,  $0^\circ C \leq \text{Temperature} \leq 70^\circ C$  (Commercial),  $-40^\circ C \leq \text{Temperature} \leq 85^\circ C$  (Industrial) (Note 2, 3)

SYMBOL	PARAMETER	CONDITIONS	MIN	TYP	MAX	UNITS
$t_{ZL}$	Driver Enable to Output Low	$C_L = 100pF$ (Figures 3, 5) S1 Closed		35	70	ns
$t_{LZ}$	Driver Disable Time from Low	$C_L = 15pF$ (Figures 3, 5) S1 Closed		35	70	ns
$t_{HZ}$	Driver Disable Time from High	$C_L = 15pF$ (Figures 3, 5) S2 Closed		35	70	ns

**Note 1:** Absolute maximum ratings are those beyond which the safety of the device cannot be guaranteed.

**Note 2:** All currents into device pins are positive; all currents out of device

pins are negative. All voltages are referenced to device ground unless otherwise specified.

**Note 3:** All typicals are given for  $V_{CC} = 5V$  and temperature =  $25^\circ C$ .

## SWITCHING TIME WAVEFORMS

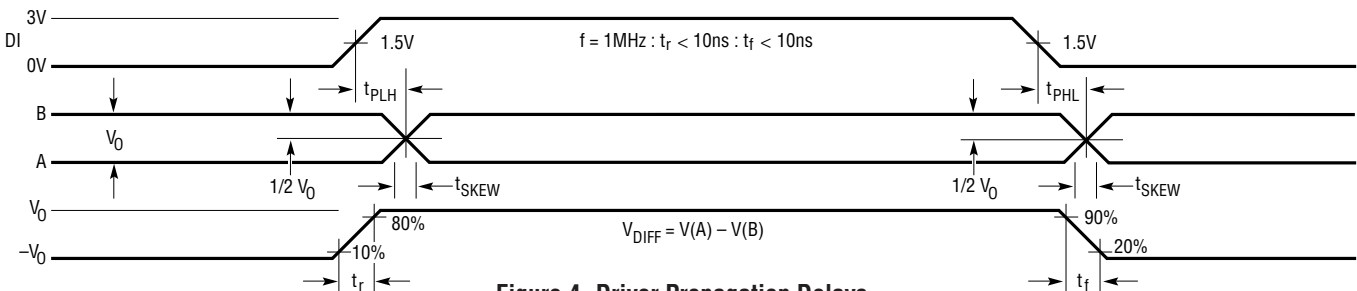

Figure 4. Driver Propagation Delays

LTC486 • TA05

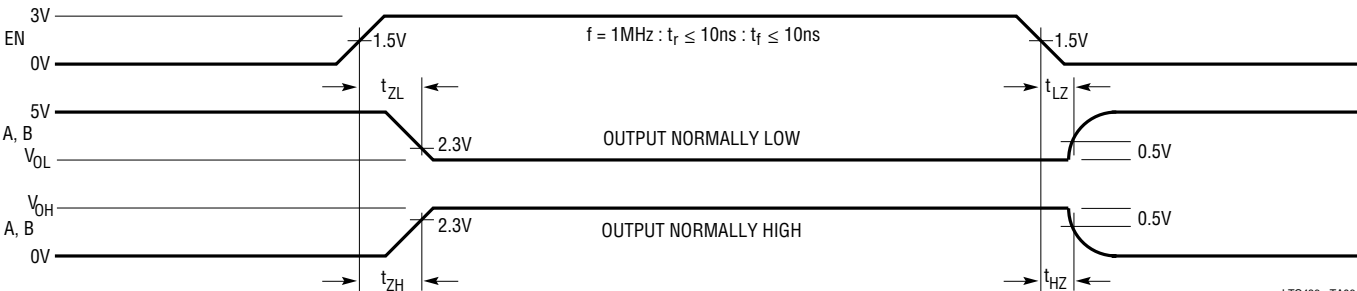
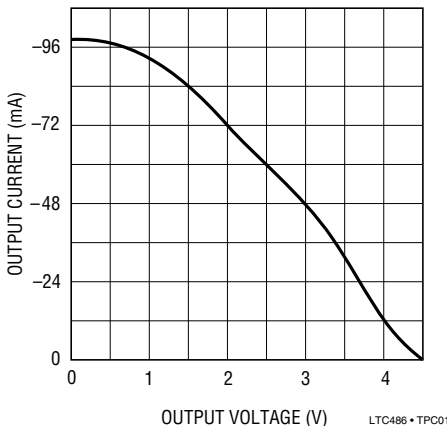

Figure 5. Driver Enable and Disable Times

LTC486 • TA06

## TYPICAL PERFORMANCE CHARACTERISTICS

Driver Output High Voltage vs Output Current  $T_A = 25^\circ C$



LTC486 • TPC01

Driver Differential Output Voltage vs Output Current  $T_A = 25^\circ C$

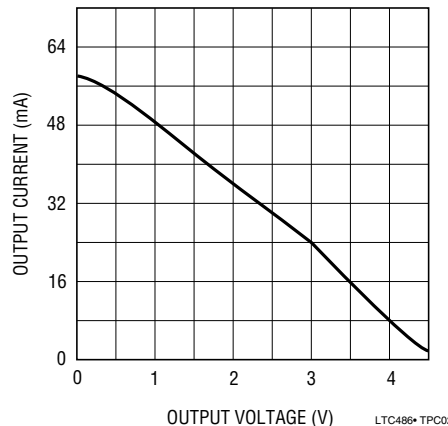

LTC486 • TPC02

Driver Output Low Voltage vs Output Current  $T_A = 25^\circ C$

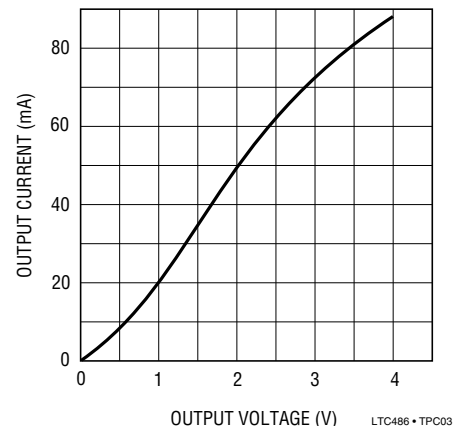

LTC486 • TPC03

## TYPICAL PERFORMANCE CHARACTERISTICS

TTL Input Threshold vs Temperature

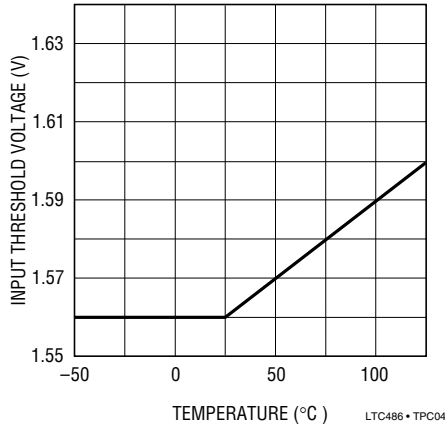

Driver Skew vs Temperature

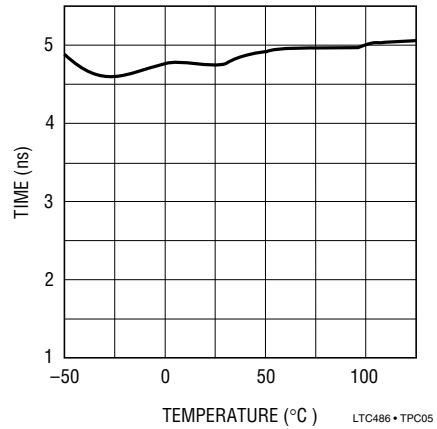

Supply Current vs Temperature

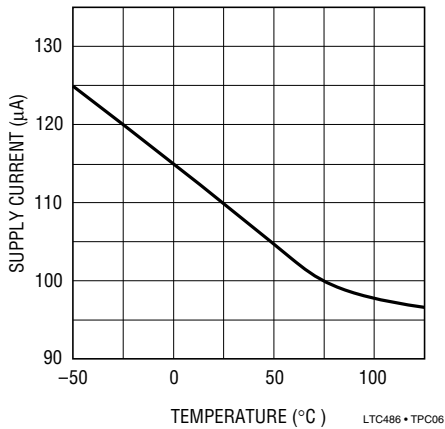

Driver Differential Output Voltage vs Temperature  $R_0 = 54\Omega$

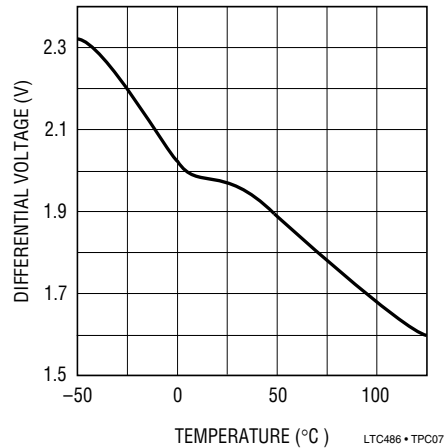

## FUNCTION TABLE

INPUT	ENABLES		OUTPUTS	
	EN	$\overline{\text{EN}}$	OUTA	OUTB
H	H	X	H	L
L	H	X	L	H
H	X	L	H	L
L	X	L	L	H
X	L	H	Z	Z

H: High Level  
 L: Low Level  
 X: Irrelevant  
 Z: High Impedance (Off)

## PIN FUNCTIONS

**DI1 (Pin 1):** Driver 1 Input. If Driver 1 is enabled, then a low on DI1 forces the driver outputs DO1A low and DO1B high. A high on DI1 with the driver outputs enabled will force DO1A high and DO1B low.

**DO1A (Pin 2):** Driver 1 Output.

**DO1B (Pin 3):** Driver 1 Output.

**EN (Pin 4):** Driver Outputs Enabled. See Function Table for details.

**DO2B (Pin 5):** Driver 2 Output.

**DO2A (Pin 6):** Driver 2 Output.

**DI2 (Pin 7):** Driver 2 Input. Refer to DI1.

**GND (Pin 8):** Ground Connection.

**DI3 (Pin 9):** Driver 3 Input. Refer to DI1.

**DO3A (Pin 10):** Driver 3 Output.

**DO3B (Pin 11):** Driver 3 Output.

**$\overline{\text{EN}}$  (Pin 12):** Driver Outputs Disabled. See Function Table for details.

**DO4B (Pin 13):** Driver 4 Output.

**DO4A (Pin 14):** Driver 4 Output.

**DI4 (Pin 15):** Driver 4 Input. Refer to DI1.

**V<sub>CC</sub> (Pin 16):** Positive Supply;  $4.75\text{V} < V_{\text{CC}} < 5.25\text{V}$ .

## TEST CIRCUITS

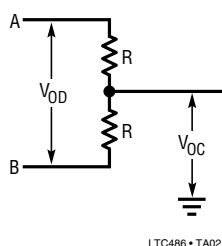

Figure 1. Driver DC Test Load

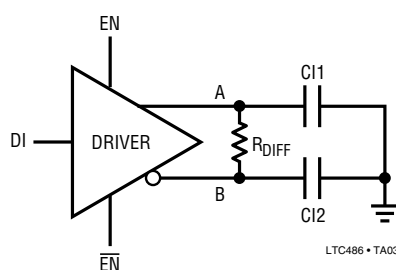

Figure 2. Driver Timing Test Circuit

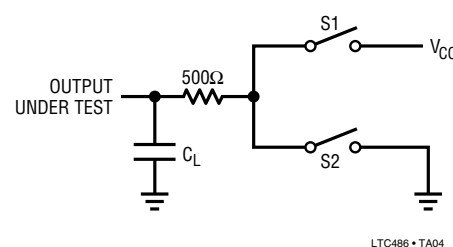

Figure 3. Driver Timing Test Load #2

## APPLICATIONS INFORMATION

### Typical Application

A typical connection of the LTC486 is shown in Figure 6. A twisted pair of wires connect up to 32 drivers and receivers for half duplex data transmission. There are no restrictions on where the chips are connected to the wires, and it isn't necessary to have the chips connected at the ends. However, the wires must be terminated only at the ends with a resistor equal to their characteristic impedance, typically  $120\Omega$ . The optional shields around the twisted pair help reduce unwanted noise, and are connected to GND at one end.

### Thermal Shutdown

The LTC486 has a thermal shutdown feature which protects the part from excessive power dissipation. If the outputs of the driver are accidentally shorted to a power

supply or low impedance source, up to 250mA can flow through the part. The thermal shutdown circuit disables the driver outputs when the internal temperature reaches  $150^\circ\text{C}$  and turns them back on when the temperature cools to  $130^\circ\text{C}$ . If the outputs of two or more LTC486 drivers are shorted directly, the driver outputs can not supply enough current to activate the thermal shutdown. Thus, the thermal shutdown circuit will not prevent contention faults when two drivers are active on the bus at the same time.

### Cable and Data Rate

The transmission line of choice for RS485 applications is a twisted pair. There are coaxial cables (twinaxial) made for this purpose that contain straight pairs, but these are less flexible, more bulky, and more costly than twisted pairs. Many cable manufacturers offer a broad range of  $120\Omega$  cables designed for RS485 applications.

APPLICATIONS INFORMATION

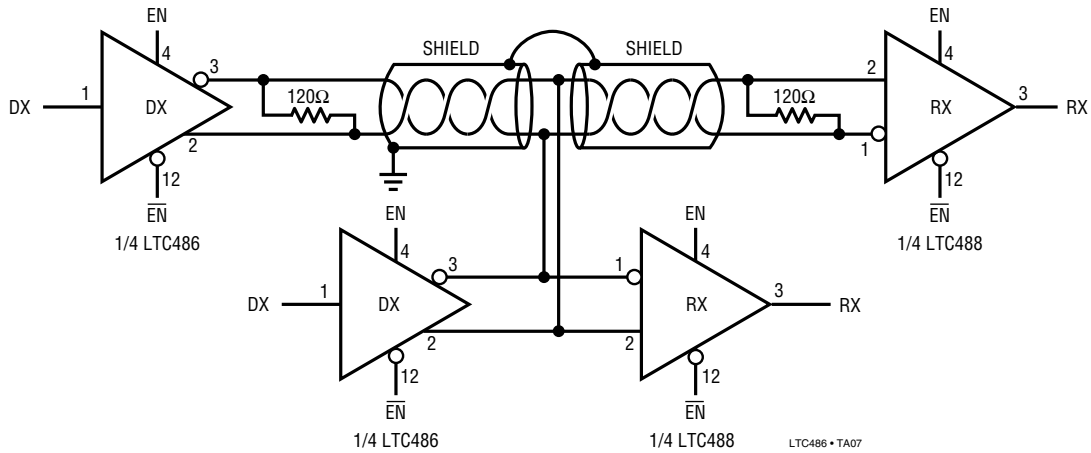

Figure 6. Typical Connection

Losses in a transmission line are a complex combination of DC conductor loss, AC losses (skin effect), leakage, and AC losses in the dielectric. In good polyethylene cables such as the Belden 9841, the conductor losses and dielectric losses are of the same order of magnitude, with relatively low overall loss (Figure 7).

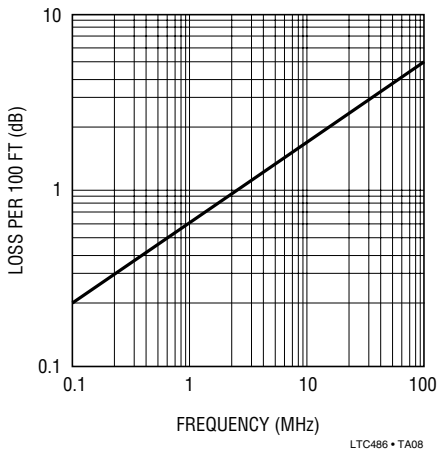

Figure 7. Attenuation vs Frequency for Belden 9841

When using low loss cables, Figure 8 can be used as a guideline for choosing the maximum line length for a given data rate. With lower quality PVC cables, the dielectric loss factor can be 1000 times worse. PVC twisted pairs have terrible losses at high data rates (>100kbs) and greatly reduce the maximum cable length. At low data rates however, they are acceptable and much more economical.

Cable Termination

The proper termination of the cable is very important. If the cable is not terminated with its characteristic impedance,

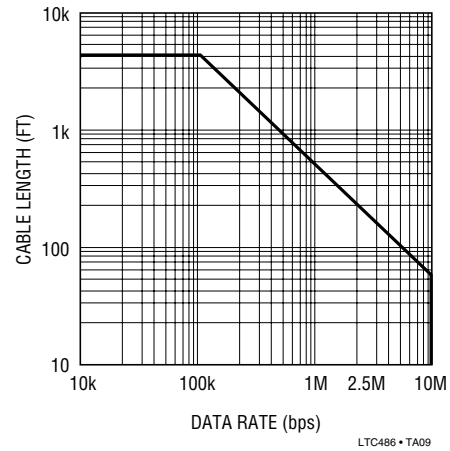

Figure 8. Cable Length vs Data Rate

distorted waveforms will result. In severe cases, distorted (false) data and nulls will occur. A quick look at the output of the driver will tell how well the cable is terminated. It is best to look at a driver connected to the end of the cable, since this eliminates the possibility of getting reflections from two directions. Simply look at the driver output while transmitting square wave data. If the cable is terminated properly, the waveform will look like a square wave (Figure 9).

If the cable is loaded excessively (e.g., 47Ω), the signal initially sees the surge impedance of the cable and jumps to an initial amplitude. The signal travels down the cable and is reflected back out of phase because of the mistermiation. When the reflected signal returns to the driver, the amplitude will be lowered. The width of the pedestal is equal to twice the electrical length of the cable (about 1.5ns/ft). If the cable is lightly loaded (e.g., 470Ω),

## APPLICATIONS INFORMATION

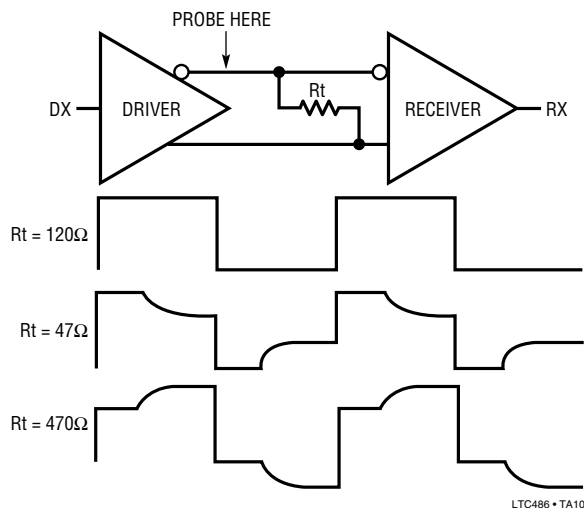

Figure 9. Termination Effects

the signal reflects in phase and increases the amplitude at the driver output. An input frequency of 30kHz is adequate for tests out to 4000 ft. of cable.

## AC Cable Termination

Cable termination resistors are necessary to prevent unwanted reflections, but they consume power. The typical differential output voltage of the driver is 2V when the cable is terminated with two 120Ω resistors. When no data is being sent 33mA of DC current flows in the cable. This DC current is about 220 times greater than the supply current of the LTC486. One way to eliminate the unwanted current is by AC coupling the termination resistors as shown in Figure 10.

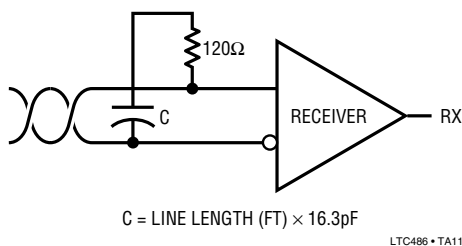

Figure 10. AC Coupled Termination

The coupling capacitor allows high frequency energy to flow to the termination, but blocks DC and low frequencies. The dividing line between high and low frequency depends on the length of the cable. The coupling capacitor must pass frequencies above the point where the line

represents an electrical one-tenth wavelength. The value of the coupling capacitor should therefore be set at 16.3pF per foot of cable length for 120Ω cables. With the coupling capacitors in place, power is consumed only on the signal edges, not when the driver output is idling at a 1 or 0 state. A 100nF capacitor is adequate for lines up to 4000 feet in length. Be aware that the power savings start to decrease once the data rate surpasses  $1/(120\Omega \times C)$ .

## Receiver Open-Circuit Fail-Safe

Some data encoding schemes require that the output of the receiver maintains a known state (usually a logic 1) when the data is finished transmitting and all drivers on the line are forced into three-state. All LTC RS485 receivers have a fail-safe feature which guarantees the output to be in a logic 1 state when the receiver inputs are left floating (open-circuit). However, when the cable is terminated with 120Ω, the differential inputs to the receiver are shorted together, not left floating.

If the receiver output must be forced to a known state, the circuits of Figure 11 can be used.

The termination resistors are used to generate a DC bias which forces the receiver output to a known state, in this case a logic 0. The first method consumes about 208mW and the second about 8mW. The lowest power

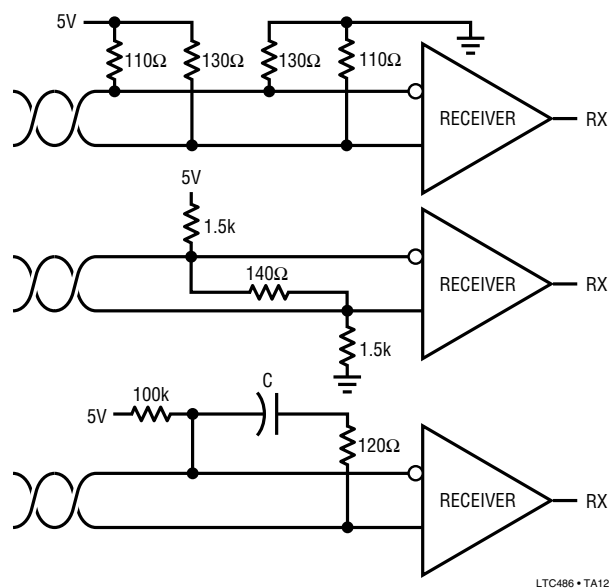

Figure 11. Forcing "0" When All Drivers Are Off

## APPLICATIONS INFORMATION

solution is to use an AC termination with a pull-up resistor. Simply swap the receiver inputs for data protocols ending in logic 1.

### Fault Protection

All of LTC's RS485 products are protected against ESD transients up to ±2kV using the human body model (100pF, 1.5kΩ). However, some applications need greater protection. The best protection method is to connect a bidirectional TransZorb® from each line side pin to ground (Figure 12).

A TransZorb® is a silicon transient voltage suppressor that has exceptional surge handling capabilities, fast response time, and low series resistance. They are available from General Semiconductor Industries and come in a variety of

breakdown voltages and prices. Be sure to pick a breakdown voltage higher than the common-mode voltage required for your application (typically 12V). Also, don't forget to check how much the added parasitic capacitance will load down the bus.

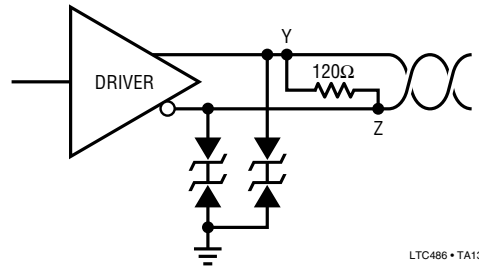
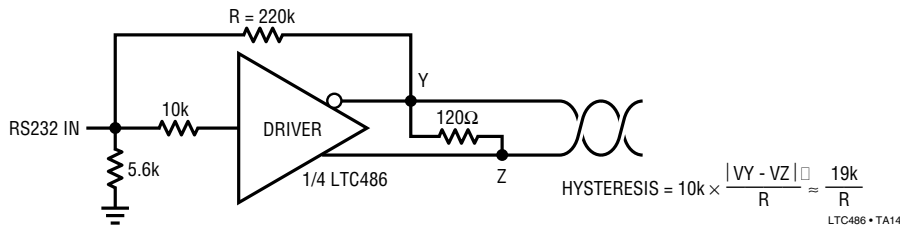

Figure 12. ESD Protection

TransZorb® is a registered trademark of General Instruments, GSI

## TYPICAL APPLICATION

### RS232 to RS485 Level Translator with Hysteresis



## PACKAGE DESCRIPTION

Dimensions in inches (millimeters) unless otherwise noted.

### N Package 16-Lead Plastic DIP

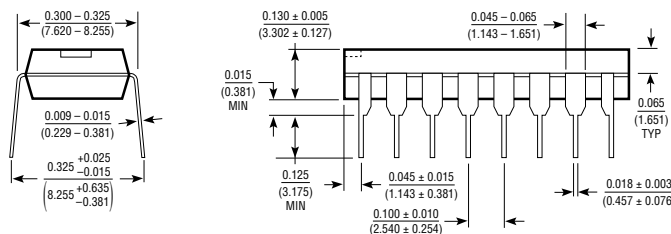

### S Package 16-Lead Plastic SOL

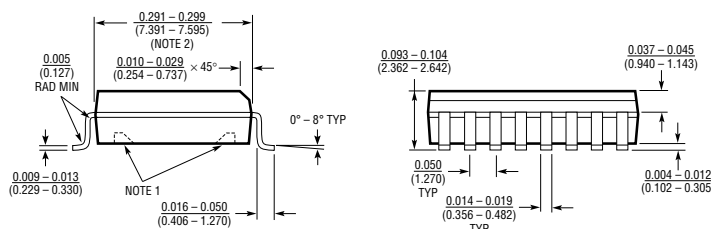

- NOTE:  
 1. PIN 1 IDENT, NOTCH ON TOP AND CAVITIES ON THE BOTTOM OF PACKAGES ARE THE MANUFACTURING OPTIONS. THE PART MAY BE SUPPLIED WITH OR WITHOUT ANY OF THE OPTIONS.  
 2. THESE DIMENSIONS DO NOT INCLUDE MOLD FLASH OR PROTRUSIONS. MOLD FLASH OR PROTRUSIONS SHALL NOT EXCEED 0.006 INCH (0.15mm).

