



CED4204/CEU4204

N-Channel Enhancement Mode Field Effect Transistor

FEATURES

- 40V, 24A, $R_{DS(ON)} = 30m\Omega$ @ $V_{GS} = 10V$.
 $R_{DS(ON)} = 45m\Omega$ @ $V_{GS} = 4.5V$.
- Super high dense cell design for extremely low $R_{DS(ON)}$.
- High power and current handling capability.
- Lead free product is acquired.
- TO-251 & TO-252 package.



ABSOLUTE MAXIMUM RATINGS $T_C = 25^\circ C$ unless otherwise noted

Parameter	Symbol	Limit	Units
Drain-Source Voltage	V_{DS}	40	V
Gate-Source Voltage	V_{GS}	± 20	V
Drain Current-Continuous	I_D	24	A
Drain Current-Pulsed ^a	I_{DM}	90	A
Maximum Power Dissipation @ $T_C = 25^\circ C$ - Derate above $25^\circ C$	P_D	31	W
		0.25	W/ $^\circ C$
Operating and Store Temperature Range	T_J, T_{stg}	-55 to 150	$^\circ C$

Thermal Characteristics

Parameter	Symbol	Limit	Units
Thermal Resistance, Junction-to-Case	$R_{\theta JC}$	4	$^\circ C/W$
Thermal Resistance, Junction-to-Ambient	$R_{\theta JA}$	50	$^\circ C/W$



CED4204/CEU4204

Electrical Characteristics $T_C = 25^\circ\text{C}$ unless otherwise noted

Parameter	Symbol	Test Condition	Min	Typ	Max	Units
Off Characteristics						
Drain-Source Breakdown Voltage	BV_{DSS}	$V_{GS} = 0V, I_D = 250\mu A$	40			V
Zero Gate Voltage Drain Current	I_{DSS}	$V_{DS} = 32V, V_{GS} = 0V$			1	μA
Gate Body Leakage Current, Forward	I_{GSSF}	$V_{GS} = 20V, V_{DS} = 0V$			100	nA
Gate Body Leakage Current, Reverse	I_{GSSR}	$V_{GS} = -20V, V_{DS} = 0V$			-100	nA
On Characteristics						
Gate Threshold Voltage	$V_{GS(th)}$	$V_{GS} = V_{DS}, I_D = 250\mu A$	1		3	V
Static Drain-Source On-Resistance	$R_{DS(on)}$	$V_{GS} = 10V, I_D = 6A$		24	30	$m\Omega$
		$V_{GS} = 4.5V, I_D = 5A$		34	45	$m\Omega$
Dynamic Characteristics ^c						
Forward Transconductance	g_{FS}^b	$V_{DS} = 5V, I_D = 6A$		10		S
Input Capacitance	C_{iss}	$V_{DS} = 20V, V_{GS} = 0V, f = 1.0\text{ MHz}$		1050		pF
Output Capacitance	C_{oss}			155		pF
Reverse Transfer Capacitance	C_{rss}			95		pF
Switching Characteristics ^c						
Turn-On Delay Time	$t_{d(on)}$	$V_{DD} = 20V, I_D = 6A, V_{GS} = 10V, R_{GEN} = 3\Omega$		14	30	ns
Turn-On Rise Time	t_r			10	20	ns
Turn-Off Delay Time	$t_{d(off)}$			17	35	ns
Turn-Off Fall Time	t_f			18	35	ns
Total Gate Charge	Q_g	$V_{DS} = 20V, I_D = 6A, V_{GS} = 10V$		20.5	27	nC
Gate-Source Charge	Q_{gs}			3.5		nC
Gate-Drain Charge	Q_{gd}			4.0		nC
Drain-Source Diode Characteristics and Maximum Ratings						
Drain-Source Diode Forward Current	I_S				24	A
Drain-Source Diode Forward Voltage ^b	V_{SD}	$V_{GS} = 0V, I_S = 1A$			1.2	V
Notes : □ a.Repetitive Rating : Pulse width limited by maximum junction temperature. b.Pulse Test : Pulse Width $\leq 300\mu s$, Duty Cycle $\leq 2\%$. □ c.Guaranteed by design, not subject to production testing. □						



CED4204/CEU4204

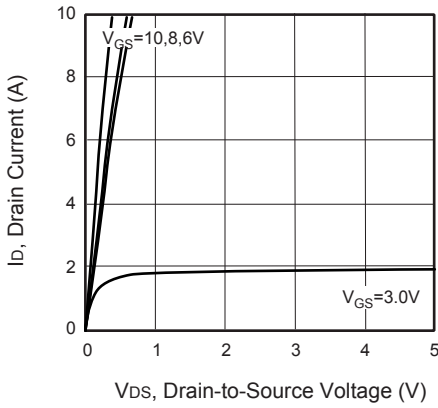

Figure 1. Output Characteristics

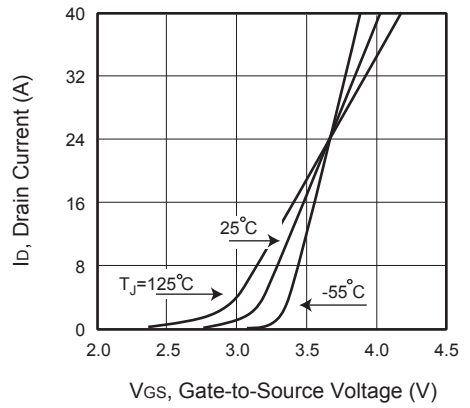

Figure 2. Transfer Characteristics

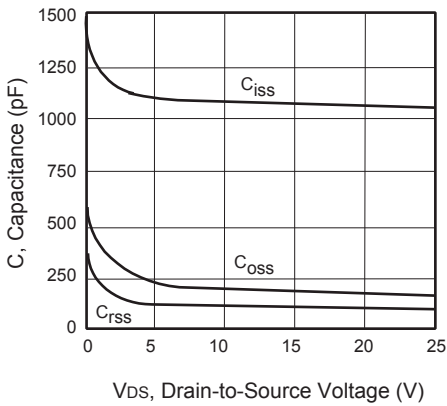

Figure 3. Capacitance

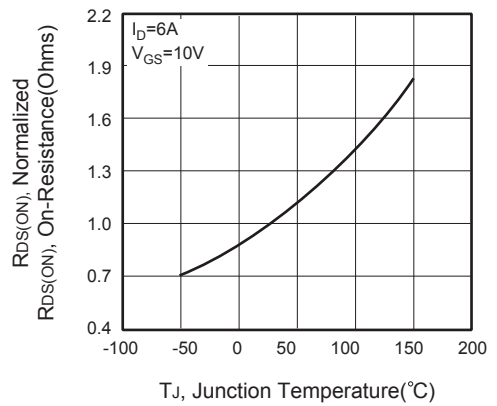

Figure 4. On-Resistance Variation with Temperature



Figure 5. Gate Threshold Variation with Temperature

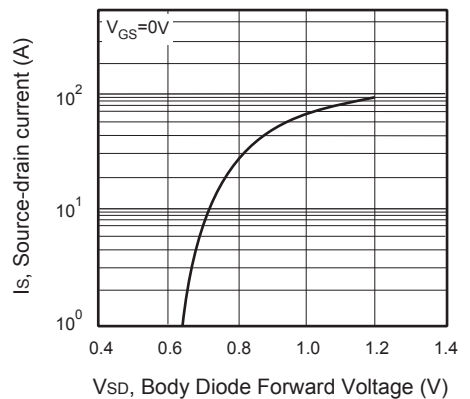

Figure 6. Body Diode Forward Voltage Variation with Source Current

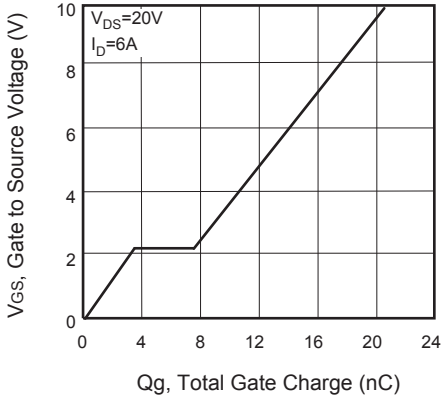

Figure 7. Gate Charge

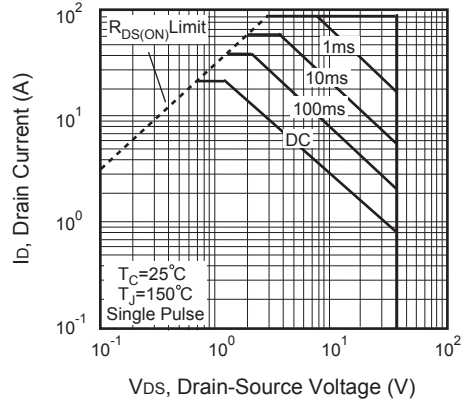

Figure 8. Maximum Safe Operating Area



Figure 9. Switching Test Circuit

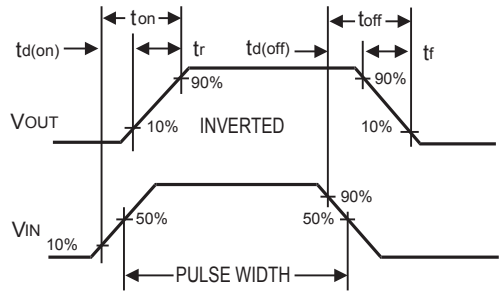

Figure 10. Switching Waveforms

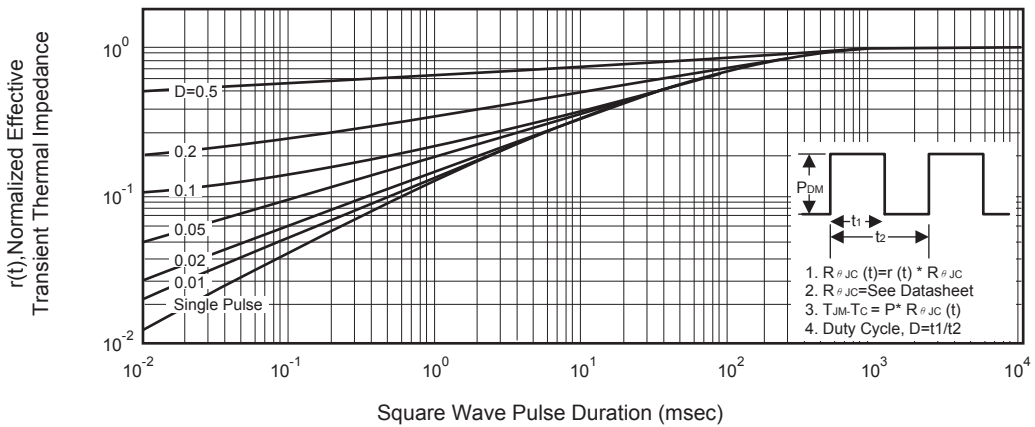

Figure 11. Normalized Thermal Transient Impedance Curve