

Monolithic Amplifier

DC-6 GHz

Product Features

- DC to 6 GHz
- Fixed 5V operation
- High Gain, 24 dB typ. at 100 MHz
- High IP3, 37 dBm typ.
- High Pout, P1dB 20.5dBm typ
- Unconditionally stable
- Transient protected
- Excellent ESD Protection
- Protected by US patent 6,943,629

**GVA-84+**

+ RoHS compliant in accordance with EU Directive (2002/95/EC)

The +Suffix has been added in order to identify RoHS Compliance. See our web site for RoHS Compliance methodologies and qualifications.

Typical Applications

- Base station infrastructure
- Portable Wireless
- CATV & DBS
- MMDS & Wireless LAN

General Description

GVA-84+ (RoHS compliant) is a wideband amplifier offering high dynamic range. Lead finish is SnAgNi. It has repeatable performance from lot to lot and is enclosed in a SOT-89 package. It uses patented Transient Protected Darlington configuration and is fabricated using InGaP HBT technology. Expected MTBF is 1200 years at 85°C case temperature. GVA-84+ is designed to be rugged for ESD and supply switch-on transients.

simplified schematic and pin description

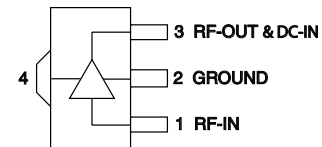
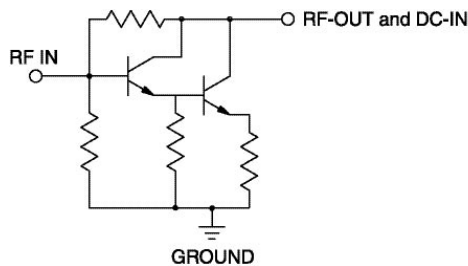

Function	Pin Number	Description
RF IN	1	RF input pin. This pin requires the use of an external DC blocking capacitor chosen for the frequency of operation.
RF-OUT and DC-IN	3	RF output and bias pin. DC voltage is present on this pin; therefore a DC blocking capacitor is necessary for proper operation. An RF choke is needed to feed DC bias without loss of RF signal due to the bias connection, as shown in "Recommended Application Circuit".
GROUND	2,4	Connections to ground. Use via holes as shown in "Suggested Layout for PCB Design" to reduce ground path inductance for best performance.

Electrical Specifications at 25°C and 5V, unless noted

Parameter		Min.	Typ.	Max.	Units	Cpk
Frequency Range		DC		6	GHz	
Gain	f=0.1GHz	22.9	24.1	25.3	dB	≥1.5
	f=1 GHz		21.7			
	f=2 GHz	17.4	18.4	19.9		
	f=3 GHz		16.0			
	f=4 GHz	13.8	14.6	16.3		
	f=6 GHz		12.5			
Magnitude of Gain Variation versus Temperature (values are negative)	f=0.1GHz		.0004	.006	dB/°C	
	f=1 GHz		.0021			
	f=2 GHz		.0032			
	f=3 GHz		.0044			
	f=4 GHz		.0058			
	f=6 GHz		.0131			
Input Return Loss	f=0.1 GHz	15	22.9		dB	
	f=1 GHz		20.6			
	f=2 GHz		18.5			
	f=3 GHz		18.1			
	f=4 GHz		19.1			
	f=6 GHz		17.9			
Output Return Loss	f=0.1 GHz	6	23.3		dB	
	f=1 GHz		10.7			
	f=2 GHz		7.7			
	f=3 GHz		7.1			
	f=4 GHz		7.0			
	f=6 GHz		6.3			
Reverse Isolation	f=2 GHz		26.5		dB	
Output Power @1 dB compression	f=0.1 GHz	19.4	20.4		dBm	≥1.5
	f=1 GHz	19.5	20.5			
	f=2 GHz	19.6	20.6			
	f=3 GHz		21.0			
	f=4 GHz		19.9			
	f=6 GHz		17.0			
Saturated Output Power (at 3dB compression)	f=0.1 GHz		21.7		dBm	
	f=1 GHz		22.3			
	f=2 GHz		22.3			
	f=3 GHz		22.2			
	f=4 GHz		21.0			
	f=6 GHz		18.9			
Output IP3	f=0.1 GHz	33	36.7		dBm	≥1.5
	f=1 GHz	32.2	35.8			
	f=2 GHz	32.9	36.6			
	f=3 GHz		35.8			
	f=4 GHz		34.9			
	f=6 GHz		33.0			
Noise Figure	f=0.1 GHz		5.5	6.5	dB	≥1.5
	f=1 GHz		5.6			
	f=2 GHz		5.5	6.5		
	f=3 GHz		5.5			
	f=4 GHz		5.6	6.6		
	f=6 GHz		6.2			

Electrical Specifications at 25°C and 5V, unless noted

Parameter	Min.	Typ.	Max.	Units	Cpk
Group Delay		94		psec	
Recommended Device Operating Voltage	4.8	5.0	5.2	V	
Device Operating Current	85	108	130	mA	
Device Current Variation vs. Temperature at 5V		61.8		$\mu A/^{\circ}C$	
Device Current Variation vs. Voltage at 25°C		0.058		mA/mV	
Thermal Resistance, junction-to-case ¹		64		$^{\circ}C/W$	

Absolute Maximum Ratings

Parameter	Ratings
Operating Temperature*	-45°C to 85°C
Storage Temperature	-65°C to 150°C
Operating Current	160 mA
Power Dissipation	1W
Input Power	13 dBm

Note: Permanent damage may occur if any of these limits are exceeded.
 These ratings are not intended for continuous normal operation.
¹Case is defined as ground leads.
 *Based on typical case temperature rise 10°C above ambient.

Typical Performance Curves

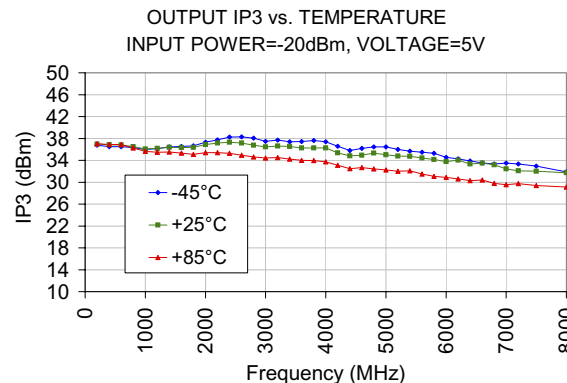
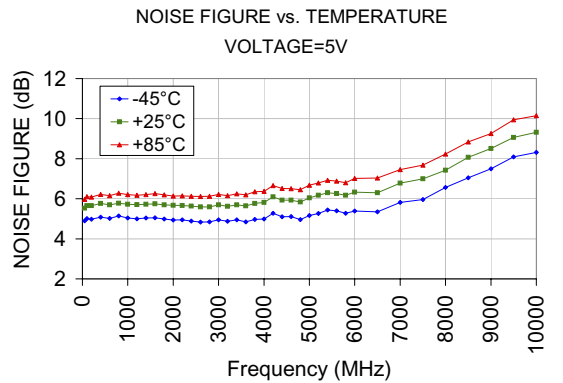
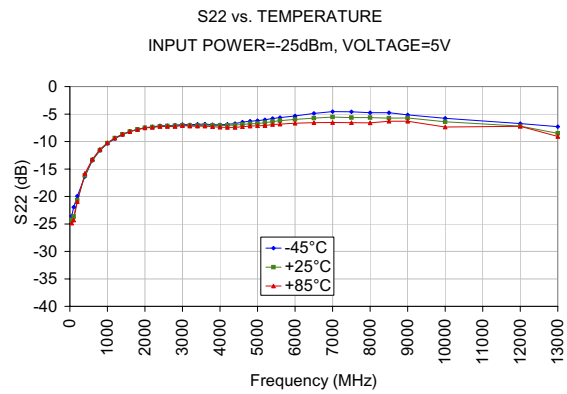
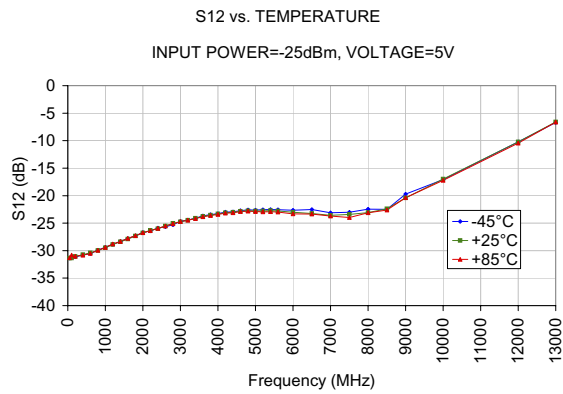
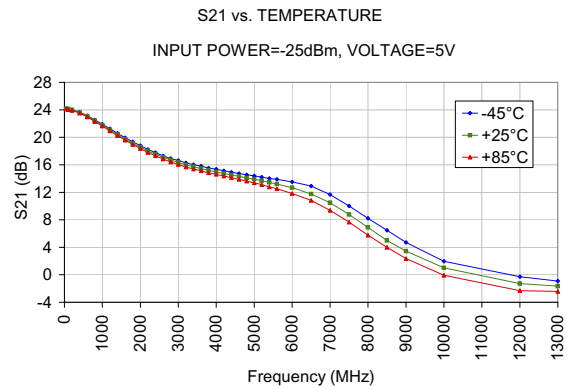
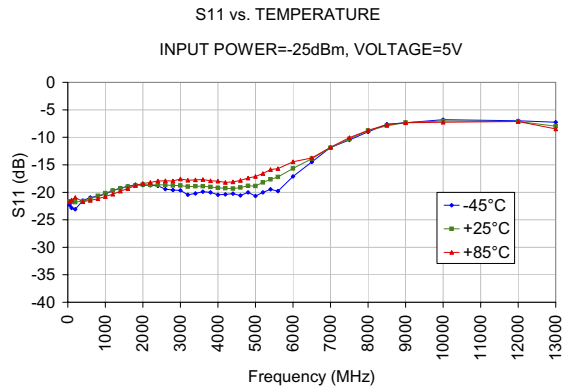

POWER OUTPUT at 1dB COMPRESSION vs. TEMPERATURE
VOLTAGE=5V

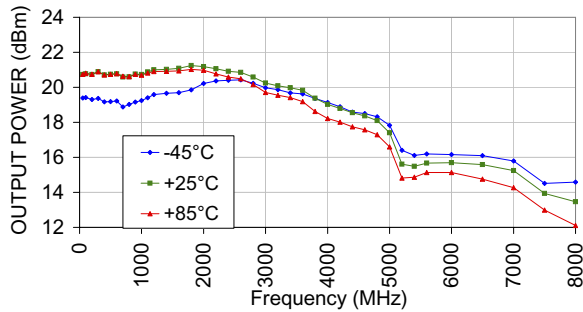

POWER OUTPUT at 1dB COMPRESSION vs. VOLTAGE
Temperature=+25°C

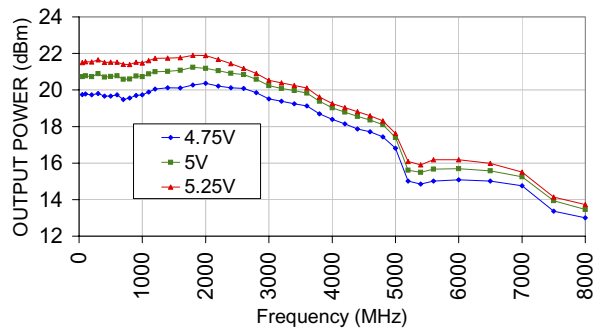

S11 vs. VOLTAGE
INPUT POWER=-25dBm, Temperature=+25°C

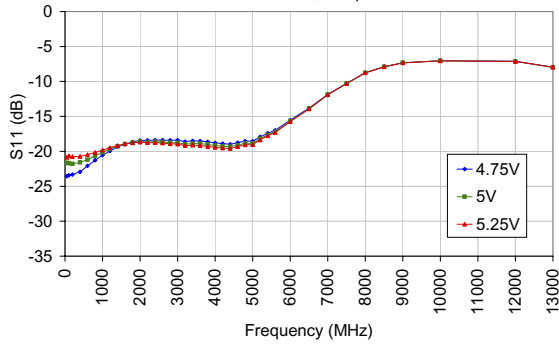

S21 vs. VOLTAGE
INPUT POWER=-25dBm @Temperature=+25°C

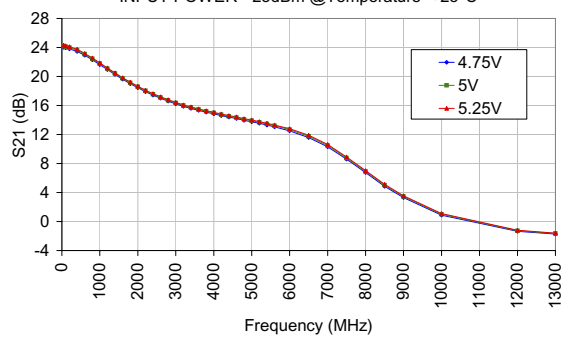

S12 vs. VOLTAGE
INPUT POWER=-25dBm, Temperature=+25°C

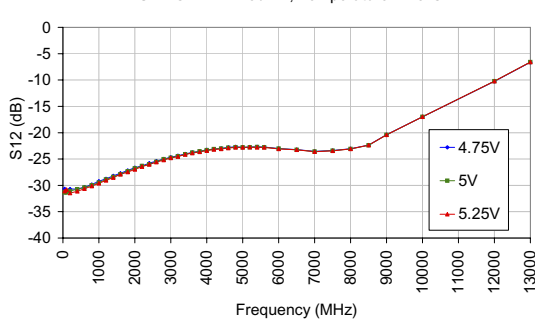

S22 vs. VOLTAGE
INPUT POWER=-25dBm @Temperature=+25°C

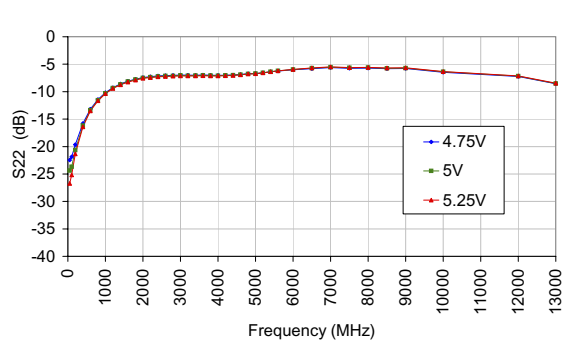

S-Parameters at 5V, 25°C

FREQ MHz	S11			S21			S12			S22		K	
	dB	Mag	Angle	dB	Mag	Angle	dB	Mag	Angle	dB	Mag		Angle
50	-21.65	0.08	172.61	24.18	16.18	172.24	-31.36	0.03	2.31	-24.37	0.06	-19.46	1.34
100	-21.72	0.08	170.08	24.11	16.05	165.43	-31.36	0.03	-4.71	-23.67	0.07	-46.14	1.35
200	-21.79	0.08	166.92	23.98	15.81	151.61	-31.07	0.03	-7.66	-20.65	0.09	-81.31	1.33
400	-21.59	0.08	153.31	23.62	15.17	124.29	-30.73	0.03	-16.97	-16.17	0.16	-123.40	1.32
600	-21.19	0.09	140.65	23.07	14.24	97.82	-30.40	0.03	-27.37	-13.38	0.21	-154.53	1.31
800	-20.64	0.09	126.85	22.44	13.24	72.39	-29.97	0.03	-36.29	-11.57	0.26	178.12	1.31
1000	-20.14	0.10	112.63	21.77	12.26	48.03	-29.47	0.03	-47.37	-10.29	0.31	153.36	1.30
1200	-19.70	0.10	97.88	21.08	11.32	24.57	-28.90	0.04	-59.96	-9.36	0.34	130.29	1.28
1400	-19.28	0.11	84.10	20.41	10.48	1.92	-28.38	0.04	-72.08	-8.68	0.37	108.42	1.27
1600	-18.96	0.11	69.51	19.75	9.72	-20.12	-27.89	0.04	-85.60	-8.17	0.39	87.84	1.27
1800	-18.76	0.12	56.10	19.12	9.04	-41.56	-27.33	0.04	-98.51	-7.80	0.41	68.15	1.26
2000	-18.60	0.12	43.02	18.57	8.48	-62.56	-26.79	0.05	-112.70	-7.50	0.42	48.96	1.24
2200	-18.65	0.12	29.70	18.02	7.96	-83.39	-26.31	0.05	-126.73	-7.36	0.43	30.23	1.24
2400	-18.62	0.12	17.17	17.54	7.53	-103.94	-26.01	0.05	-141.86	-7.23	0.44	11.98	1.24
2600	-18.65	0.12	4.56	17.10	7.16	-124.32	-25.53	0.05	-156.51	-7.15	0.44	-6.20	1.23
2800	-18.75	0.12	-8.50	16.70	6.84	-144.58	-25.04	0.06	-171.83	-7.12	0.44	-24.64	1.22
3000	-18.76	0.12	-21.18	16.34	6.56	-164.74	-24.75	0.06	171.93	-7.05	0.44	-42.66	1.22
3200	-18.96	0.11	-35.61	15.99	6.30	175.07	-24.48	0.06	156.08	-7.09	0.44	-61.20	1.22
3400	-18.90	0.11	-49.02	15.73	6.12	155.00	-24.11	0.06	140.45	-7.08	0.44	-79.49	1.21
3600	-18.89	0.11	-65.42	15.45	5.92	134.61	-23.78	0.06	123.41	-7.04	0.44	-98.54	1.20
3800	-19.03	0.11	-81.50	15.20	5.75	114.46	-23.55	0.07	106.55	-7.07	0.44	-117.58	1.20
4000	-19.18	0.11	-99.15	14.97	5.60	94.17	-23.32	0.07	89.55	-7.09	0.44	-137.39	1.21
4200	-19.27	0.11	-119.97	14.73	5.45	73.59	-23.13	0.07	71.74	-7.05	0.44	-157.69	1.21
4400	-19.34	0.11	-142.24	14.51	5.32	53.03	-23.02	0.07	54.04	-7.00	0.45	-178.52	1.22
4600	-19.13	0.11	-164.39	14.33	5.21	32.18	-22.84	0.07	36.08	-6.90	0.45	160.81	1.22
4800	-18.84	0.11	170.31	14.08	5.06	11.18	-22.74	0.07	17.29	-6.76	0.46	139.32	1.23
5000	-18.86	0.11	146.31	13.90	4.95	-9.54	-22.80	0.07	-1.48	-6.72	0.46	117.81	1.26
5200	-18.20	0.12	120.42	13.68	4.83	-30.82	-22.78	0.07	-20.62	-6.56	0.47	96.00	1.27
5400	-17.65	0.13	93.94	13.44	4.70	-52.28	-22.73	0.07	-39.87	-6.38	0.48	74.14	1.28
5600	-17.20	0.14	67.97	13.21	4.58	-73.69	-22.78	0.07	-59.87	-6.22	0.49	51.89	1.31
6000	-15.66	0.16	19.97	12.67	4.30	-118.38	-23.02	0.07	-100.07	-5.98	0.50	7.93	1.38
6500	-13.89	0.20	-45.20	11.75	3.87	-174.41	-23.26	0.07	-151.71	-5.73	0.52	-49.17	1.52
7000	-11.89	0.25	-108.61	10.48	3.34	129.29	-23.58	0.07	157.79	-5.56	0.53	-106.80	1.74
7500	-10.29	0.31	-165.67	8.76	2.74	73.98	-23.41	0.07	106.68	-5.65	0.52	-162.38	2.01
8000	-8.76	0.36	144.21	6.90	2.21	22.01	-23.07	0.07	54.19	-5.63	0.52	145.92	2.26
8500	-7.90	0.40	96.17	5.00	1.78	-27.88	-22.38	0.08	9.96	-5.74	0.52	96.73	2.52
9000	-7.32	0.43	55.07	3.44	1.49	-74.51	-20.42	0.10	-42.94	-5.70	0.52	53.88	2.33
10000	-7.04	0.44	-28.39	1.01	1.12	-167.06	-16.98	0.14	-134.22	-6.39	0.48	-32.40	2.13

Definitions:

- dB values=20 log (Mag)
- Input Return Loss= -(S11, dB)
- Gain (Power Gain)= (S21, dB)
- Reverse Isolation= -(S12, dB)
- Output Return Loss= -(S22, dB)

Product Marking

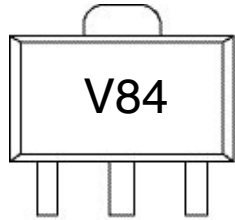

Outline Drawing (SOT-89) DF782

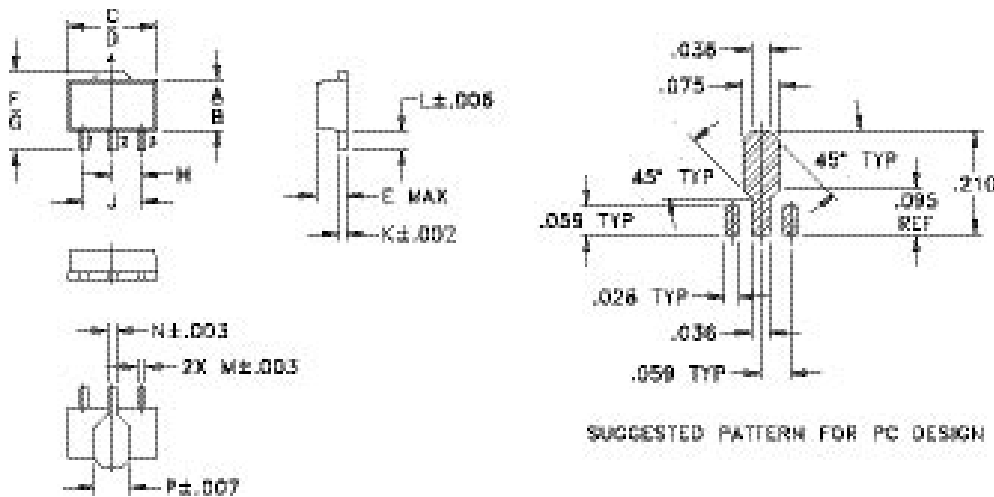

Outline Dimensions (inch mm)

A	B	C	D	E	F	G	H
.102	.090	.181	.173	.063	.167	.155	.059
2.59	2.29	4.60	4.39	1.60	4.24	3.94	1.50
J	K	L	M	N	P	wt	
.118	.015	.041	.016	.019	.065	grams	
3.00	0.38	1.04	0.41	0.48	1.65	0.2	

Suggested Layout for PCB Design (PL-019)

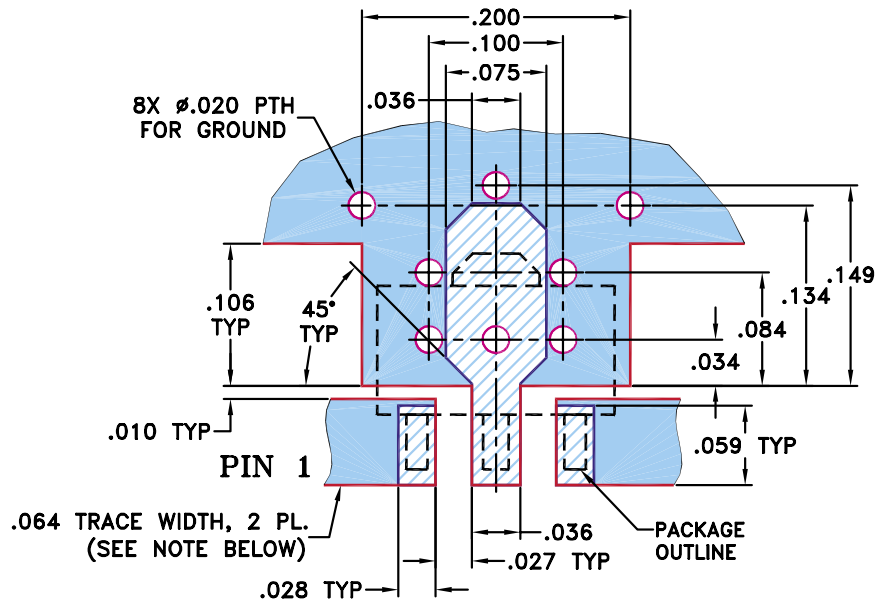

- NOTES:** 1. TRACE WIDTH IS SHOWN FOR ROGERS RO4350B WITH DIELECTRIC THICKNESS .030" ± .002"; COPPER: 1/2 OZ. EACH SIDE.
 FOR OTHER MATERIALS TRACE WIDTH MAY NEED TO BE MODIFIED.
 2. BOTTOM SIDE OF THE PCB IS CONTINUOUS GROUND PLANE.

- DENOTES PCB COPPER LAYOUT WITH SMOBC (SOLDER MASK OVER BARE COPPER)
- DENOTES COPPER LAND PATTERN FREE OF SOLDER MASK

Recommended Application Circuit

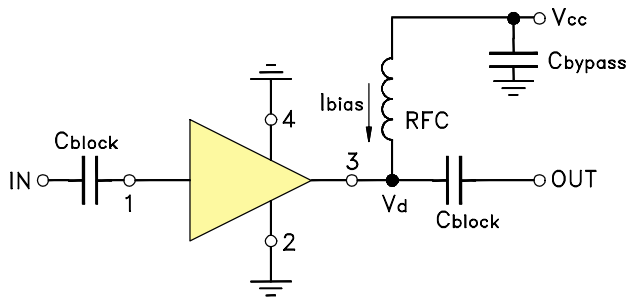

Evaluation Board and Circuit

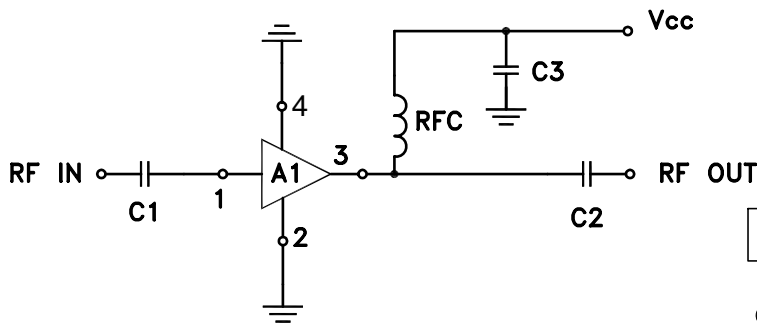

Schematic Diagram

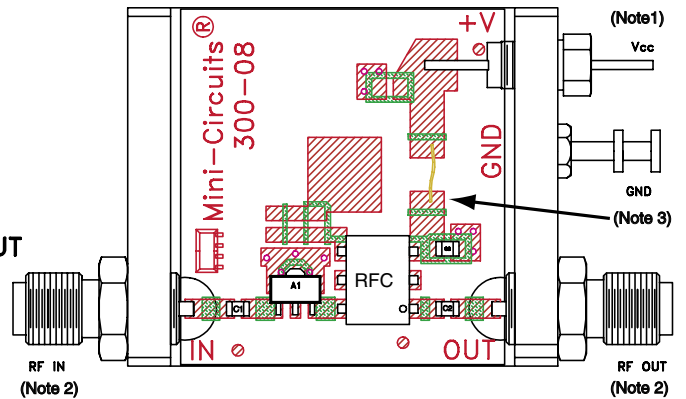

GVA-84TB+

BOM of Evaluation Board

Component	Value	Function
A1	GVA-84+	Device Under Test
C1 (Note 4)	2400 pF	DC Blocking (C block)
C2 (Note 4)	2400 pF	DC Blocking (C block)
C3	0.1 μ F	RF bypass
RFC	Mini-Circuits ADCH-80A	RF choke (50 MHz to 8 GHz)

Notes:

1. Vcc = +5V
2. SMA Female connectors
3. PCB material: Rogers RO4350 or equivalent, dielectric constant=3.5, dielectric thickness= .030 inch.
4. Capacitors, C1&C2 should be free of resonance up to the highest frequency specified.

ESD Rating

Human Body Model (HBM): Class 1C (1000V to < 2,000V) in accordance with ANSI/ESD STM 5.1 - 2001

Machine Model (MM): Class M2 (100V to < 200V) in accordance with ANSI/ESD STM 5.2 - 1999

MSL Rating

Moisture Sensitivity: MSL1 in accordance with IPC/JEDECJ-STD-020C

NO.	TEST REQUIRED	CONDITION	STANDARD	QUANTITY
1	Visual Inspection	Low Power Microscope Magnification 40x	MIP-IN-0003 (MCT spec)	45 units
2	Electrical Test	Room Temperature	SCD (MCL spec)	45 units
3	SAM Analysis	Less than 10% growth in term of delamination	J-Std-020C (Jedec Standard)	45 units
4	Moisture Sensitivity Level 1	Bake at 125°C for 24 hours Soak at 85°C/85%RH for 168 hours Reflow 3 cycles at 260°C peak	J-Std-020C (Jedec Standard)	45 units

MSL Test Flow Chart

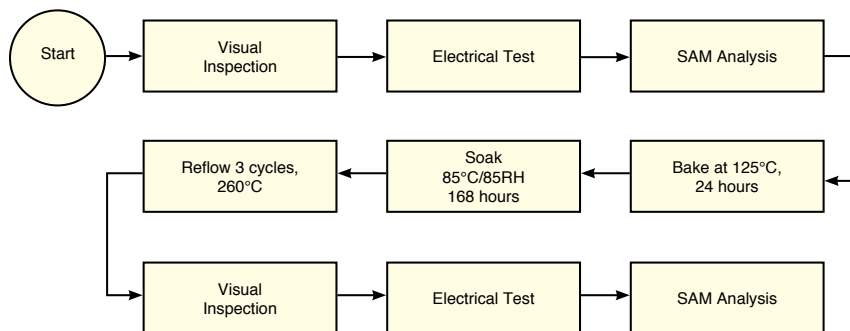

Reliability

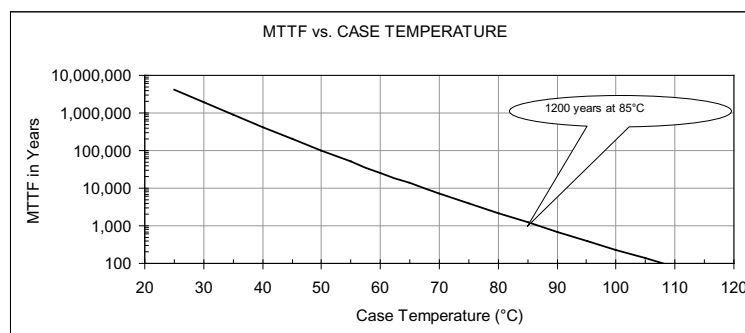

Note: Good heat sink design will reduce case temperature rise above ambient and improve MTTF.

Tape and Reel Packaging Information

Table T&R

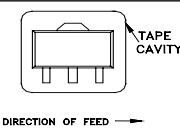
TR No.	No. of Devices	Designation Letter	Reel Size	Tape Width	Pitch	Unit Orientation
T-004	1000	K	7 inch	12mm	8mm	
	multiples of 10, less than full reel of 1K	PR	7 inch			
	multiples of 10, on tape only	E	not applicable			

Ordering Information

Model No.	Description	Packaging Designation Letter (See Table T&R)	Quantity Min. No. of Units	Price, \$ Per Unit	
				Qty. (10)	Qty. (30)
GVA-84+	RoHS Compliant	E	10	3.60	1.82
GVA-84TB+	Evaluation Board with unit mounted	Not Applicable	1	59.95	

How to Order

Example: 1000 pieces of GVA-84+

