

The RF Sub-Micron Bipolar Line RF Power Bipolar Transistor

Designed for broadband commercial and industrial applications at frequencies from 1800 to 2000 MHz. The high gain and broadband performance of this device makes it ideal for large-signal, common-emitter class A and class AB amplifier applications. Suitable for frequency modulated, amplitude modulated and multi-carrier base station RF power amplifiers.

- Specified 26 Volts, 2.0 GHz, Class AB, Two-Tones Characteristics
 - Output Power — 30 Watts (PEP)
 - Power Gain — 9.8 dB
 - Efficiency — 34%
 - Intermodulation Distortion — -28 dBc
- Typical 26 Volts, 1.88 GHz, Class AB, CW Characteristics
 - Output Power — 30 Watts
 - Power Gain — 10.5 dB
 - Efficiency — 40%
- Excellent Thermal Stability
- Capable of Handling 3:1 VSWR @ 26 Vdc, 2000 MHz, 30 Watts (PEP) Output Power
- Characterized with Series Equivalent Large-Signal Impedance Parameters
- S-Parameter Characterization at High Bias Levels
- Designed for FM, TDMA, CDMA, and Multi-Carrier Applications

MRF20030

**30 W, 2.0 GHz
NPN SILICON
BROADBAND
RF POWER TRANSISTOR**

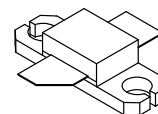

CASE 395D-03, STYLE 1

MAXIMUM RATINGS

Rating	Symbol	Value	Unit
Collector-Emitter Voltage	V _{CEO}	25	Vdc
Collector-Emitter Voltage	V _{CES}	60	Vdc
Collector-Base Voltage	V _{CBO}	60	Vdc
Collector-Emitter Voltage (R _{BE} = 100 Ω)	V _{CER}	30	Vdc
Emitter-Base Voltage	V _{EB}	-3	Vdc
Collector Current - Continuous	I _C	4	Adc
Total Device Dissipation @ T _C = 25°C Derate above 25°C	P _D	125 0.71	Watts W/°C
Storage Temperature Range	T _{stg}	-65 to +150	°C
Operating Junction Temperature	T _J	200	°C

THERMAL CHARACTERISTICS

Rating	Symbol	Max	Unit
Thermal Resistance, Junction to Case (1)	R _{θJC}	1.4	°C/W

(1) Thermal resistance is determined under specified RF operating condition.

ELECTRICAL CHARACTERISTICS (T_C = 25°C unless otherwise noted)

Characteristic	Symbol	Min	Typ	Max	Unit
----------------	--------	-----	-----	-----	------

OFF CHARACTERISTICS

Collector-Emitter Breakdown Voltage (I _C = 25 mAdc, I _B = 0)	V _{(BR)CEO}	25	26	—	Vdc
Collector-Emitter Breakdown Voltage (I _C = 25 mAdc, V _{BE} = 0)	V _{(BR)CES}	60	70	—	Vdc
Collector-Base Breakdown Voltage (I _C = 25 mAdc, I _E = 0)	V _{(BR)CBO}	60	70	—	Vdc

ELECTRICAL CHARACTERISTICS — continued ($T_C = 25^\circ\text{C}$ unless otherwise noted)

Characteristic	Symbol	Min	Typ	Max	Unit
OFF CHARACTERISTICS					
Emitter–Base Breakdown Voltage ($I_B = 5 \text{ mAdc}$, $I_C = 0$)	$V_{(BR)EBO}$	3	3.8	—	Vdc
Collector Cutoff Current ($V_{CE} = 30 \text{ Vdc}$, $V_{BE} = 0$)	I_{CES}	—	—	10	mAdc
ON CHARACTERISTICS					
DC Current Gain ($V_{CE} = 5 \text{ Vdc}$, $I_{CE} = 1 \text{ Adc}$)	h_{FE}	20	40	80	—
DYNAMIC CHARACTERISTICS					
Output Capacitance ($V_{CB} = 26 \text{ Vdc}$, $I_E = 0$, $f = 1.0 \text{ MHz}$) (1)	C_{ob}	—	28	—	pF
FUNCTIONAL TESTS (In Motorola Test Fixture)					
Common–Emitter Amplifier Power Gain ($V_{CC} = 26 \text{ Vdc}$, $P_{out} = 30 \text{ Watts}$, $I_{CQ} = 120 \text{ mA}$, $f_1 = 2000.0 \text{ MHz}$, $f_2 = 2000.1 \text{ MHz}$)	G_{pe}	9.8	10.5	—	dB
Collector Efficiency ($V_{CC} = 26 \text{ Vdc}$, $P_{out} = 30 \text{ Watts (PEP)}$, $I_{CQ} = 120 \text{ mA}$, $f_1 = 2000.0 \text{ MHz}$, $f_2 = 2000.1 \text{ MHz}$)	η	34	38	—	%
Intermodulation Distortion ($V_{CC} = 26 \text{ Vdc}$, $P_{out} = 30 \text{ Watts (PEP)}$, $I_{CQ} = 120 \text{ mA}$, $f_1 = 2000.0 \text{ MHz}$, $f_2 = 2000.1 \text{ MHz}$)	IMD	—	– 33	– 28	dBc
Input Return Loss ($V_{CC} = 26 \text{ Vdc}$, $P_{out} = 30 \text{ Watts (PEP)}$, $I_{CQ} = 125 \text{ mA}$, $f_1 = 2000.0 \text{ MHz}$, $f_2 = 2000.1 \text{ MHz}$)	IRL	10	17	—	dB
Load Mismatch ($V_{CC} = 26 \text{ Vdc}$, $P_{out} = 30 \text{ Watts (PEP)}$, $I_{CQ} = 120 \text{ mA}$, $f_1 = 2000.0 \text{ MHz}$, $f_2 = 2000.1 \text{ MHz}$, Load VSWR = 3:1, All Phase Angles at Frequency of Test)	ψ	No Degradation in Output Power			
Common–Emitter Amplifier Power Gain ($V_{CC} = 26 \text{ Vdc}$, $P_{out} = 30 \text{ Watts (PEP)}$, $I_{CQ} = 125 \text{ mA}$, $f_1 = 1930.0 \text{ MHz}$, $f_2 = 1930.1 \text{ MHz}$)	G_{pe}	—	10.5	—	dB
Collector Efficiency ($V_{CC} = 26 \text{ Vdc}$, $P_{out} = 30 \text{ Watts (PEP)}$, $I_{CQ} = 125 \text{ mA}$, $f_1 = 1930.0 \text{ MHz}$, $f_2 = 1930.1 \text{ MHz}$)	η	—	34	—	%
Intermodulation Distortion ($V_{CC} = 26 \text{ Vdc}$, $P_{out} = 30 \text{ Watts (PEP)}$, $I_{CQ} = 125 \text{ mA}$, $f_1 = 1930.0 \text{ MHz}$, $f_2 = 1930.1 \text{ MHz}$)	IMD	—	– 35	—	dBc
Input Return Loss ($V_{CC} = 26 \text{ Vdc}$, $P_{out} = 30 \text{ Watts (PEP)}$, $I_{CQ} = 125 \text{ mA}$, $f_1 = 1930.0 \text{ MHz}$, $f_2 = 1930.1 \text{ MHz}$)	IRL	—	14	—	dB
GUARANTEED BUT NOT TESTED (In Motorola Test Fixture)					
Common–Emitter Amplifier Power Gain ($V_{CC} = 26 \text{ Vdc}$, $P_{out} = 30 \text{ Watts}$, $I_{CQ} = 125 \text{ mA}$, $f = 1880 \text{ MHz}$)	G_{pe}	—	10.5	—	dB
Collector Efficiency ($V_{CC} = 26 \text{ Vdc}$, $P_{out} = 30 \text{ Watts}$, $I_{CQ} = 125 \text{ mA}$, $f = 1880 \text{ MHz}$)	η	—	40	—	%
Input Return Loss ($V_{CC} = 26 \text{ Vdc}$, $P_{out} = 30 \text{ Watts}$, $I_{CQ} = 125 \text{ mA}$, $f = 1880 \text{ MHz}$)	IRL	—	14	—	dB
Output Mismatch Stress ($V_{CC} = 25 \text{ Vdc}$, $P_{out} = 30 \text{ Watts}$, $I_{CQ} = 125 \text{ mA}$, $f = 1880 \text{ MHz}$, VSWR = 3:1, All Phase Angles at Frequency of Test)	ψ	Typically No Degradation in Output Power			

(1) For Information Only. This Part Is Collector Matched.

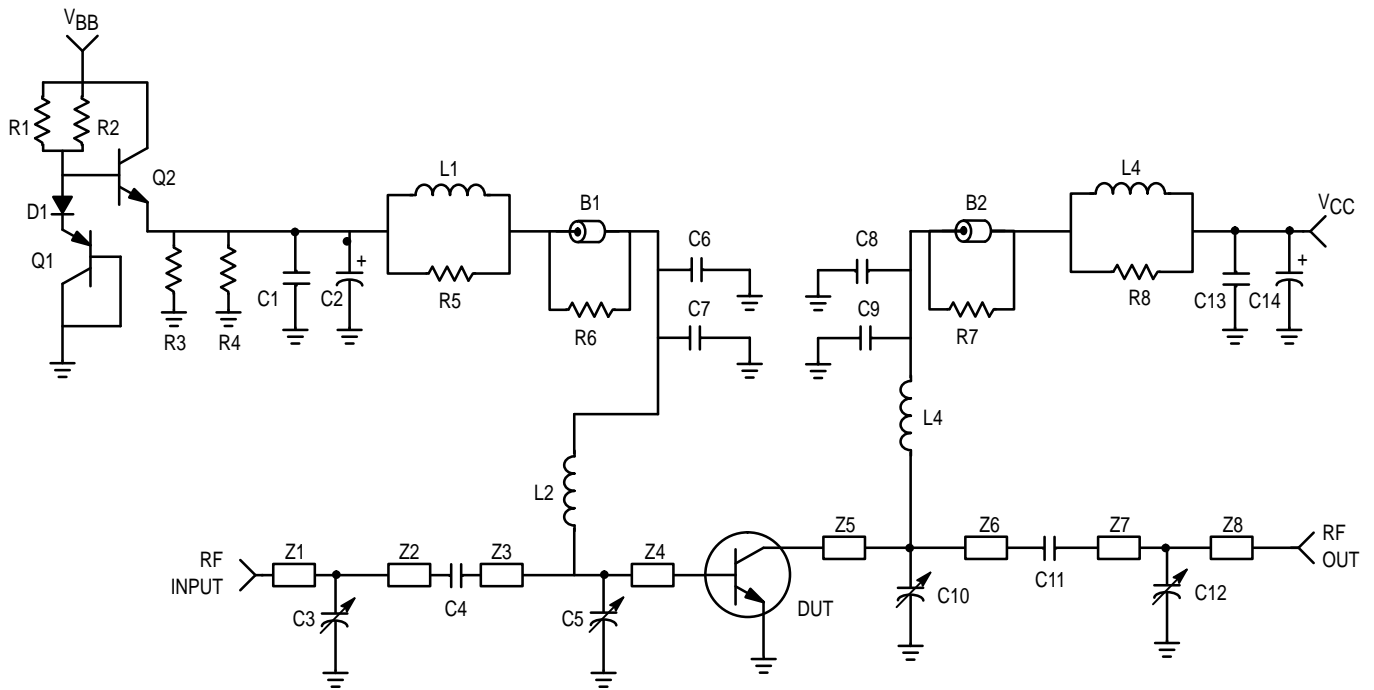

B1, B2	Ferrite Bead, P/N 5659065/3B, Ferroxcube	N1, N2	Type N Flange Mount RF Connector MA/COM 3052-1648-10
C1, C13	0.1 μ F, Chip Capacitor, Kemet	R1, R2	130 Ω , 1/8 W Chip Resistor, Rohm
C2	100 μ F, 50 V, Electrolytic Capacitor, Mallory	R3, R4	100 Ω , 1/8 W Chip Resistor, Rohm
C3, C5, C12	0.6-4 pF, Variable Capacitor, Johanson, Gigatrim	R5, R8	10 Ω , 1/2 W Resistor
C4, C11	10 pF, B Case Chip Capacitor, ATC	R6, R7	10 Ω , 1/8 W Chip Resistor, Rohm (10J)
C6, C8	24 pF, B Case Chip Capacitor, ATC	Q1	Transistor, PNP Motorola (BD136)
C7, C9	75 pF, B Case Chip Capacitor, ATC	Q2	Transistor, NPN Motorola (MJD47)
C10	0.4-2.5 pF, Variable Capacitor, Johanson, Gigatrim	Board	30 Mil Glass Teflon [®] , Arlon GX-0300-55-22, $\epsilon_r = 2.55$
C14	470 μ F, 63 V, Electrolytic Capacitor, Mallory		
D1	Diode, Motorola (MUR3160T3)		
L1, L4	12 Turns, 22 AWG, IDIA. 0.195"		
L2, L3	0.750" 20 AWG		

Figure 1. Class AB Test Fixture Electrical Schematic

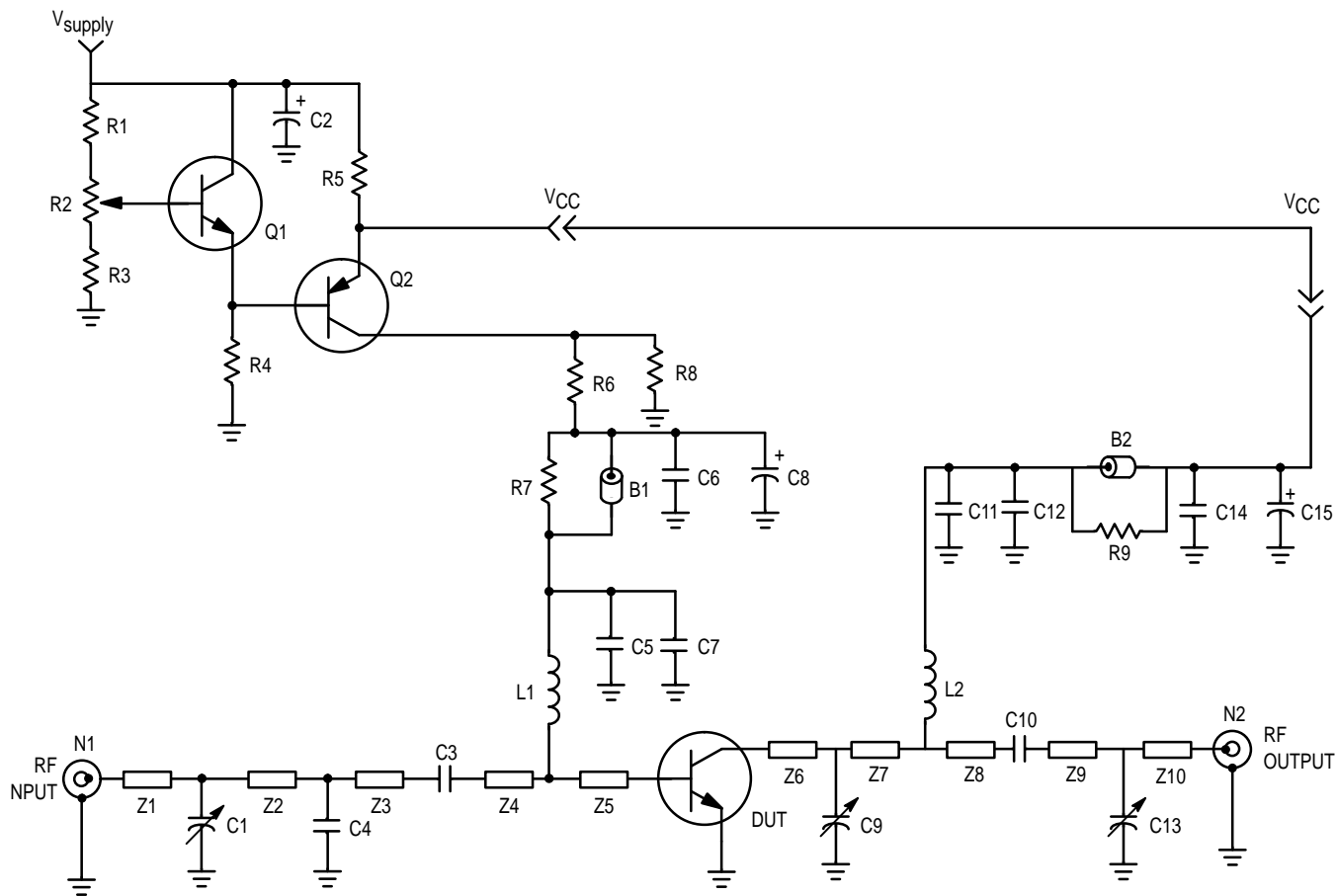

B1, B2	Long Bead, Fair Rite	Q1	Transistor, NPN, Motorola (BD135)
C1, C9, C13	0.6–4 pF, Variable Capacitor, Johanson, Gigatrim	Q2	Transistor, PNP, Motorola (BD136)
C2, C8	100 μ F, 50 V, Electrolytic Capacitor, Mallory	R1	250 Ω , Chip Resistor, 1/8 Watt, Rohm
C3, C10	18 pF B Case Chip Capacitor, ATC	R2	500 Ω , 1/4 Watt, Potentiometer
C4	1.3 pF, B Case Chip Capacitor, ATC	R3	4.7 k Ω , Chip Resistor, 1/8 Watt, Rohm
C5, C11	24 pF, B Case Chip Capacitor, ATC	R4	2 x 4.7 k Ω , Chip Resistor, 1/8 Watt, Rohm
C6, C14	0.1 μ F, Chip Capacitor, Kermet	R5	1.0 Ω , 10 Watt, Resistor, DALE
C7, C12	75 pF, B Case Chip Capacitor, ATC	R6	39 Ω , 1 Watt, Resistor
C15	470 μ F, 63 V, Electrolytic Capacitor, Mallory	R7, R9	4 x 39 Ω , Chip Resistors, 1/8 Watt, Rohm
L1, L2	0.75 in., 20 AWG	R8	75 Ω , Chip Resistor, 1/8 Watt, Rohm
N1, N2	Type N Flange Mount RF Connector, MA/COM	Board	30 Mil Glass Teflon [®] , Arlon GX-0300-55-22, $\epsilon_r = 2.55$

Figure 2. Class A Test Fixture Electrical Schematic

TYPICAL CHARACTERISTICS

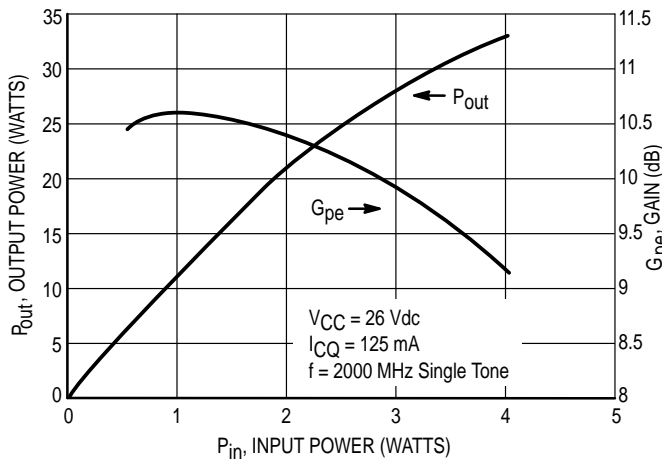

Figure 3. Output Power & Power Gain versus Input Power

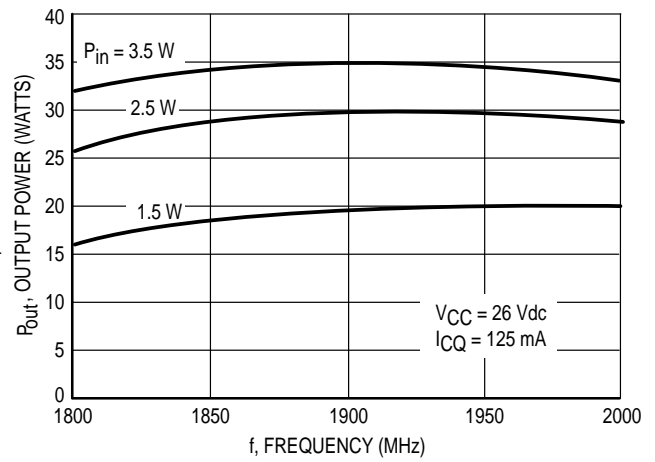

Figure 4. Output Power versus Frequency

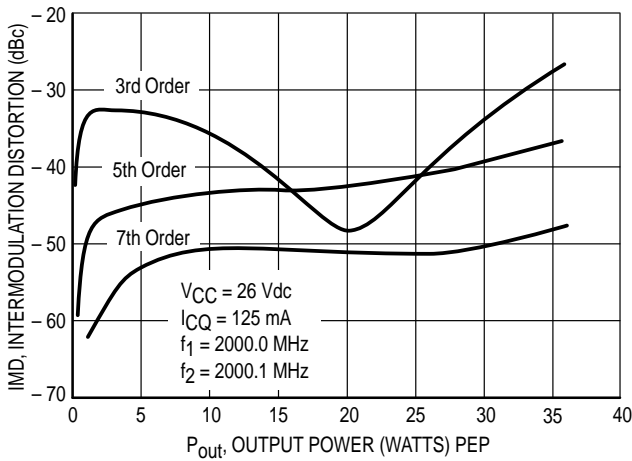

Figure 5. Intermodulation Distortion versus Output Power

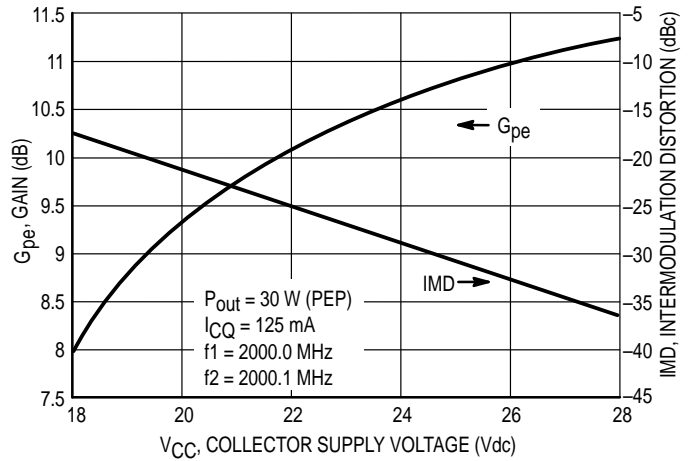

Figure 6. Power Gain and Intermodulation Distortion versus Supply Voltage

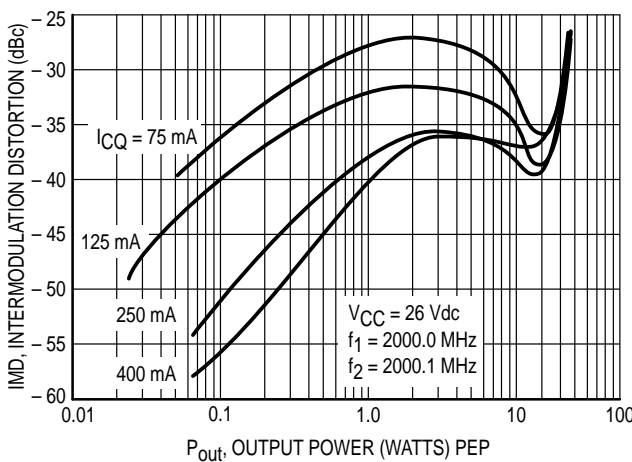

Figure 7. Intermodulation Distortion versus Output Power

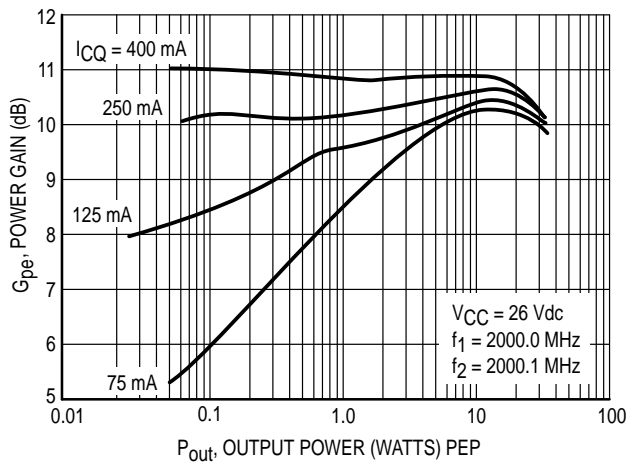

Figure 8. Power Gain versus Output Power

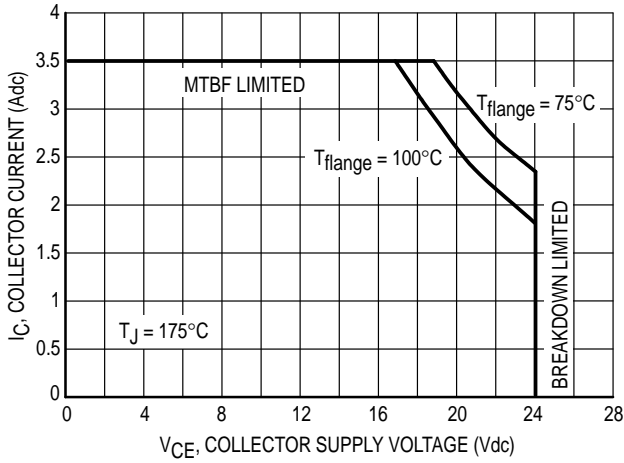

Figure 9. DC Class A Safe Operating Area

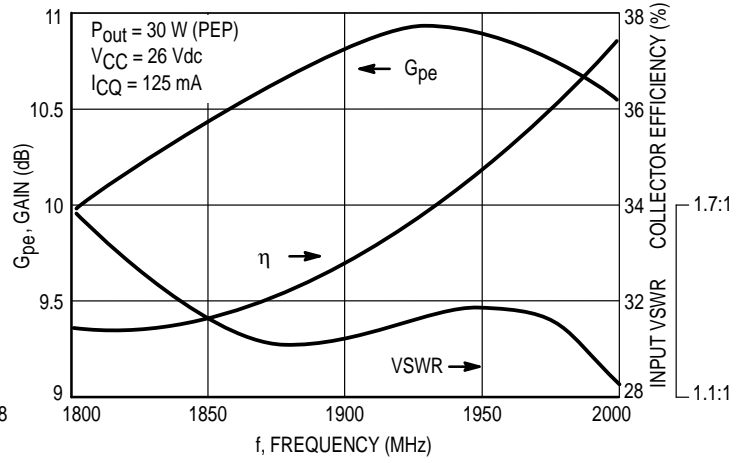

Figure 10. Performance in Broadband Circuit

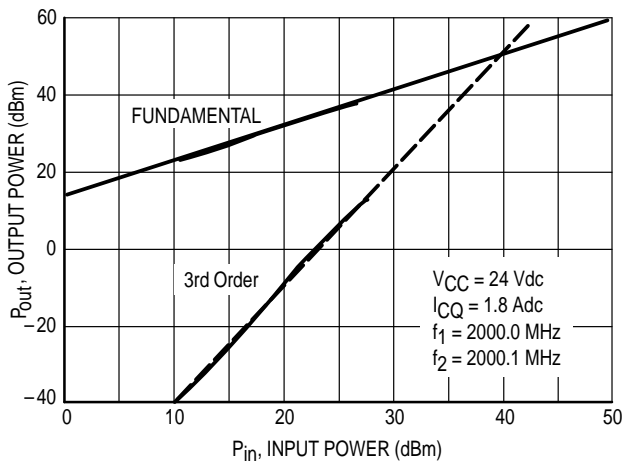
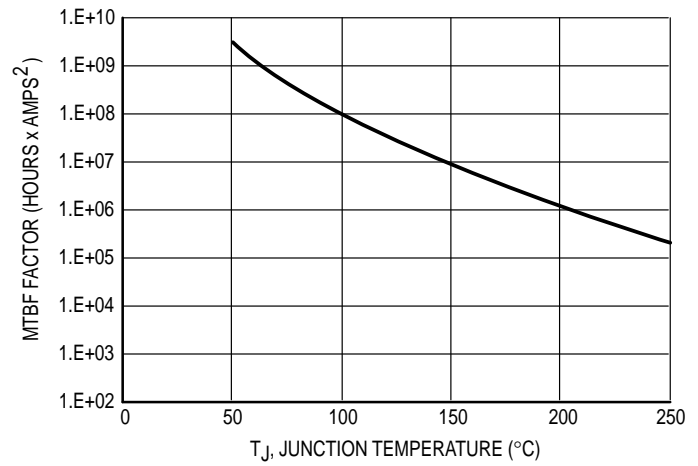
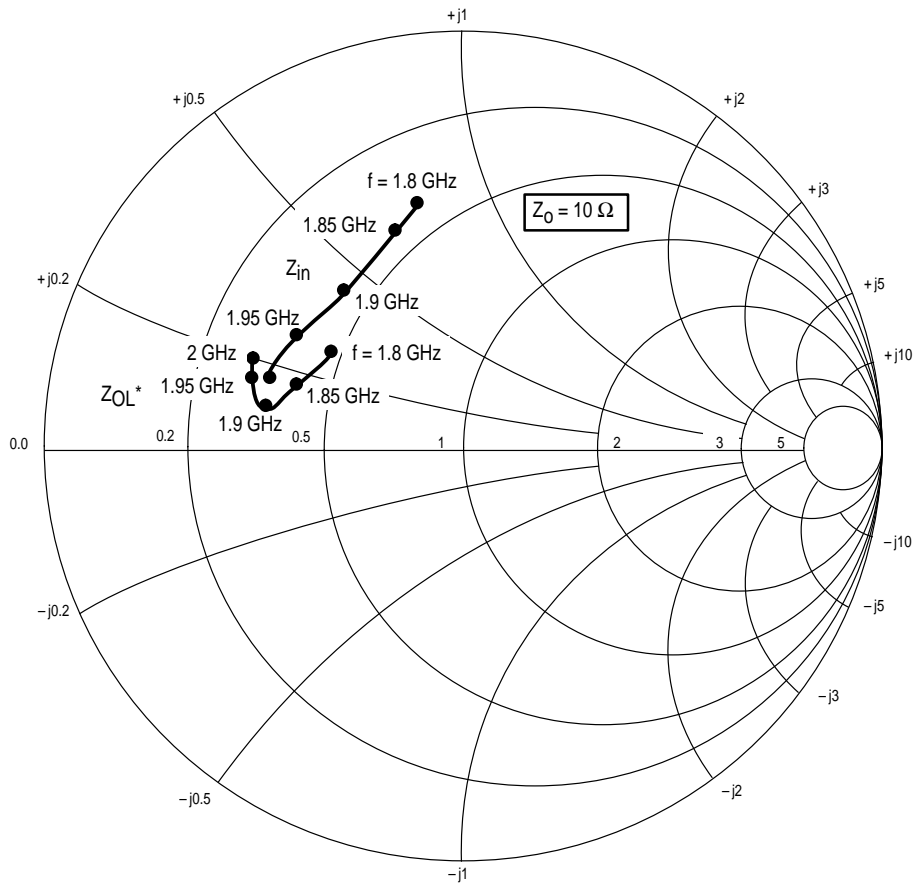

Figure 11. Class A Third Order Intercept Point



This above graph displays calculated MTBF in hours x ampere² emitter current. Life tests at elevated temperatures have correlated to better than $\pm 10\%$ of the theoretical prediction for metal failure. Divide MTBF factor by I_C^2 for MTBF in a particular application.

Figure 12. MTBF Factor versus Junction Temperature



$V_{CC} = 26 \text{ V}$, $I_{CQ} = 125 \text{ mA}$, $P_{out} = 30 \text{ W (PEP)}$

f MHz	$Z_{in}(1)$ Ω	Z_{OL}^* Ω
1800	$4.5 + j7.0$	$4.7 + j2.4$
1850	$4.5 + j6.0$	$4.4 + j1.6$
1900	$4.5 + j4.6$	$3.4 + j1.2$
1950	$3.7 + j2.4$	$3.3 + j1.6$
2000	$3.5 + j1.5$	$3.5 + j2.0$

$Z_{in}(1)$ = Conjugate of fixture base impedance.

Z_{OL}^* = Conjugate of the optimum load impedance at given output power, voltage, bias current and frequency.

Figure 13. Series Equivalent Input and Output Impedance

Table 1. Common Emitter S-Parameters at $V_{CE} = 24$ Vdc, $I_C = 1.8$ Adc

f GHz	S11		S21		S12		S22	
	S11	$\angle \phi$	S21	$\angle \phi$	S12	$\angle \phi$	S22	$\angle \phi$
1.5	.964	158	.65	74	.046	60	.859	161
1.55	.960	156	.74	68	.047	56	.841	161
1.6	.952	155	.87	60	.049	53	.815	160
1.65	.933	153	1.05	50	.048	46	.787	161
1.7	.892	149	1.32	35	.047	40	.744	163
1.75	.804	149	1.64	13	.040	29	.719	168
1.8	.727	157	1.78	-18	.026	21	.778	175
1.85	.787	163	1.50	-50	.015	54	.883	174
1.9	.873	163	1.14	-73	.020	81	.937	171
1.95	.921	160	.84	-89	.026	88	.949	168
2	.941	157	.62	-102	.031	93	.950	165
2.05	.943	155	.48	-109	.036	93	.946	164
2.1	.940	153	.38	-118	.040	92	.942	163
2.15	.928	151	.30	-127	.042	97	.939	162
2.2	.917	150	.24	-133	.049	99	.935	161
2.25	.907	150	.20	-140	.056	101	.933	160
2.3	.888	148	.17	-150	.066	100	.926	159
2.35	.861	148	.14	-159	.077	98	.916	157
2.4	.853	149	.11	-167	.087	92	.909	157
2.45	.860	146	.10	-176	.095	89	.900	155
2.5	.880	146	.10	156	.119	84	.880	155

PACKAGE DIMENSIONS

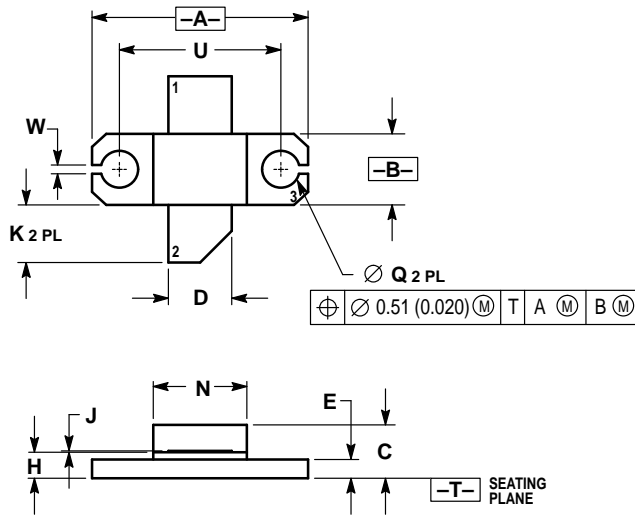

- NOTES:
 1. DIMENSIONING AND TOLERANCING PER ANSI Y14.5M, 1982.
 2. CONTROLLING DIMENSION: INCH.

DIM	INCHES		MILLIMETERS	
	MIN	MAX	MIN	MAX
A	0.739	0.750	18.77	19.05
B	0.240	0.260	6.10	6.60
C	0.165	0.198	4.19	5.03
D	0.215	0.225	5.46	5.72
E	0.060	0.070	1.52	1.78
H	0.084	0.096	2.13	2.44
J	0.004	0.006	0.10	0.15
K	0.178	0.208	4.52	5.28
N	0.315	0.330	8.00	8.38
Q	0.125	0.135	3.18	3.42
U	0.560 BSC		14.23 BSC	
W	0.035	0.045	0.89	1.14

- STYLE 1:
 PIN 1. BASE
 2. COLLECTOR
 3. EMITTER

**CASE 395D-03
 ISSUE B**

Motorola reserves the right to make changes without further notice to any products herein. Motorola makes no warranty, representation or guarantee regarding the suitability of its products for any particular purpose, nor does Motorola assume any liability arising out of the application or use of any product or circuit, and specifically disclaims any and all liability, including without limitation consequential or incidental damages. "Typical" parameters which may be provided in Motorola data sheets and/or specifications can and do vary in different applications and actual performance may vary over time. All operating parameters, including "Typicals" must be validated for each customer application by customer's technical experts. Motorola does not convey any license under its patent rights nor the rights of others. Motorola products are not designed, intended, or authorized for use as components in systems intended for surgical implant into the body, or other applications intended to support or sustain life, or for any other application in which the failure of the Motorola product could create a situation where personal injury or death may occur. Should Buyer purchase or use Motorola products for any such unintended or unauthorized application, Buyer shall indemnify and hold Motorola and its officers, employees, subsidiaries, affiliates, and distributors harmless against all claims, costs, damages, and expenses, and reasonable attorney fees arising out of, directly or indirectly, any claim of personal injury or death associated with such unintended or unauthorized use, even if such claim alleges that Motorola was negligent regarding the design or manufacture of the part. Motorola and  are registered trademarks of Motorola, Inc. Motorola, Inc. is an Equal Opportunity/Affirmative Action Employer.

Mfax is a trademark of Motorola, Inc.

How to reach us:

USA/EUROPE/Locations Not Listed: Motorola Literature Distribution;
P.O. Box 5405, Denver, Colorado 80217. 303-675-2140 or 1-800-441-2447

JAPAN: Nippon Motorola Ltd.: SPD, Strategic Planning Office, 4-32-1,
Nishi-Gotanda, Shinagawa-ku, Tokyo 141, Japan. 81-3-5487-8488

Mfax™: RMFAX0@email.sps.mot.com – TOUCHTONE 602-244-6609
– US & Canada ONLY 1-800-774-1848

ASIA/PACIFIC: Motorola Semiconductors H.K. Ltd.; 8B Tai Ping Industrial Park,
51 Ting Kok Road, Tai Po, N.T., Hong Kong. 852-26629298

INTERNET: <http://motorola.com/sps>



MRF20030/D