



The Future of Analog IC Technology®

MP3213

700KHz/1.3MHz Boost Converter with a 3.5A Switch

DESCRIPTION

The MP3213 is a current mode step-up converter with a 3.5A, 0.18Ω internal switch to provide a highly efficient regulator with fast response. The MP3213 operates at 700KHz or 1.3MHz allowing for easy filtering and low noise. An external compensation pin gives the user flexibility in setting loop dynamics, which allows the use of small, low-ESR ceramic output capacitors. Soft-start results in small inrush current and can be programmed with an external capacitor. The MP3213 operates from an input voltage as low as 2.5V and can generate 12V at up to 500mA from a 5V supply.

The MP3213 includes under-voltage lockout, current limiting and thermal overload protection to prevent damage in the event of an output overload. The MP3213 is available in a low profile 8-pin MSOP package with exposed pad.

EVALUATION BOARD REFERENCE

Board Number	Dimensions
EV3213DH-00A	2.1"X x 2.1"Y x 0.5"Z

FEATURES

- 3.5A, 0.18Ω, 25V Power MOSFET
- Uses Tiny Capacitors and Inductors
- Pin Selectable 700KHz or 1.3MHz Fixed Switching Frequency
- Programmable Soft-Start
- Operates with Input Voltage as Low as 2.5V and Output Voltage as High as 22V
- 12V at 500mA from 5V Input
- UVLO, Thermal Shutdown
- Internal Current Limit
- Available in an 8-Pin MSOP Package with Exposed Pad

APPLICATIONS

- LCD Displays
- Portable Applications
- Handheld Computers and PDAs
- Digital Still and Video Cameras

"MPS" and "The Future of Analog IC Technology" are Registered Trademarks of Monolithic Power Systems, Inc.

TYPICAL APPLICATION

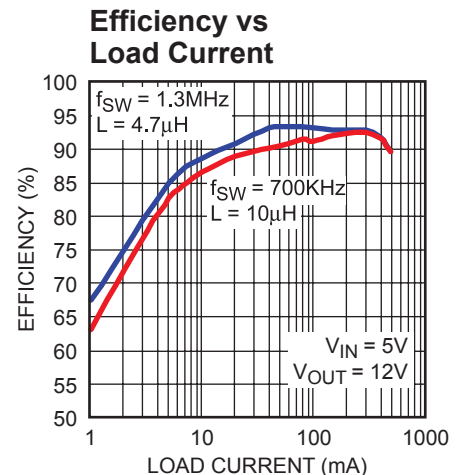
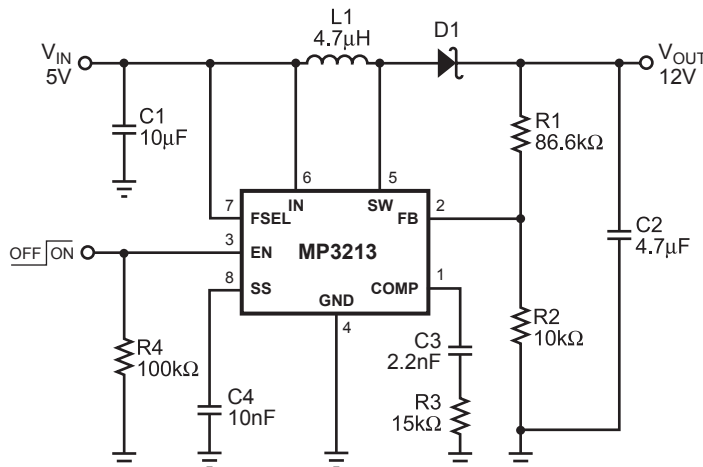

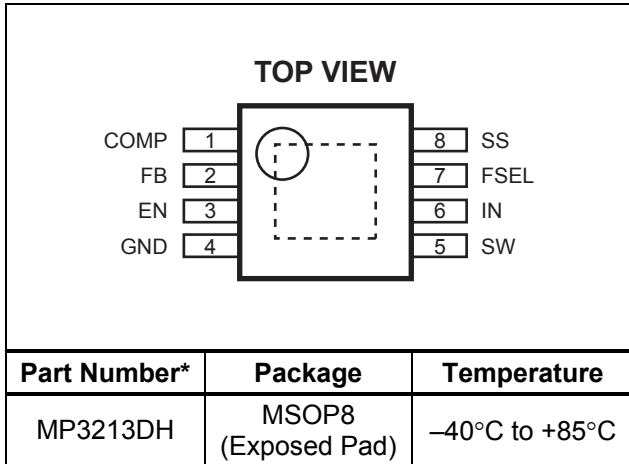
PACKAGE REFERENCE

* For Tape & Reel, add suffix -Z (eg. MP3213DH-Z)
 For RoHS Compliant Packaging, add suffix -LF (eg. MP3213DH-LF-Z)

ABSOLUTE MAXIMUM RATINGS ⁽¹⁾

SW	-0.5V to +25V
IN	-0.5V to +25V
All Other Pins	-0.3V to +6.5V
Junction Temperature	150°C
Lead Temperature	260°C
Storage Temperature	-65°C to +150°C

Recommended Operating Conditions ⁽²⁾

Supply Voltage V_{IN}	2.5V to 22V
Output Voltage V_{OUT}	3V to 22V
Operating Temperature	-40°C to +85°C

Thermal Resistance

	θ_{JA}	θ_{JC}
MSOP8	80	12... °C/W

Notes:

- 1) Exceeding these ratings may damage the device.
- 2) The device is not guaranteed to function outside of its operating conditions.

ELECTRICAL CHARACTERISTICS

$V_{IN} = V_{EN} = 5V$, $T_A = +25^\circ C$, unless otherwise noted.

Parameter	Symbol	Condition	Min	Typ	Max	Units
Operating Input Voltage	V_{IN}		2.5		22	V
Undervoltage Lockout		V_{IN} Rising	2.15		2.45	V
Undervoltage Lockout Hysteresis				100		mV
Supply Current (Shutdown)		$V_{EN} = 0V$		0.1	1	μA
Supply Current (Quiescent)		$V_{FB} = 1.35V$		700	900	μA
Switching Frequency	f_{SW}	$V_{FSEL} = V_{IN}$	1.1	1.3	1.5	MHz
		$V_{FSEL} = GND$	560	700	840	KHz
FSEL High Threshold		V_{FSEL} Rising			1.5	V
FSEL Low Threshold			0.5			V
Maximum Duty Cycle		$V_{FB} = 0V, V_{FSEL} = V_{IN}$	85	90		%
		$V_{FB} = 0V, V_{FSEL} = GND$	92	95		
EN High Threshold		V_{EN} Rising			1.5	V
EN Low Threshold			0.5			V
EN Input Bias Current		$V_{EN} = 0V, 5V$			1	μA
Soft-Start Current				6		μA
FB Voltage			1.225	1.25	1.275	V
FB Input Bias Current			-200	-100		nA
Error Amp Voltage Gain	A_{VEA}			1000		V/V
Error Amp Transconductance	G_{EA}			350		μmho
Error Amp Output Current				35		μA
SW On-Resistance ⁽³⁾	R_{ON}			0.18		Ω
SW Current Limit ⁽³⁾		Duty Cycle = 0%		3.5		A
SW Current Limit ⁽³⁾		Duty Cycle = 50%		2.7		A
SW Leakage		$V_{SW} = 20V$			1	μA
Thermal Shutdown ⁽³⁾				160		$^\circ C$

Note:

3) Guaranteed by design.

TYPICAL PERFORMANCE CHARACTERISTICS

Circuit on front page, $V_{IN} = 5V$, $V_{OUT} = 12V$, $T_A = +25^\circ C$, $C_2 = 4.7\mu F$, $C_4 = 10nF$, unless otherwise noted.

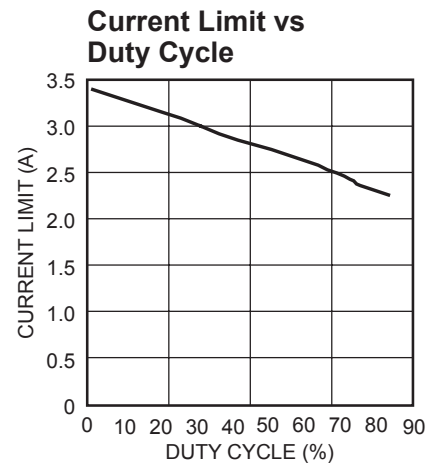
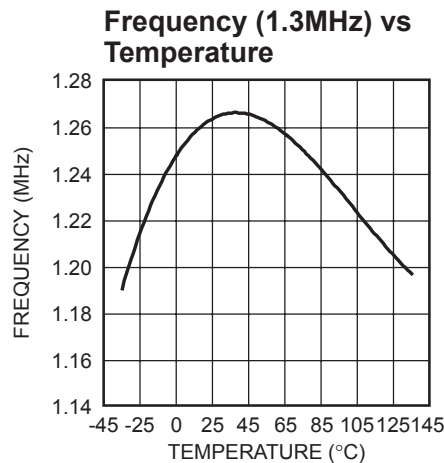
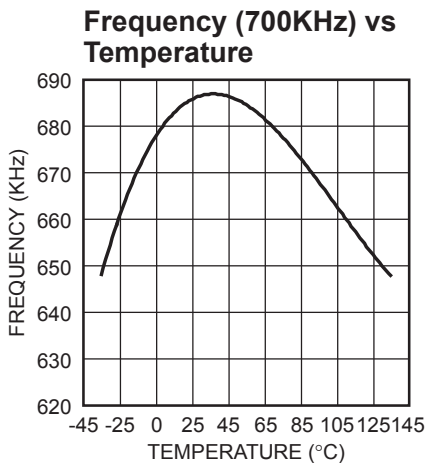
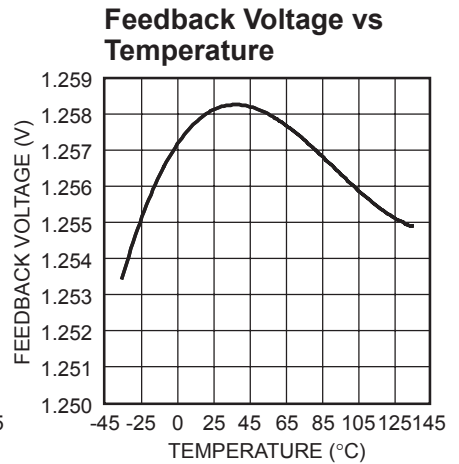
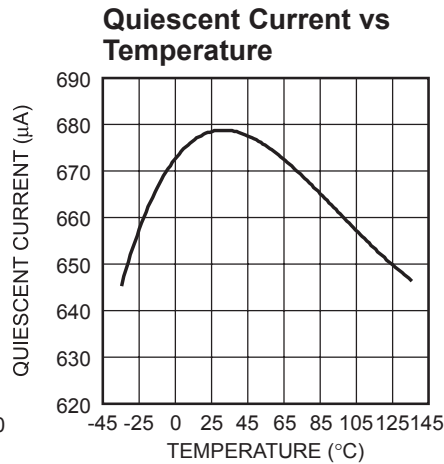
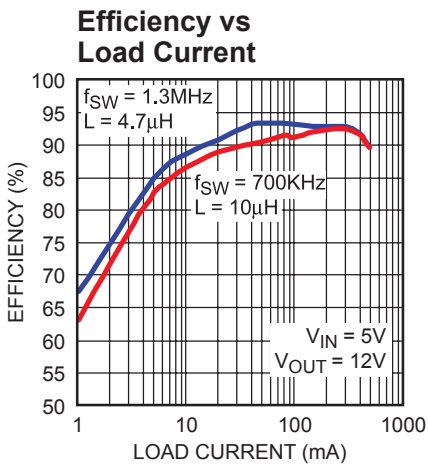
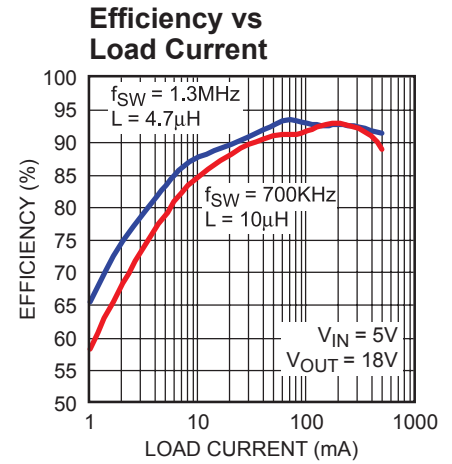
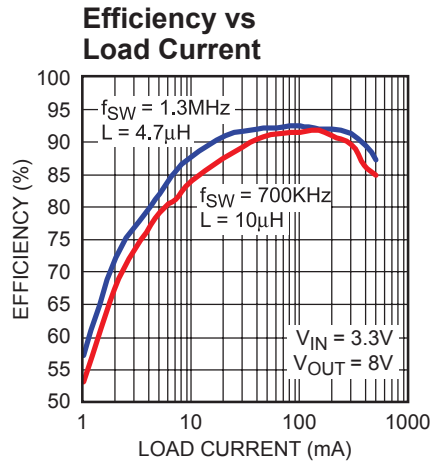
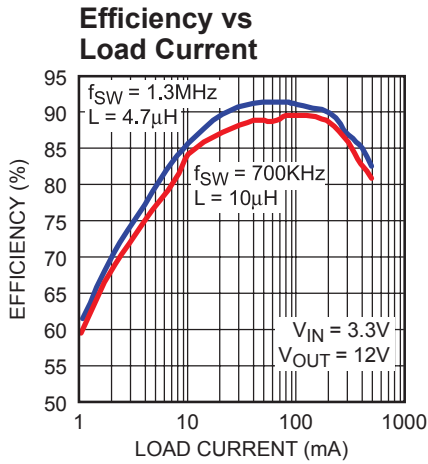

TYPICAL PERFORMANCE CHARACTERISTICS (continued)

Circuit on front page, $V_{IN} = 5V$, $V_{OUT} = 12V$, $T_A = +25^\circ C$, $C_2 = 4.7\mu F$, $C_4 = 10nF$, unless otherwise noted.

Switching Waveform

$I_{LOAD} = 500mA$, $f_{SW} = 1.3MHz$,
 $L = 4.7\mu H$

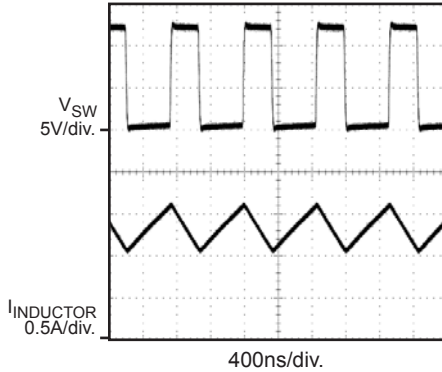
Switching Waveform

$I_{LOAD} = 500mA$, $f_{SW} = 700KHz$,
 $L = 10\mu H$

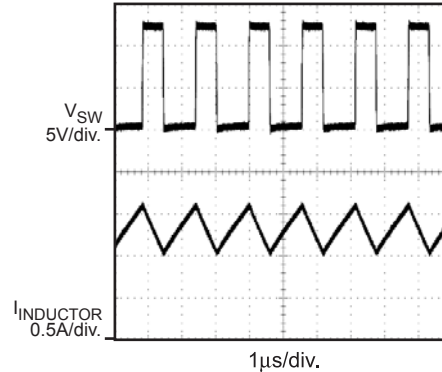
Load Transient Response

$I_{LOAD} = 50mA-500mA$, $f_{SW} = 1.3MHz$,
 $L = 4.7\mu H$

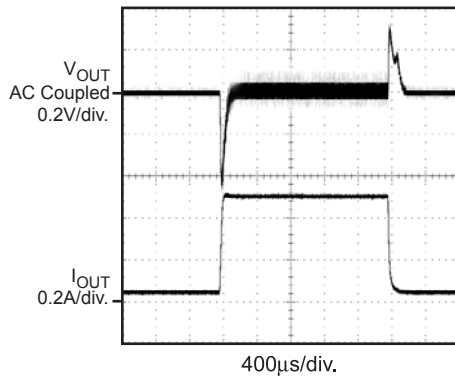
Load Transient Response

$I_{LOAD} = 50mA-500mA$, $f_{SW} = 700KHz$,
 $L = 10\mu H$

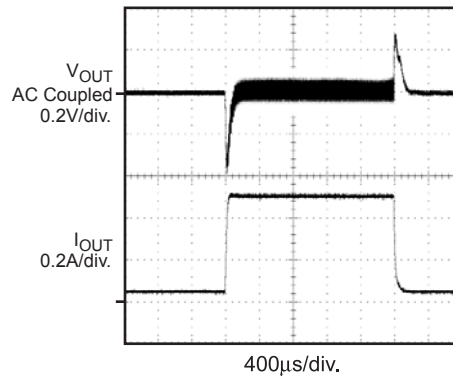
Startup Waveform

$R_{LOAD} = 24\Omega$, $f_{SW} = 1.3MHz$,
 $L = 4.7\mu H$

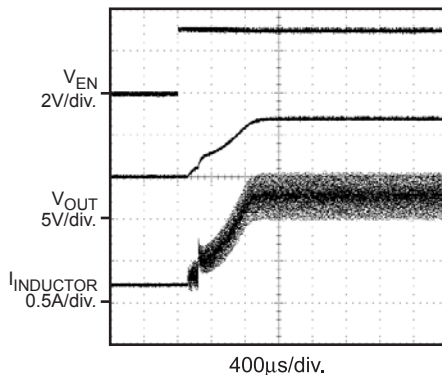
Startup Waveform

$R_{LOAD} = 24\Omega$, $f_{SW} = 700KHz$,
 $L = 10\mu H$

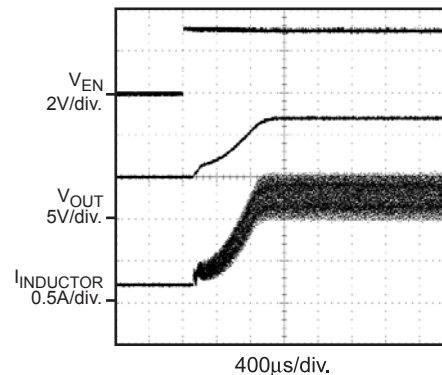

PIN FUNCTIONS

Pin #	Name	Description
1	COMP	Compensation Pin. Connect a capacitor and resistor in series to ground for loop stability.
2	FB	Feedback Input. Reference voltage is 1.25V. Connect a resistor divider to this pin.
3	EN	Regulator On/Off Control Input. A high input at EN turns on the converter, and a low input turns it off. When not used, connect EN to the input source (through a 100kΩ pull-up resistor if $V_{IN} > 6V$) for automatic startup. EN cannot be left floating.
4	GND	Ground. The exposed pad is connected to GND.
5	SW	Power Switch Output. SW is the drain of the internal MOSFET switch. Connect the power inductor and output rectifier to SW. SW can swing between GND and 25V.
6	IN	Input Supply Pin. IN must be locally bypassed.
7	FSEL	Frequency Select Pin. Tie to IN (through a 100kΩ resistor if $V_{IN} > 6V$) for 1.3MHz operation or to GND for 700KHz operation.
8	SS	Soft-Start Control Pin. Connect a soft-start capacitor to this pin. The soft-start capacitor is charged with a constant current of 6μA. Leave SS disconnected if the soft-start is not used.

OPERATION

The MP3213 uses a constant frequency, peak current mode boost regulation architecture to regulate the feedback voltage.

The operation of the MP3213 can be understood by referring to the block diagram of Figure 1.

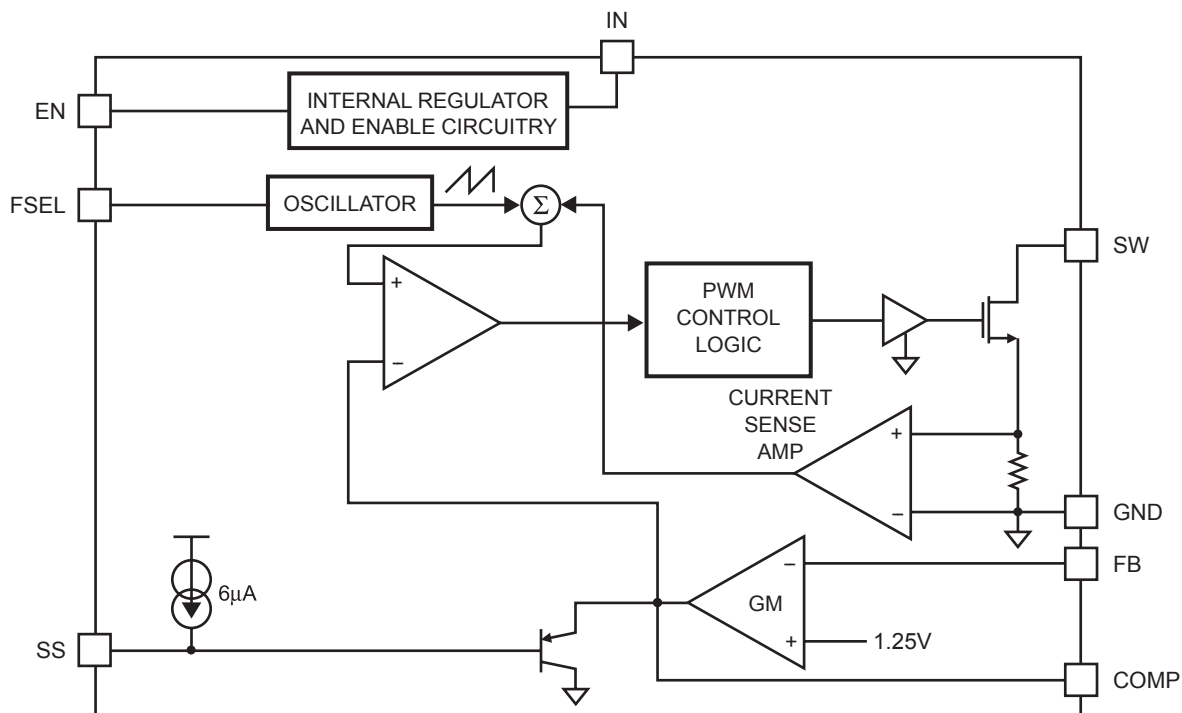

Figure 1—Functional Block Diagram

At the beginning of each cycle, the N-Channel MOSFET switch is turned on, forcing the inductor current to rise. The current at the source of the switch is internally measured and converted to a voltage by the current sense amplifier. That voltage is compared to the error voltage at COMP. The voltage at the output of the error amplifier is an amplified version of the difference between the 1.25V reference voltage and the feedback voltage. When these two voltages are equal, the PWM comparator turns

off the switch forcing the inductor current to the output capacitor through the external rectifier. This causes the inductor current to decrease. The peak inductor current is controlled by the voltage at COMP, which in turn is controlled by the output voltage. Thus the output voltage is regulated by the inductor current to satisfy the load. The use of current mode regulation improves transient response and control loop stability.

APPLICATION INFORMATION

Components referenced below apply to Typical Application Circuit on page 1.

Selecting the Soft-Start Capacitor

The MP3213 includes a soft-start timer that limits the voltage at COMP during startup to prevent excessive current at the input. This prevents fault tripping of the input voltage at startup due to input current overshoot. When power is applied to the MP3213, and enable is asserted, a 6 μ A internal current source charges the external capacitor at SS. As the SS capacitor is charged, the voltage at SS rises. The MP3213 internally clamps the voltage at COMP to 700mV above the voltage at SS. The soft-start ends when the voltage at SS reaches 0.45V. This limits the inductor current at startup, forcing the input current to rise slowly to the current required to regulate the output voltage.

The soft-start period is determined by the equation:

$$t_{SS} = 75 \times C_{SS}$$

Where C_{SS} (in nF) is the soft-start capacitor from SS to GND, and t_{SS} (in μ s) is the soft-start period.

Determine the capacitor required for a given soft-start period by the equation:

$$C_{SS} = 0.0133 \times t_{SS}$$

Setting the Output Voltage

Set the output voltage by selecting the resistive voltage divider ratio. Use 10k Ω for the low-side resistor R2 of the voltage divider. Determine the high-side resistor R1 by the equation:

$$R1 = \frac{R2(V_{OUT} - V_{FB})}{V_{FB}}$$

where V_{OUT} is the output voltage.

For R2 = 10k Ω and V_{FB} = 1.25V, then

$$R1 \text{ (k}\Omega\text{)} = 8\text{k}\Omega (V_{OUT} - 1.25\text{V}).$$

Selecting the Input Capacitor

An input capacitor (C1) is required to supply the AC ripple current to the inductor, while limiting noise at the input source. A low ESR capacitor is required to keep the noise at the IC to a minimum. Ceramic capacitors are preferred, but tantalum or low-ESR electrolytic capacitors may also suffice.

Use an input capacitor value greater than 4.7 μ F. The capacitor can be electrolytic, tantalum or ceramic. However since it absorbs the input switching current it requires an adequate ripple current rating. Use a capacitor with RMS current rating greater than the inductor ripple current (see Selecting The Inductor to determine the inductor ripple current).

To ensure stable operation, place the input capacitor as close to the IC as possible. Alternately a smaller high quality ceramic 0.1 μ F capacitor may be placed closer to the IC with the larger capacitor placed further away. If using this technique, the larger capacitor can be a tantalum or electrolytic type. All ceramic capacitors should be placed close to the MP3213.

Selecting the Output Capacitor

The output capacitor is required to maintain the DC output voltage. Low ESR capacitors are preferred to keep the output voltage ripple to a minimum. The characteristic of the output capacitor also affects the stability of the regulation control system. Ceramic, tantalum, or low ESR electrolytic capacitors are recommended. In the case of ceramic capacitors, the impedance of the capacitor at the switching frequency is dominated by the capacitance, and so the output voltage ripple is mostly independent of the ESR. The output voltage ripple is estimated to be:

$$V_{\text{RIPPLE}} \approx \frac{\left(1 - \frac{V_{\text{IN}}}{V_{\text{OUT}}}\right) \times I_{\text{LOAD}}}{C2 \times f_{\text{SW}}}$$

Where V_{RIPPLE} is the output ripple voltage, V_{IN} and V_{OUT} are the DC input and output voltages respectively, I_{LOAD} is the load current, f_{SW} is the switching frequency, and C2 is the capacitance of the output capacitor.

In the case of tantalum or low-ESR electrolytic capacitors, the ESR dominates the impedance at the switching frequency, and so the output ripple is calculated as:

$$V_{\text{RIPPLE}} \approx \frac{\left(1 - \frac{V_{\text{IN}}}{V_{\text{OUT}}}\right) \times I_{\text{LOAD}}}{C2 \times f_{\text{SW}}} + \frac{I_{\text{LOAD}} \times R_{\text{ESR}} \times V_{\text{OUT}}}{V_{\text{IN}}}$$

Where R_{ESR} is the equivalent series resistance of the output capacitors.

Choose an output capacitor to satisfy the output ripple and load transient requirements of the design. A 4.7 μ F-22 μ F ceramic capacitor is suitable for most applications.

Selecting the Inductor

The inductor is required to force the higher output voltage while being driven by the input voltage. A larger value inductor results in less ripple current that results in lower peak inductor current, reducing stress on the internal N-Channel switch. However, the larger value inductor has a larger physical size, higher series resistance, and/or lower saturation current.

A 4.7 μ H inductor is recommended for most 1.3MHz applications and a 10 μ H inductor is recommended for most 700KHz applications. However, a more exact inductance value can be calculated. A good rule of thumb is to allow the peak-to-peak ripple current to be approximately 30-50% of the maximum input current. Make sure that the peak inductor current is below 75% of the current limit at the operating duty cycle to prevent loss of regulation due to the current limit. Also make sure that the inductor does not saturate under the worst-case load transient and startup conditions. Calculate the required inductance value by the equation:

$$L = \frac{V_{\text{IN}} \times (V_{\text{OUT}} - V_{\text{IN}})}{V_{\text{OUT}} \times f_{\text{SW}} \times \Delta I}$$

$$I_{\text{IN(MAX)}} = \frac{V_{\text{OUT}} \times I_{\text{LOAD(MAX)}}}{V_{\text{IN}} \times \eta}$$

$$\Delta I = (30\% - 50\%) I_{\text{IN(MAX)}}$$

Where $I_{\text{LOAD(MAX)}}$ is the maximum load current, ΔI is the peak-to-peak inductor ripple current, and η is efficiency.

Selecting the Diode

The output rectifier diode supplies current to the inductor when the internal MOSFET is off. To reduce losses due to diode forward voltage and recovery time, use a Schottky diode with the MP3213. The diode should be rated for a reverse voltage equal to or greater than the output voltage used. The average current rating must be greater than the maximum load current expected, and the peak current rating must be greater than the peak inductor current.

Compensation

The output of the transconductance error amplifier (COMP) is used to compensate the regulation control system. The system uses two poles and one zero to stabilize the control loop. The poles are f_{P1} set by the output capacitor C2 and load resistance and f_{P2} set by the compensation capacitor C3. The zero f_{Z1} is set by the compensation capacitor C3 and the compensation resistor R3. These are determined by the equations:

$$f_{P1} = \frac{1}{\pi \times C2 \times R_{LOAD}}$$

$$f_{P2} = \frac{G_{EA}}{2 \times \pi \times C3 \times A_{VEA}}$$

$$f_{Z1} = \frac{1}{2 \times \pi \times C3 \times R3}$$

Where R_{LOAD} is the load resistance, G_{EA} is the error amplifier transconductance, and A_{VEA} is the error amplifier voltage gain.

The DC loop gain is:

$$A_{VDC} = \frac{1.5 \times A_{VEA} \times V_{IN} \times R_{LOAD} \times V_{FB}}{V_{OUT}^2}$$

Where V_{FB} is the feedback regulation threshold.

There is also a right-half-plane zero (f_{RHPZ}) that exists in continuous conduction mode (inductor current does not drop to zero on each cycle) step-up converters. The frequency of the right half plane zero is:

$$f_{RHPZ} = \frac{V_{IN}^2 \times R_{LOAD}}{2 \times \pi \times L \times V_{OUT}^2}$$

Table 1 lists generally recommended compensation components for different input voltage, output voltage and capacitance of most frequently used output ceramic capacitors. Ceramic capacitors have extremely low ESR, therefore the second compensation capacitor (from COMP to GND) is not required.

Table 1—Component Selection

V _{IN} (V)	V _{OUT} (V)	C2 (µF)	R3 (kΩ)	C3 (nF)
3.3	8	4.7	10	2.2
3.3	8	10	10	2.2
3.3	8	22	10	2.2
3.3	12	4.7	15	1
3.3	12	10	15	1
3.3	12	22	15	2.2
3.3	18	4.7	20	1
3.3	18	10	20	1
3.3	18	22	30	2.2
5	8	4.7	10	4.7
5	8	10	10	4.7
5	8	22	15	1
5	12	4.7	15	2.2
5	12	10	15	2.2
5	12	22	20	1
5	18	4.7	20	1
5	18	10	20	1
5	18	22	30	1
12	15	4.7	10	2.2
12	15	10	10	2.2
12	15	22	15	1
12	18	4.7	5.1	2.2
12	18	10	5.1	2.2
12	18	22	15	1

For faster control loop and better transient response, set the capacitor C3 to the recommended value in Table 1. Then slowly increase the resistor R3 and check the load step response on a bench to make sure the ringing and overshoot on the output voltage at the edge of the load steps is minimal. Finally, the compensation needs to be checked by calculating the DC loop gain and the crossover frequency. The crossover frequency where the loop gain drops to 0dB or a gain of 1 can be obtained visually by placing a -20dB/decade slope at each pole, and a $+20\text{dB/decade}$ slope at each zero. The crossover frequency should be at least one decade below the frequency of the right-half-plane zero at maximum output load current to obtain high enough phase margin for stability.

Layout Consideration

High frequency switching regulators require very careful layout for stable operation and low noise. All components must be placed as close to the IC as possible. Keep the path between the SW pin, output diode, output capacitor and GND pin extremely short for minimal noise and ringing. The input capacitor must be placed close to the IN pin for best decoupling. All feedback components must be kept close to the FB pin to prevent noise injection on the FB pin trace. The ground return of the input and output capacitors should be tied close to the GND pin. See the MP3213 demo board layout for reference.

TYPICAL APPLICATION CIRCUIT

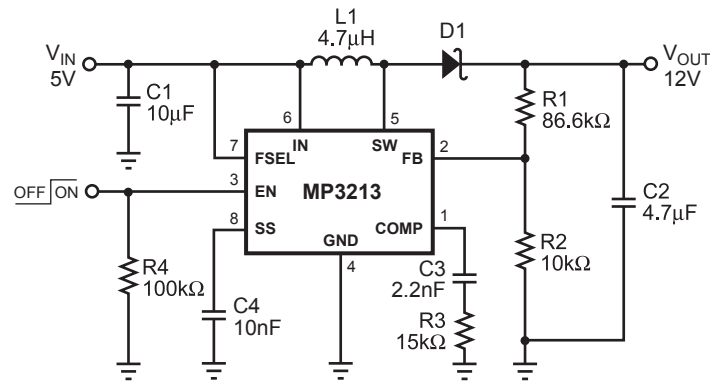
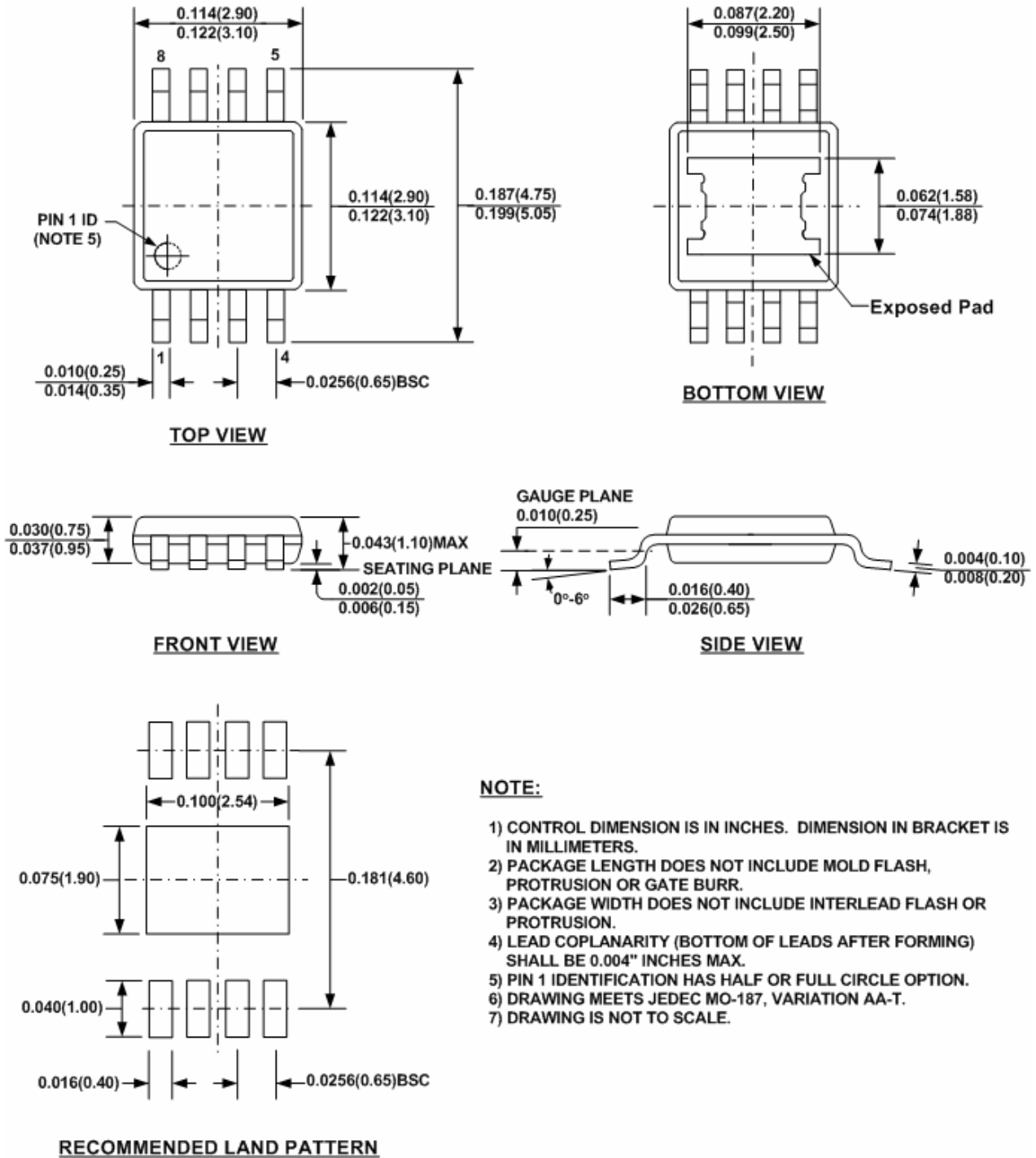

Figure 2—Typical Application Circuit

PACKAGE INFORMATION

MSOP8



NOTICE: The information in this document is subject to change without notice. Please contact MPS for current specifications. Users should warrant and guarantee that third party Intellectual Property rights are not infringed upon when integrating MPS products into any application. MPS will not assume any legal responsibility for any said applications.