



Features

- Lead free as standard
- RoHS compliant*
- Low profile
- Low power loss, high efficiency
- UL 94V-0 classification

Applications

- High frequency switching power supplies
- Inverters
- Free wheeling
- Polarity protection

CD2010-B140 – Surface Mount Schottky Rectifier Diode

General Information

The markets of portable communications, computing and video equipment are challenging the semiconductor industry to develop increasingly smaller electronic components. Bourns offers Schottky Rectifier Diodes for rectification applications, in compact chip package 2010 size format, which offers PCB real estate savings and are considerably smaller than most competitive parts. The Schottky Rectifier Diodes offer a forward current of 1 A with a repetitive peak reverse voltage of 40 V.

Bourns® Chip Diodes conform to JEDEC standards, are easy to handle on standard pick and place equipment and their flat configuration minimizes roll away.

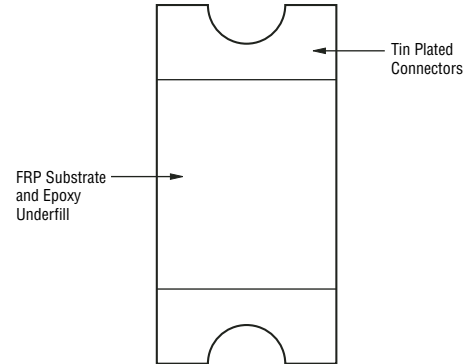

Electrical Characteristics (@ $T_A = 25\text{ }^\circ\text{C}$ Unless Otherwise Noted)

Parameter	Symbol	Min.	Nom.	Max.	Unit
DC Blocking Voltage	V_{DC}			40	V
Repetitive Peak Reverse Voltage	V_{RRM}			40	V
Average Forward Rectified Current ¹	$I_{(AV)}$			1.0	A
Instantaneous Forward Voltage @ $I_F = 1.0\text{ A}$	V_F		0.45	0.55	V
Reverse Leakage Current @ V_{RRM}	I_R			0.1	mA
Peak forward surge current 8.3 ms single half sine-wave superimposed on rated load (JEDEC Method)	I_{FSM}			70	A

Notes:

1 See Forward Derating Curve.

Thermal Characteristics (@ $T_A = 25\text{ }^\circ\text{C}$ Unless Otherwise Noted)

Parameter	Symbol	Min.	Nom.	Max.	Unit
Junction Temperature Range	T_J	-40	+25	+125	$^\circ\text{C}$
Storage Temperature Range	T_{STG}	-40	+25	+125	$^\circ\text{C}$

CD2010-B140 – Surface Mount Schottky Rectifier Diode

BOURNS®

Product Dimensions

This is a lead free product. It is packaged with FRP substrate and is epoxy underfilled. The terminals are pure tin plated and are solderable per MIL-STD-750, Method 2026. The package weighs approximately 0.02 g. The package and dimensions are shown below.

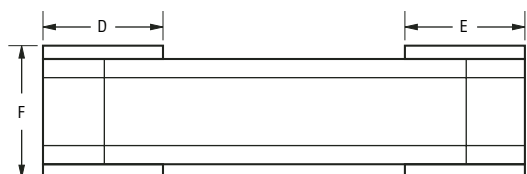
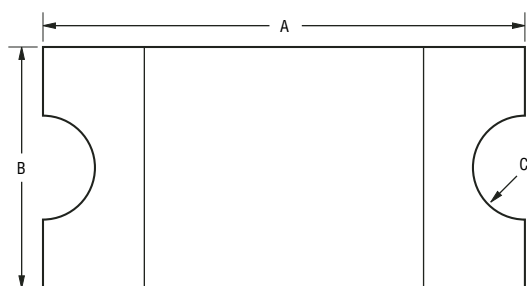

Dimensions	
A	$\frac{4.40 - 4.60}{(0.173 - 0.181)}$
B	$\frac{2.10 - 2.30}{(0.083 - 0.091)}$
C	$\frac{0.50}{(0.020)}$
D	$\frac{0.75 - 1.15}{(0.029 - 0.045)}$
E	$\frac{0.75 - 1.15}{(0.029 - 0.045)}$
F	$\frac{0.85 - 1.25}{(0.033 - 0.049)}$

DIMENSIONS: $\frac{\text{MM}}{\text{(INCHES)}}$

Recommended Footprint

The device will mount onto existing JEDEC SOD-106 footprint.

How To Order

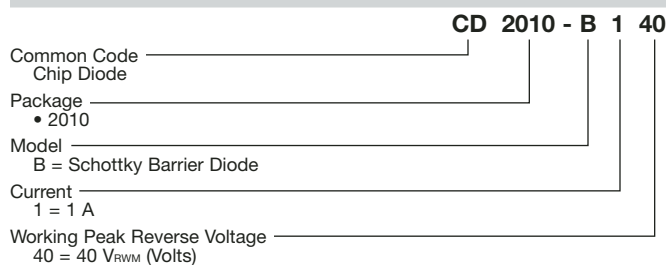

CD2010-B140 – Surface Mount Schottky Rectifier Diode



Rating and Characteristic Curves

Forward Current Derating Curve

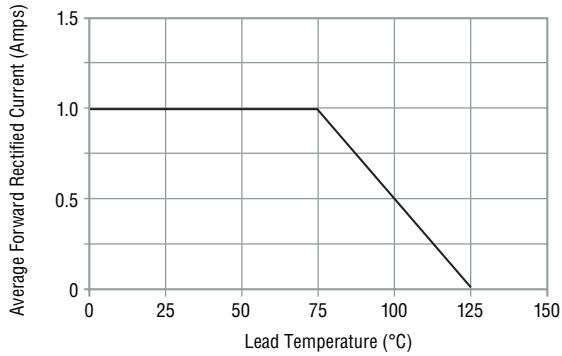

Maximum Non-Repetitive Peak Forward Surge Current

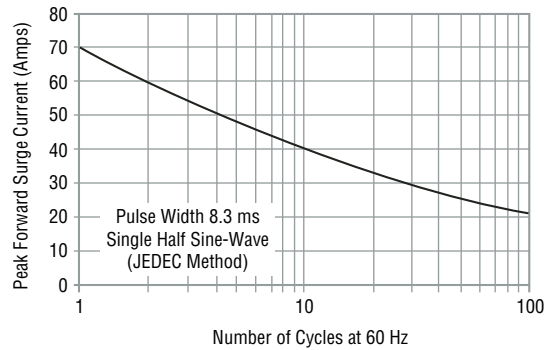

Forward Characteristics

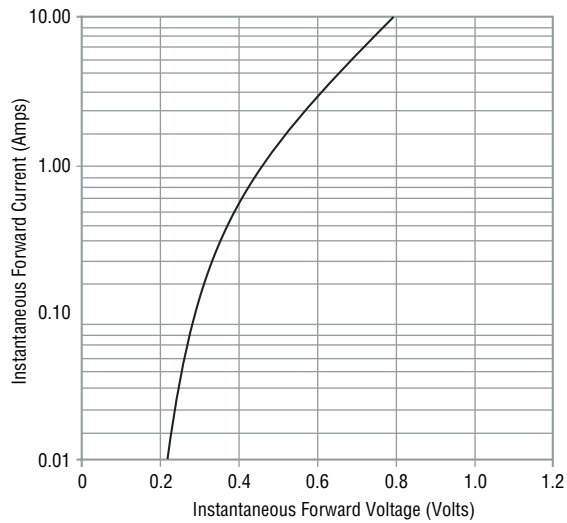

Reverse Characteristics

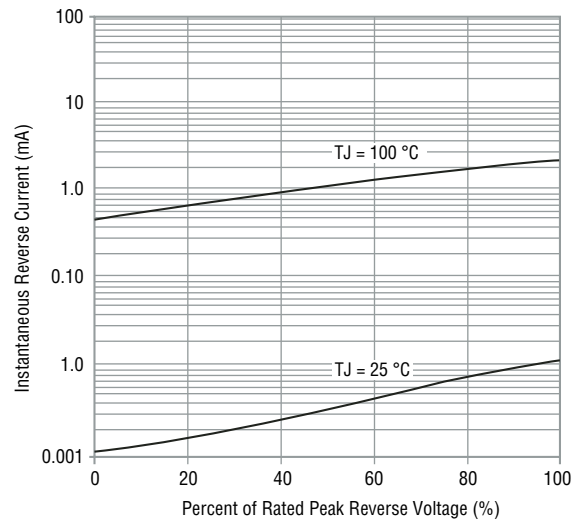

Typical Junction Capacitance

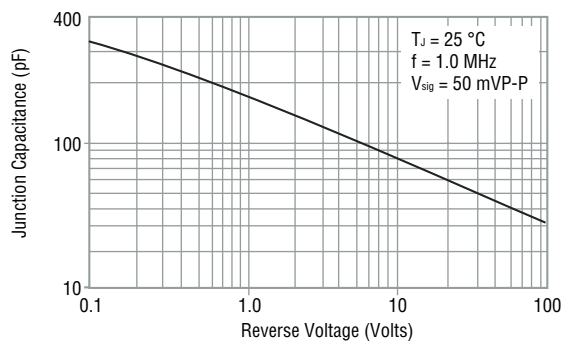

*RoHS Directive 2002/95/EC Jan 27 2003 including Annex
 Specifications are subject to change without notice.
 Customers should verify actual device performance in their specific applications.

CD2010-B140 – Surface Mount Schottky Rectifier Diode

BOURNS®

Packaging Information

The product will be dispensed in Tape and Reel format (see diagram below).

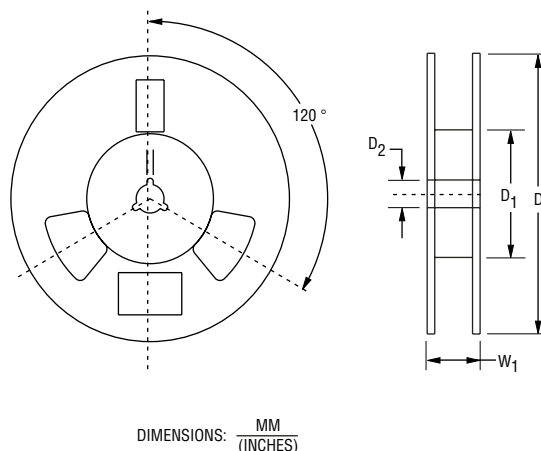
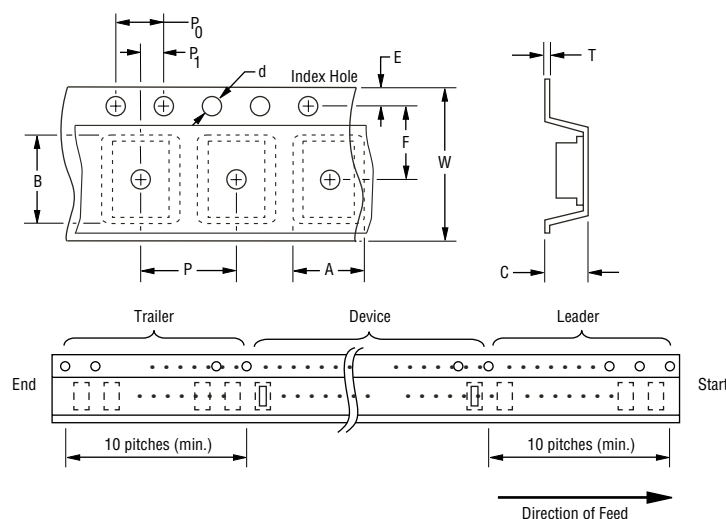

Devices are packed in accordance with EIA standard RS-481-A and specifications shown here.

Item	Symbol	2010
Carrier Width	A	$\frac{2.80 \pm 0.10}{(0.110 \pm 0.004)}$
Carrier Length	B	$\frac{5.00 \pm 0.10}{(0.197 \pm 0.004)}$
Carrier Depth	C	$\frac{1.55 \pm 0.10}{(0.061 \pm 0.004)}$
Sprocket Hole	d	$\frac{1.55 \pm 0.05}{(0.061 \pm 0.002)}$
Reel Outside Diameter	D	$\frac{178}{(7.008)}$
Reel Inner Diameter	D ₁	$\frac{80.0}{(3.150)}$ Min.
Feed Hole Diameter	D ₂	$\frac{13.0 \pm 0.20}{(0.512 \pm 0.008)}$
Sprocket Hole Position	E	$\frac{1.75 \pm 0.10}{(0.069 \pm 0.004)}$
Punch Hole Position	F	$\frac{3.50 \pm 0.05}{(0.138 \pm 0.002)}$
Punch Hole Pitch	P	$\frac{4.00 \pm 0.10}{(0.157 \pm 0.004)}$
Sprocket Hole Pitch	P ₀	$\frac{4.00 \pm 0.10}{(0.157 \pm 0.004)}$
Embossment Center	P ₁	$\frac{2.00 \pm 0.05}{(0.079 \pm 0.002)}$
Overall Tape Thickness	T	$\frac{0.20 \pm 0.10}{(0.008 \pm 0.004)}$
Tape Width	W	$\frac{8.00 \pm 0.20}{(0.315 \pm 0.008)}$
Reel Width	W ₁	$\frac{13.5}{(0.531)}$ Max.
Quantity per Reel	—	2,500



Reliable Electronic Solutions

Asia-Pacific:

Tel: +886-2 2562-4117 • Fax: +886-2 2562-4116

Europe:

Tel: +41-41 768 5555 • Fax: +41-41 768 5510

The Americas:

Tel: +1-951 781-5500 • Fax: +1-951 781-5700

www.bourns.com

*RoHS Directive 2002/95/EC Jan 27 2003 including Annex Specifications are subject to change without notice. Customers should verify actual device performance in their specific applications.