

T-46-B-25

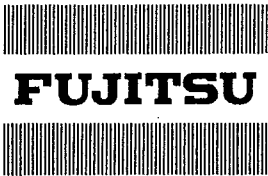

**PROGRAMMABLE
SCHOTTKY 4096-BIT
READ-ONLY MEMORY**

**MB 7123E/H
MB 7124E/H/Y
MB 7123L
MB 7124L**

June 1987
Edition 3.0



SCHOTTKY 4096-BIT DEAP PROM (512 WORDS X 8 BITS)

The Fujitsu MB 7123 and MB 7124 are high speed Schottky TTL electrically field programmable read only memories organized as 512 words by 8 bits. With uncommitted collector outputs provided on the MB 7123 and three-state outputs on the MB 7124, memory expansion is simple.

The memory is fabricated with all logic "zeros" (positive logic). Logic level "ones" can be programmed by the highly reliable DEAP (Diffused Eutectic Aluminum Process) according to simple programming procedures.

The sophisticated passive isolation termed IOP (Isolation by Oxide and Poly-silicon) with thin epitaxial layer and Schottky TTL process permits minimal chip size and fast access time.

The extra test cells and unique testing methods provide enhanced correlation between programmed and unprogrammed circuits in order to perform AC, DC and programming test prior to shipment. This results in extremely high programmability.

- Single +5V supply voltage.
- 512 words x 8 bits organization, fully decoded.
- Proven high programmability and reliability.
- Programming by DEAP (diffused Eutectic Aluminum process).
- Simplified and lower power programming.
- Low current PNP inputs.
- AC characteristics guaranteed over full operating voltage and temperature range via unique testing techniques.
- Fast access time, 25ns typ
Y: 30ns max. H: 35ns max.
E: 45ns max.
- Fast access time, 35 ns typ.
L: 60 ns max.
- TTL compatible inputs and outputs.
- Open collector outputs (MB 7123)
- 3-state outputs (MB 7124)
- One chip enable leads for simplified memory expansion.
- Standard 20 pin Ceramic (Cer-dip) DIP (Suffix: -Z)
- Standard 20 pin Plastic DIP (Suffix: -P)
- Standard 20 pin Plastic FPT (Suffix: -PF)
- Standard 20 pad Ceramic LCC (Suffix: -TV)
- JEDEC approved pin out.

ABSOLUTE MAXIMUM RATINGS (See NOTE)

| Rating | Symbol | Value | Unit |
|---|------------------|-------------------------|------|
| Power Supply Voltage | V _{CC} | -0.5 to +7.0 | V |
| Power Supply Voltage (during programming) | V _{CCP} | -0.5 to +7.5 | V |
| Input Voltage | V _{IN} | -1.5 to +5.5 | V |
| Input Voltage (during programming) | V _{PRG} | 22.5 | V |
| Output Voltage (during programming) | V _{PRG} | -0.5 to +22.5 | V |
| Input Current | I _{IN} | -20 | mA |
| Input Current (during programming) | I _{PRG} | +270 | mA |
| Output Current | I _{OUT} | +100 | mA |
| Output Current (during programming) | I _{PRG} | +150 | mA |
| Storage Temperature | Ceramic | -65 to +150 | °C |
| | Plastic | -40 to +125 | |
| Output Voltage | V _{OUT} | -0.5 to V _{CC} | V |

NOTE: Permanent device damage may occur if ABSOLUTE MAXIMUM RATINGS are exceeded. Functional operation should be restricted to the conditions as detailed in the operational sections of this data sheet. Exposure to absolute maximum rating conditions for extended periods may affect device reliability.

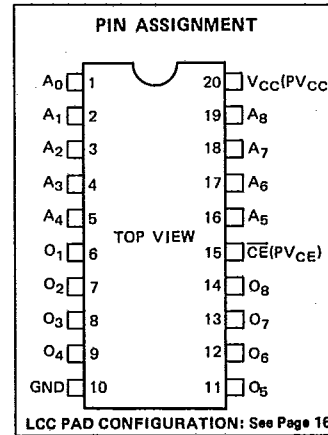
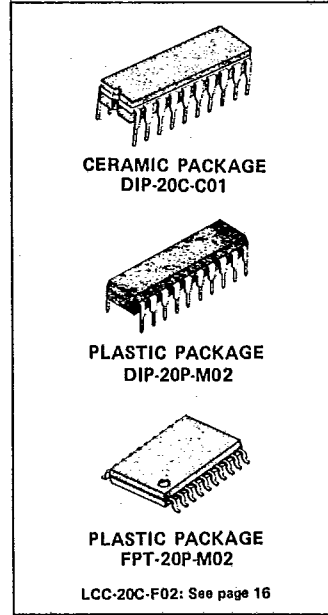

This device contains circuitry to protect the inputs against damage due to high static voltages or electric fields. However, it is advised that normal precautions be taken to avoid application of any voltage higher than maximum rated voltages to this high impedance circuit.

T-46-13-25

MB 7123E/H
MB 7124E/H/Y
MB 7123L
MB 7124L

1

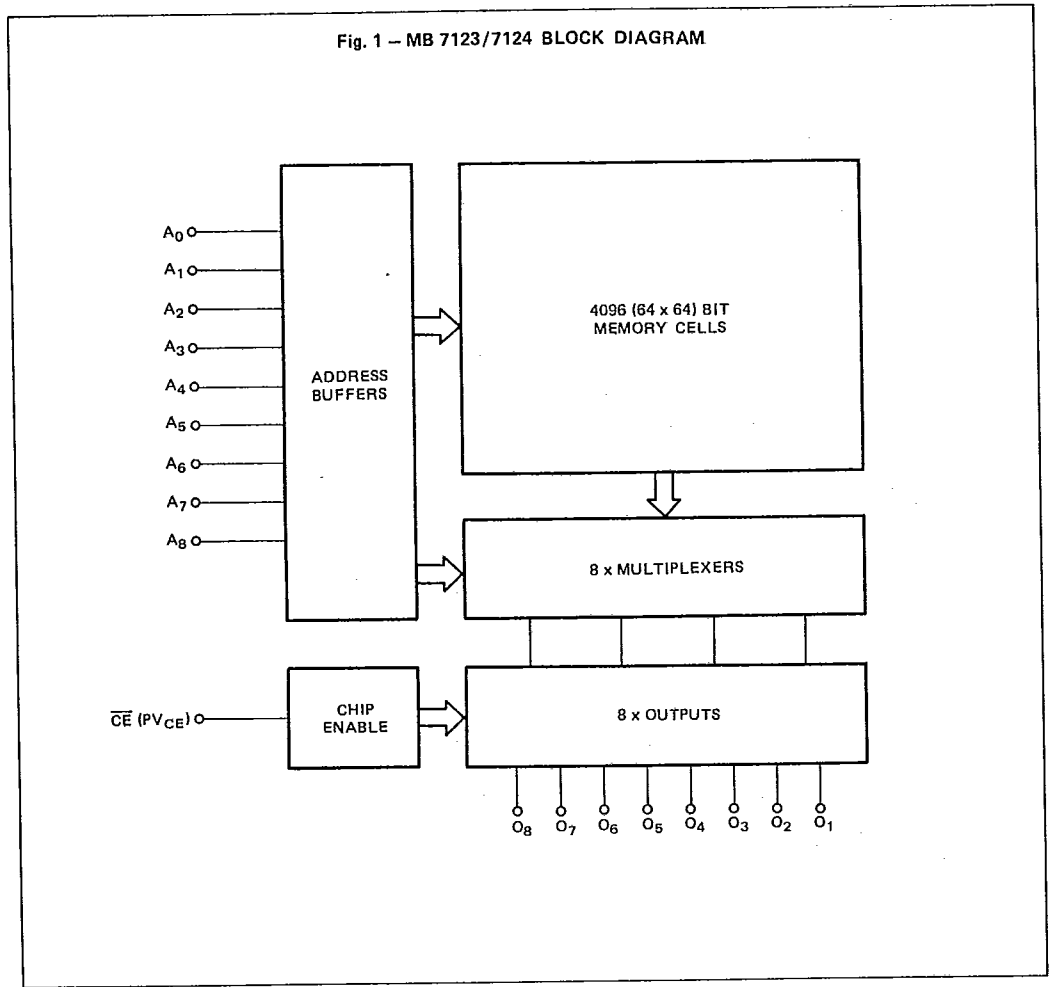

CAPACITANCE (f=1MHz, V_{CC}=+5V, V_{IN}=+2V, T_A=25°C)

| Parameter | Symbol | Min | Typ | Max | Unit |
|--------------------|----------------|-----|-----|-----|------|
| Input Capacitance | C _I | | | 10 | pF |
| Output Capacitance | C _O | | | 12 | pF |

T-46-13-25

MB 7123E/H
 MB 7124E/H/Y
 MB 7123L
 MB 7124L

FUJITSU

GUARANTEED OPERATING CONDITIONS

| Parameter | Symbol | Min | Typ | Max | Unit |
|---------------------|----------|------|-----|------|------|
| Supply Voltage | V_{CC} | 4.75 | 5.0 | 5.25 | V |
| Input Low Voltage | V_{IL} | | | 0.8 | V |
| Input High Voltage | V_{IH} | 2.0 | | | V |
| Ambient Temperature | T_A | 0 | | 75 | °C |

DC CHARACTERISTICS

(Full guaranteed operating conditions unless otherwise noted.)

| Parameter | Symbol | Min | Typ | Max | Unit | |
|--|----------------------|----------|-----|------|---------|----|
| Input Leakage Current ($V_{IH} = 5.5V$) | I_R | | | 40 | μA | |
| Input Load Current ($V_{IL} = 0.45V$) | I_F | | | -250 | μA | |
| Output Low Voltage ($I_{OL} = 10mA$) | V_{OL} | | | 0.45 | V | |
| Output Low Voltage ($I_{OL} = 16mA$) | V_{OL} | | | 0.50 | V | |
| Output Leakage Current ($V_O = 2.4V$, chip disabled) | MB 7123 I_{OLK} | | | 40 | μA | |
| Output Leakage Current ($V_O = 2.4V$, chip disabled) | MB 7124 I_{OIH} | | | 40 | μA | |
| Output Leakage Current ($V_O = 0.45V$, chip disabled) | MB 7124 I_{OIL} | | | -40 | μA | |
| Input Clamp Voltage ($I_{IN} = -18mA$) | V_{IC} | | | -1.2 | V | |
| Power Supply Current ($V_{IN} = OPEN$ or GND) | E/H/Y | I_{CC} | | 120 | 170 | mA |
| | L | | | 60 | 75 | |
| Output High Voltage ($I_O = -2.4mA$) | MB 7124 V_{OH*} | 2.4 | | | V | |
| Output Short Circuit Current ($V_O = GND$) | MB 7124 I_{OS*} | -15 | | -60 | mA | |

*Note: Denotes guaranteed characteristics of the output high-level (ON) state when the chip is enabled ($V_{ICE}=0.4V$) and the programmed bit is addressed.

These characteristics cannot be tested prior to programming, but are guaranteed by factory testing.

T-46-13-25



MB 7123E/H
MB 7124E/H/Y
MB 7123L
MB 7124L

Fig. 2 - AC TEST CONDITIONS

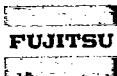
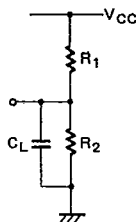

INPUT CONDITIONS
 Amplitude 0V to 3V
 Rise and Fall Time 5ns from 1V to 2V
 Frequency 1MHz

| | MB 7123/7124 | | |
|------------------|----------------|----------------|----------------|
| | R ₁ | R ₂ | C _L |
| t _{AA} | 300Ω | 600Ω | 30pF |
| t _{DIS} | 300Ω | 600Ω | 30pF |
| t _{EN} | 300Ω | 600Ω | 30pF |

AC CHARACTERISTICS

(Full guaranteed operating conditions unless otherwise noted.)

| Parameter | Symbol | L | | E | | H | | MB 7124Y | | Unit |
|---------------------------------|------------------|-----|-----|-----|-----|-----|-----|----------|-----|------|
| | | Typ | Max | Typ | Max | Typ | Max | Typ | Max | |
| Access Time (via address input) | t _{AA} | 35 | 60 | 25 | 45 | 25 | 35 | 25 | 30 | ns |
| Output Disable Time | t _{DIS} | 20 | 40 | 15 | 30 | 15 | 30 | 15 | 25 | ns |
| Output Enable Time | t _{EN} | 20 | 40 | 15 | 30 | 15 | 30 | 15 | 25 | ns |

OPERATION TIMING DIAGRAM

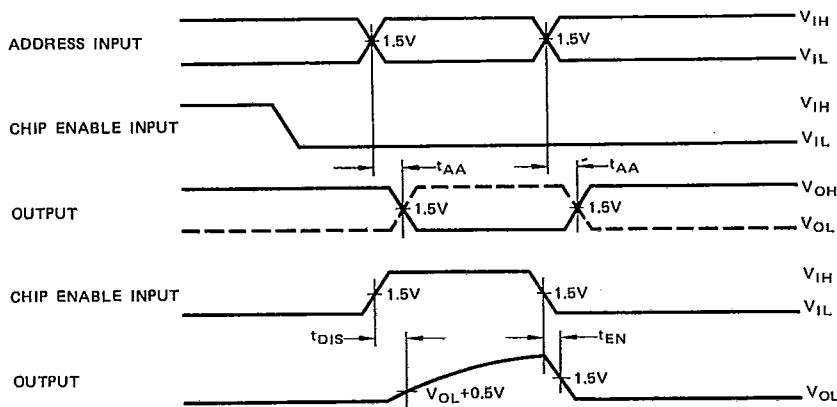

Note: Output disable time is the time taken for the output to reach a high resistance state when chip enable is taken high. Output enable time is the time taken for the output to become active when

chip enable is taken low. The high resistance state is defined as a point on the output waveform equal to a ΔV of 0.5V from the active output level.

T-46-13-25

MB 7123E/H
 MB 7124E/H/Y
 MB 7123L
 MB 7124L

FUJITSU
 FUJITSU

INPUT/OUTPUT CIRCUIT INFORMATION

1

INPUT

In the input circuit, Schottky TTL circuit technology is used to achieve high-speed operation. A PNP transistor in the first stage of input circuit remarkably improves input high/low current characteristics. Also, the input circuit includes a protection diode for reliable operation.

OPEN-COLLECTOR OUTPUT

The open-collector output is often utilized in high speed applications where power dissipation must be minimized. When the device is switched, there is no current sourced from the supply rail. Consequently, the current spike normally associated with TTL totem-pole outputs is eliminated. In high frequency applications, this minimizes noise problems (false triggering) as well as power drain. For example, the transient current (low impedance high-level to low impedance low-level) is typically 30mA for the MB 7124 (3-state) compared to 0mA for the MB 7123 (open-collector).

THREE-STATE OUTPUT

A "three-state" output is a logic element which has three distinct output states of ZERO, ONE and OFF (wherein OFF represents a high impedance condition which can neither sink nor source current at a definable logic level). Effectively, then, the device has all the desirable features of a totem-pole TTL output (e.g., greater noise immunity, good rise time, line driving capacity), plus the ability to connect to bus-organized systems.

In the case where two devices are on at the same time, the possibility exists

Fig. 3 - MB 7123/7124 INPUT

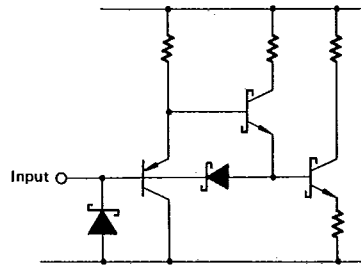
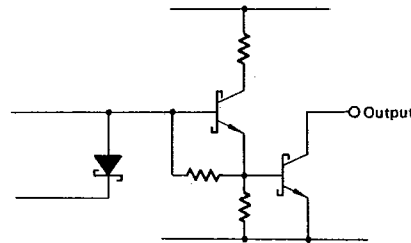

Fig. 4 - MB 7123 OUTPUT



T-46-13-25

FUJITSU
 MB 7123E/H
 MB 7124E/H/Y
 MB 7123L
 MB 7124L

1

that they may be in opposite low impedance states simultaneously; thus, the short circuit current from one enabled device may flow through the other enabled device. While physical damage under these conditions is unlikely, system noise problems could result. Therefore, the system designer should consider these factors to ensure that this condition does not exist.

Also in the output circuit, Schottky TTL circuit technology is used to achieve high-speed operation. Also, a PNP transistor provided in the output circuit is effective to decrease a load for the Chip Enable circuit.

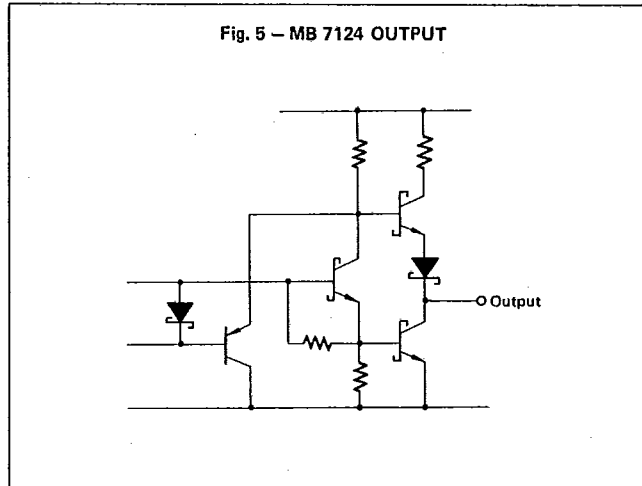

Fig. 5 - MB 7124 OUTPUT

TYPICAL CHARACTERISTICS CURVES

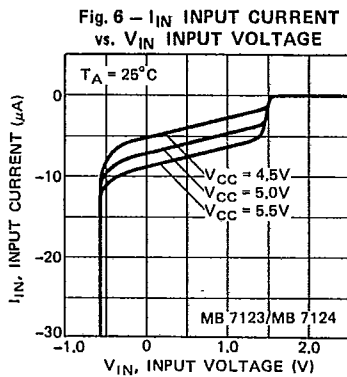

Fig. 6 - I_{IN} INPUT CURRENT vs. V_{IN} INPUT VOLTAGE

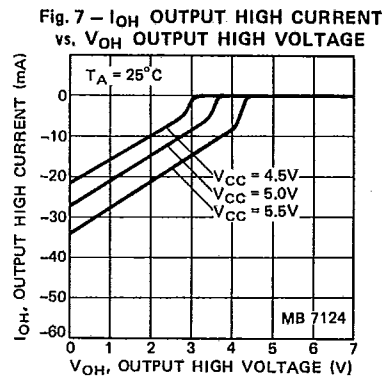
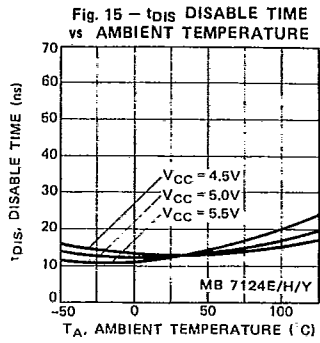
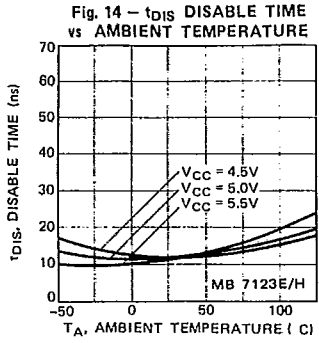
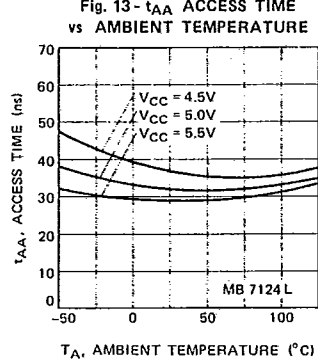
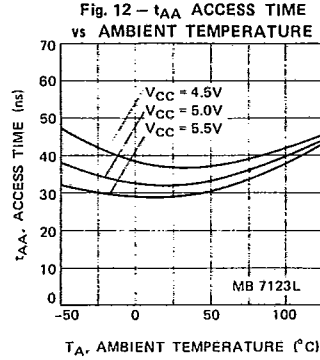
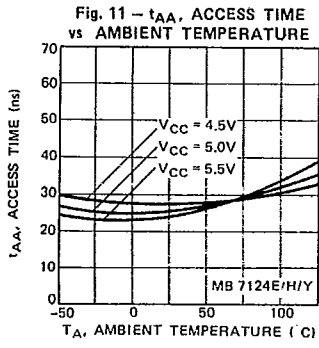
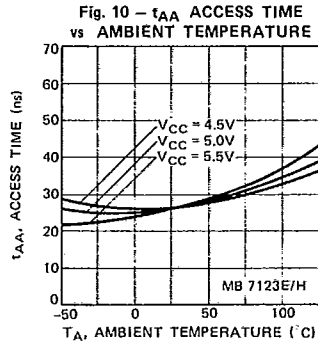
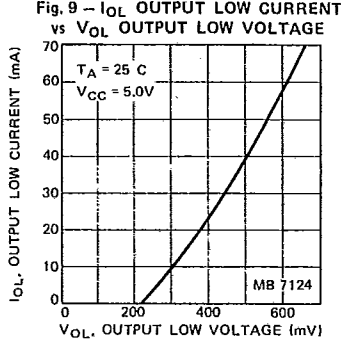
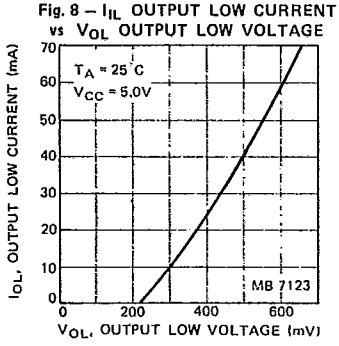

Fig. 7 - I_{OH} OUTPUT HIGH CURRENT vs. V_{OH} OUTPUT HIGH VOLTAGE

T-46-13-25

MB 7123E/H
 MB 7124E/H/Y
 MB 7123L
 MB 7124L
 FUJITSU



T-46-13-25

MB 7123E/H
MB 7124E/H/Y
FUJITSU MB 7123L
MB 7124L

1

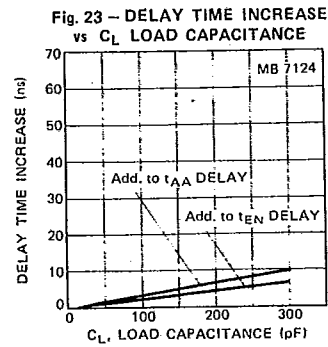
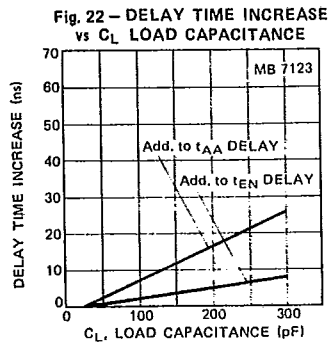
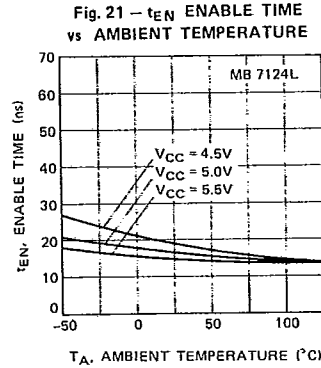
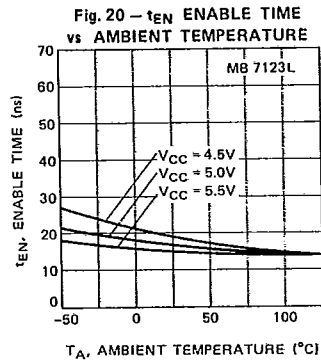
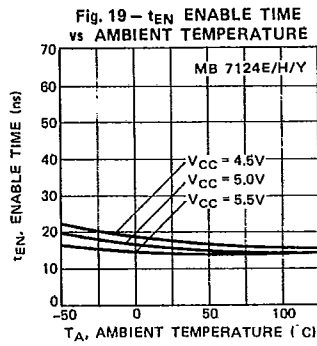
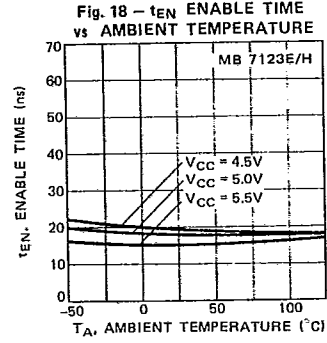
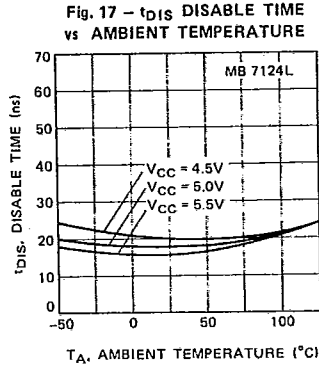
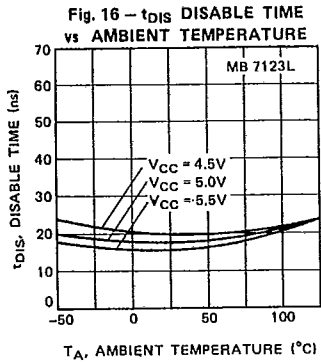

T-46-13-25

MB 7123E/H
 MB 7124E/H/Y
 MB 7123L
 MB 7124L



PROGRAMMING INFORMATION

1

FUJITSU PROM TECHNOLOGY

The Fujitsu MB 7100 series is the junction-shortening Schottky PROM. A memory cell consists of a programmable element of a PN diode and a vertically connected PNP transistor. The current blocking state of the reverse diode is changed to the current conducting state of the shorted-conducting diode by programming. The programming element of the PN diode uses the N⁺ and P⁺ diffusion layer, the PNP transistor uses a P⁺ diffusion layer, and N⁺ epitaxial layer, and a P⁻ substrate (Fig. 24).

Each word line island is divided by passive isolations named IOP (Isolation by Oxide and Poly-silicon), and each memory cell in the same island is divided by the passive isolation named SVG (Shallow V-Groove). The vertical structure of the junction-shortening memory cell makes a high packing density possible.

In programming, reverse current pulses are applied to the cathode of the PN diode. This increases the temperature at the junction. When the temperature reaches the point where the silicon and aluminum form a eutectic, the eutectic diffuses from the surface of the metal-silicon contact region to the anode of the PN diode and results in junction shorting. This program technique was therefore named "Diffused Eutectic Aluminum Process" (DEAP).

Once the junction is shorted, the power dissipation at the junction decreases to less than one fifth, and the temperature decreases. This drop in temperature stops further diffusion of the eutectic, and protects the PNP transistor from destruction.

SPECIAL FACTORY TESTING

Extra rows and extra columns of test cells, plus additional circuitry built into the PROM chip, allow improved factory testing of DC, AC and programming characteristics. These test

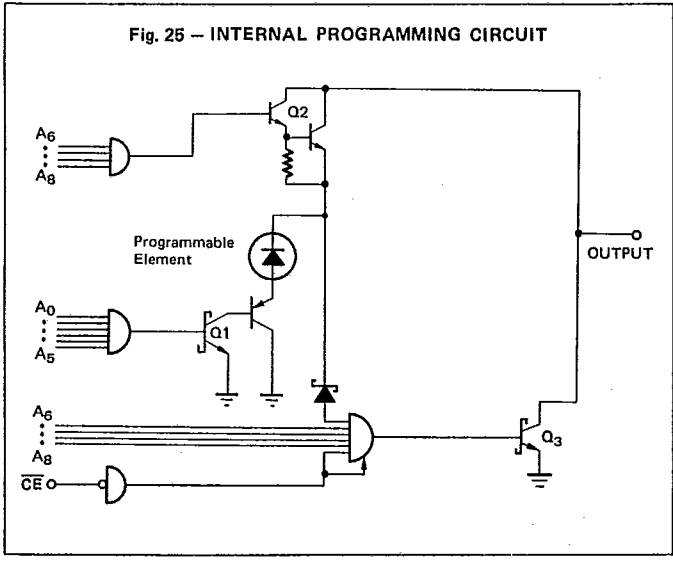
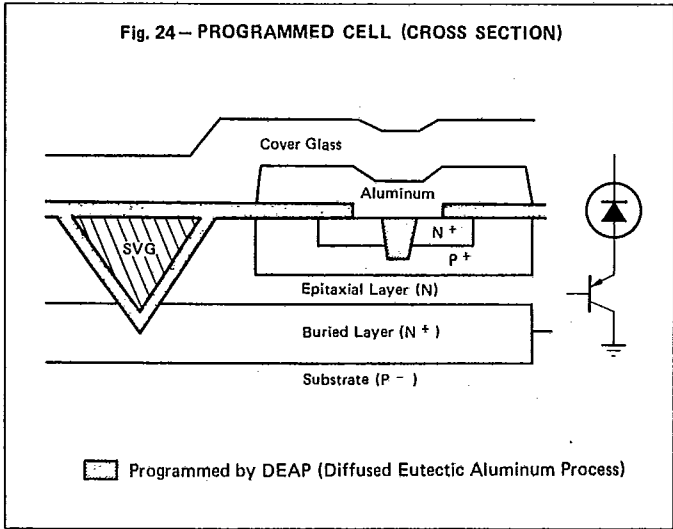

T-46-13-25

MB 7123E/H
MB 7124E/H/Y
MB 7123L
MB 7124L

1 PROGRAMMING INFORMATION (continued)

cells and test circuitry provide enhanced correlation between programmed and unprogrammed circuits in order to guarantee high programmability and reliability.

PROGRAMMING (in electrical view)

The device is manufactured with outputs low (positive logic "zero") in all storage cells. An output at the selected cell is changed to high (logic "one") by programming.

"As shown in Fig. 25, transistors, Q_1 and Q_2 , are turned on to select the desired bit for programming by using nine address inputs. By applying the PV_{CE} pulse voltage, the chip is disabled and transistor Q_3 is held off. Then, a train of programming pulses applied to the desired output flows through transistor Q_2 and memory cell

into transistor Q_1 . This programming current changes the programmable element to the conducting state.

The pulse train is stopped and two additional programming pulses are then applied to assure that the element is programmed properly, as soon as the output voltage indicates that the selected cell is in the logic "one" state. One output must be programmed at a time since the internal decoding circuit is capable of sinking only one unit of programming current at a time.

VERIFICATION

After the device has been programmed, the correct program pattern can be verified by taking chip enable input low. To guarantee full supply voltage and full temperature range operation, a programmed device should source

2.4mA at $V_{OH}=2.4V$ and $V_{CC}=7.0V$ at 25°C ambient temperature.

LIABILITY

Fujitsu utilizes an extensive testing procedure to ensure device performance prior to shipment. However, 100% programmability is not guaranteed, and it is imperative that this specification be rigorously adhered to in order to achieve a satisfactory programming yield. Fujitsu will not accept responsibility for any device found defective if it was not programmed according to this specification. Devices returned to Fujitsu as defective must be accompanied by a complete truth table with clearly indicated locations of supposedly defective memory cells.

DC SPECIFICATIONS ($T_A = 25^\circ C$)

| Parameter | Symbol | Min | Typ | Max | Unit | |
|-----------------------------------|-----------|-----|------|------|------|---|
| Input Low Voltage | V_{IL} | 0 | — | 0.8 | V | |
| Input High Voltage | V_{IH} | 2.0 | — | 5.25 | V | |
| Power Supply Voltage | PV_{CC} | P: | 6.7 | 7.0 | 7.3 | V |
| | | R: | 4.75 | 5.0 | 5.25 | |
| Programming Pulse Current | I_{PRG} | 120 | 125 | 130 | mA | |
| PV_{CE} Pulse Voltage | PV_{CE} | 20 | 20 | 22 | V | |
| Programming Pulse Clamp Voltage | V_{PRG} | 20 | 20 | 22 | V | |
| PV_{CE} Pulse Clamp Current | PI_{CE} | 230 | — | 260 | mA | |
| Reference Voltage for a Prog. "1" | V_{REF} | 1.0 | 1.5 | 2.4 | V | |

T-46-13-25

MB 7123E/H
 MB 7124E/H/Y
 MB 7123L
 MB 7124L



1

AC SPECIFICATIONS ($T_A = 25^\circ\text{C}$)

| Parameter | Symbol | Min | Typ | Max | Unit |
|--|-------------|-----|-----|------|-------------------|
| Programming Pulse Cycle Time | t_{CYC} | 40 | 50 | 60 | μs |
| Programming Pulse Width | $t_{PW(1)}$ | 10 | 11 | 12 | μs |
| Programming Pulse Rise Time | $t_r(2)$ | | | 2 | μs |
| PV _{CE} Pulse Rise Time | $t_r(2)$ | | | 2 | μs |
| PV _{CC} Pulse Rise Time | $t_r(3)$ | | | 2 | μs |
| Programming Pulse Fall Time | $t_f(4)$ | | | 2 | μs |
| PV _{CE} Pulse Fall Time | $t_f(4)$ | | | 2 | μs |
| PV _{CC} Pulse Fall Time | $t_f(5)$ | | | 2 | μs |
| Address Input Set-up Time | t_{SA} | 2 | | | μs |
| Chip Enable Input Set-up Time | t_{SC} | 2 | | | μs |
| PV _{CE} Set-up Time | $t_{SP(6)}$ | 4 | | | μs |
| Address Input Hold Time | t_{HA} | 2 | | | μs |
| Chip Enable Input Hold Time | t_{HC} | 2 | | | μs |
| PV _{CE} Hold Time | $t_{HP(7)}$ | 2 | | | μs |
| PV _{CE} Pulse Trailing Edge to Read Strobe Time | $t_{PR(8)}$ | 10 | | | μs |
| Programming Pulse Number | | | | 100 | Times |
| Programming Time/Bit | | 120 | 150 | 6120 | $\mu\text{s/bit}$ |
| Additional Programming Pulse Number | | 2 | 2 | 2 | Times |

Notes: (1) Stipulated 200 Ω load and 15V.(2) From 1V to 19V (200 Ω load).(3) From 5.2V to 6.8V (30 Ω load).(4) From 19V to 1V (200 Ω load).(5) From 6.8V to 5.2V (30 Ω load).(6) From PV_{CE} pulse 19V to programming pulse 1V.(7) From programming pulse 1V to PV_{CE} pulse 19V.(8) From PV_{CE} pulse 1V to read strobe.

T-46-13-25

FUJITSU MB 7123E/H
 MB 7124E/H/Y
 MB 7123L
 MB 7124L

PROGRAMMING INFORMATION (continued)

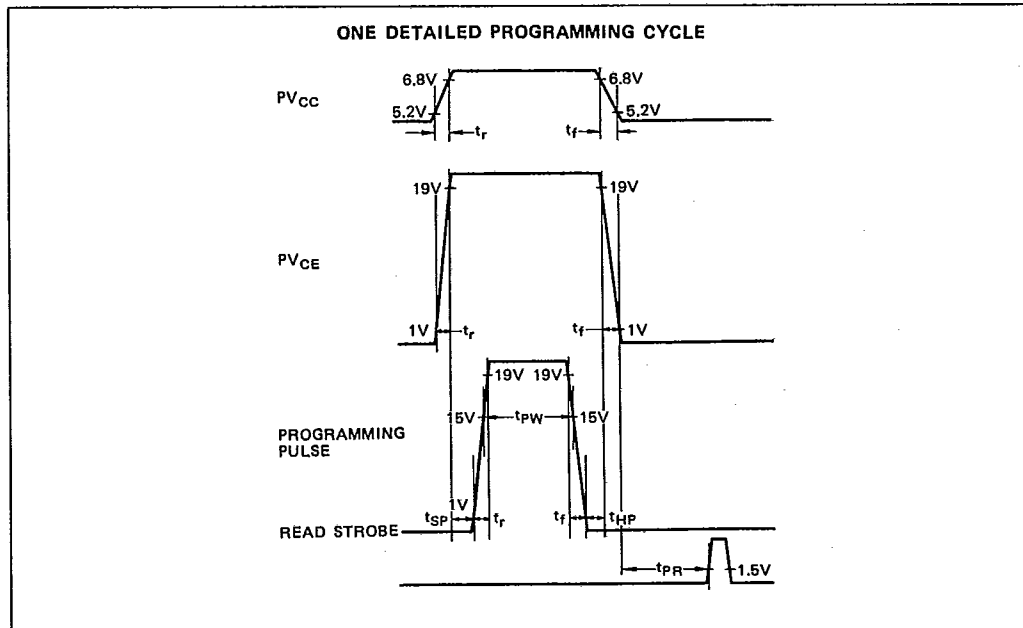
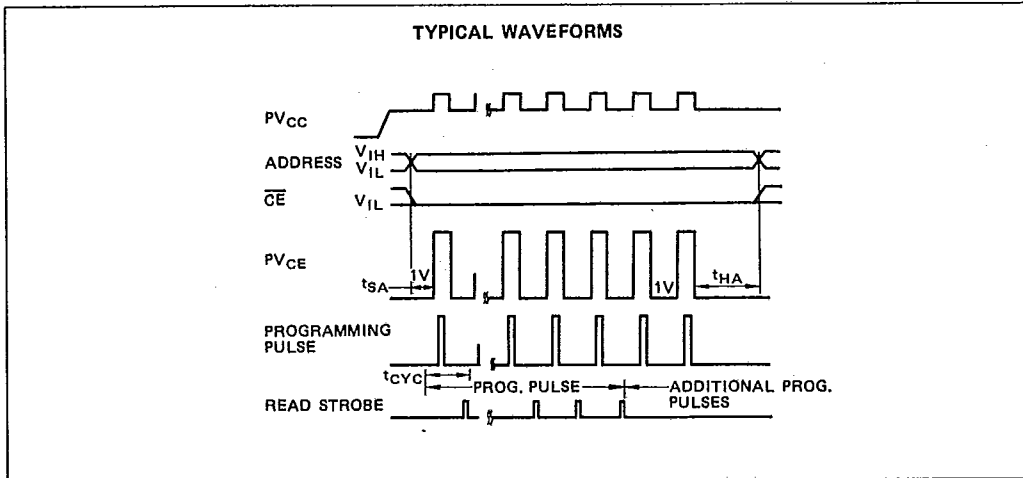

T-46-13-25
 MB 7123E/H
 MB 7124E/H/Y
 MB 7123L
 MB 7124L

FUJITSU

1

PROGRAMMING PROCEDURE

1. Apply power; $V_{CC} = PV_{CC}$, $GND = 0V$.
2. Select the desired bit.
3. Read the output to confirm the voltage $V_O = \text{low}$. (In the case of $V_O = \text{high}$, select the next desired bit.)
4. Apply a 20V pulse voltage to the PV_{CE} input.
5. Apply a programming pulse with amplitude of 120 mA and duration of t_{PW} ($10\mu s$) after a delay of t_{SP} ($4\mu s$).
6. Read the output V_O after a delay of t_{PR} ($10\mu s$).
 - a) In the case of $V_O = \text{low}$, repeat steps "4", "5" and "6" with cycle time of t_{CYC} ($50\mu s$).
 - b) In the case of $V_O = \text{high}$, apply 2 additional programming pulses to provide a highly reliable memory cell.
7. Select the next desired bit after a delay of t_{HA} ($2\mu s$).

- Note 1) Programming must be done bit by bit.
 Note 2) Ambient temperature during programming must be room temperature. ($25^{\circ}C \pm 2^{\circ}C$)

Fig. 26 - PROGRAMMING FLOW CHART

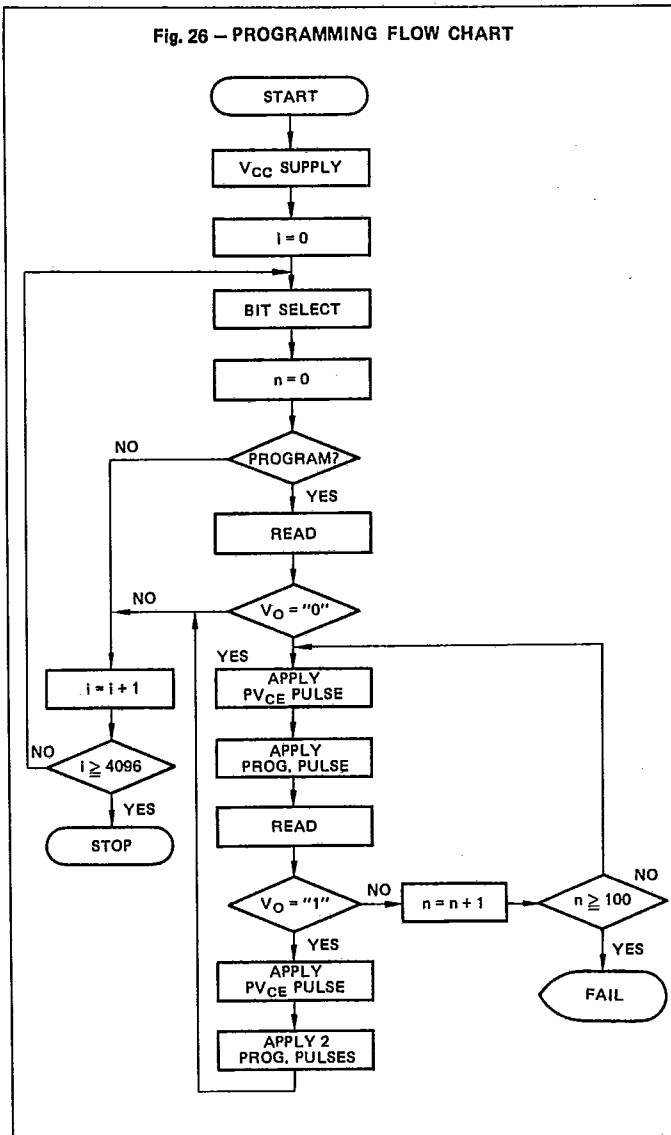

T-46-13-25

FUJITSU
 MB 7123E/H
 MB 7124E/H/Y
 MB 7123L
 MB 7124L

PACKAGE DIMENSIONS

CERAMIC DIP (:-Z)

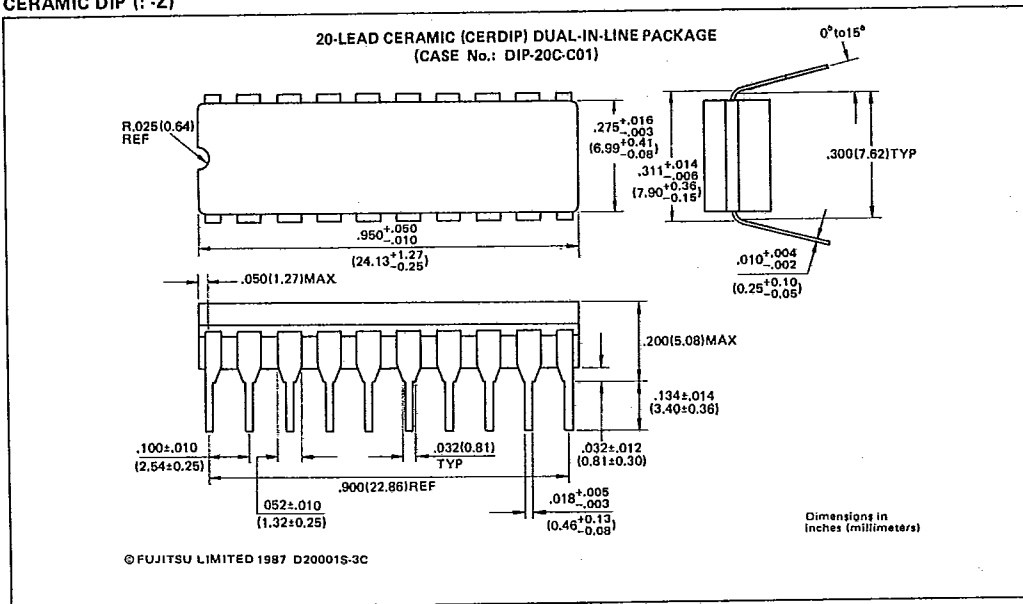

PLASTIC DIP (:-P)

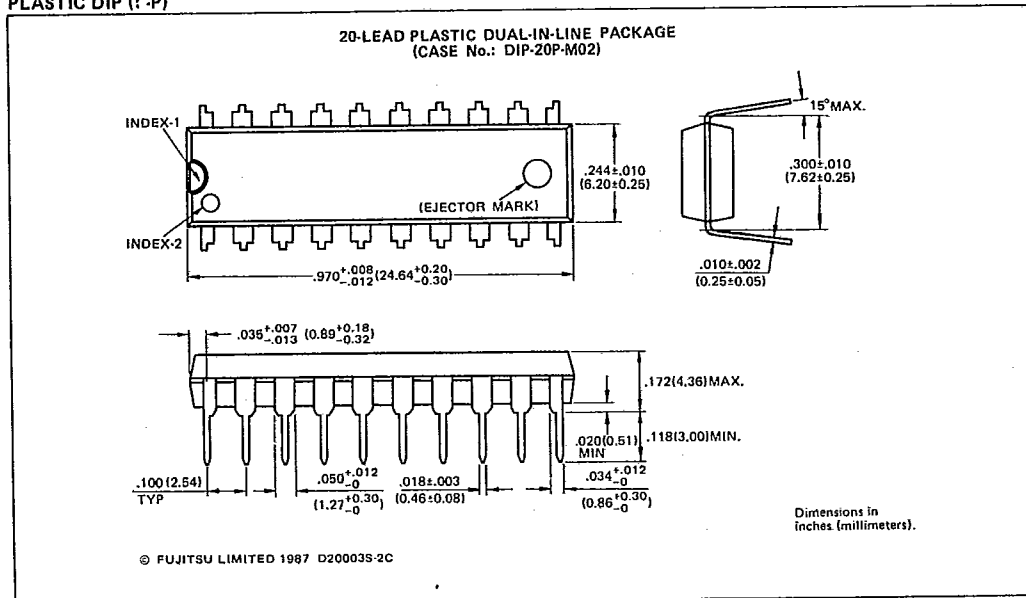

T-46-13-25

MB 7123E/H
 MB 7124E/H/Y
 MB 7123L
 MB 7124L



PACKAGE DIMENSIONS

PLASTIC FPT (: -PF)

1

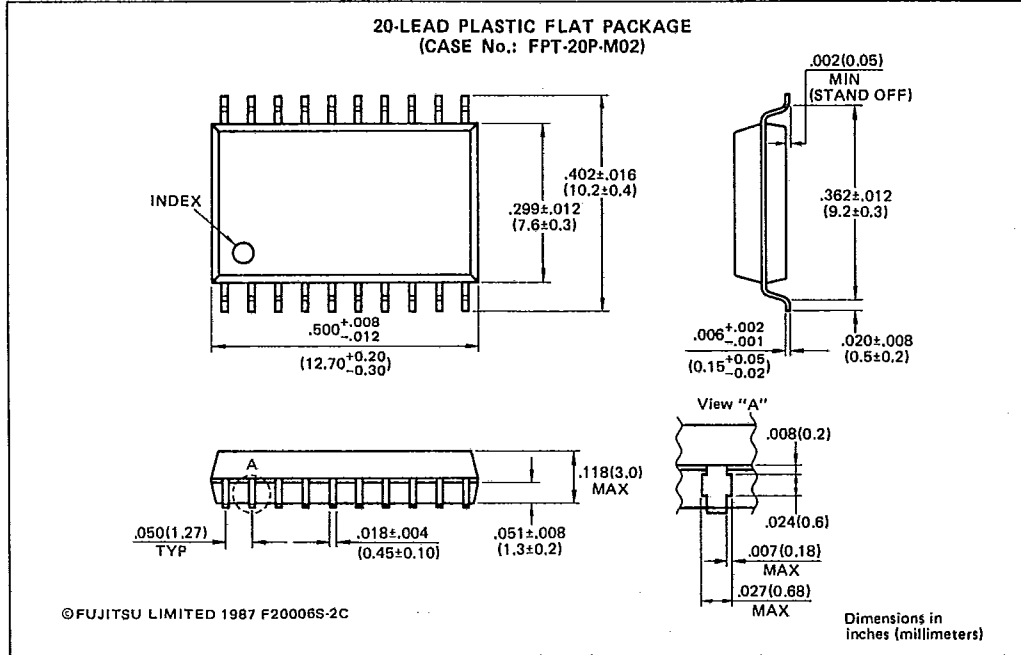

T-46-13 -25

FUJITSU
MB 7123E/H
MB 7124E/H/Y
MB 7123L
MB 7124L

1

PACKAGE DIMENSIONS

CERAMIC LCC (-TV)

