

FEATURES

- Tight Output Voltage Tolerance
- Low Output Noise
- Operating Current 60 μ A to 100mA
- Low Dynamic Impedance
- Low Temperature Coefficient
- Available in the sub-miniature SOT-23 Package
- 2.5V Device (AMS4040) also available

APPLICATIONS

- Battery Powered Systems
- Instrumentation
- Energy Management
- Automotive
- Precision Audio Components
- Product Testing
- Data Acquisition Systems

GENERAL DESCRIPTION

The AMS4041 is a two-terminal micropower band-gap voltage reference diode featuring a very low dynamic impedance and good temperature coefficient, operating over a 60 μ A to 100mA current range. On-chip trimming is used to provide tight voltage tolerance. Since the AMS4041 band-gap reference uses only transistors and resistors, low noise and good long term stability result. The wide dynamic operating range allows its use with widely varying supplies with excellent regulation. The extremely low power drain of the AMS4041 makes these reference diodes useful for micropower circuitry. These voltage references can be used to make portable meters, regulators or general purpose analog circuitry with battery life approaching shelf life.

The AMS4041 is operational in the full industrial temperature range of -40°C to 85°C and is available in small space saving TO-92, SO-8, SOT-89 and SOT-23 packages.

ORDERING INFORMATION:

TOL.	PACKAGE TYPE				OPERATING TEMP. RANGE
	TO-92	8 LEAD SOIC	SOT-89	3 LEAD SOT-23	
$\pm 0.25\%$	AMS4041AN	AMS4041AS	AMS4041AL	AMS4041AM	-40 to +85° C
$\pm 0.5\%$	AMS4041BN	AMS4041BS	AMS4041BL	AMS4041BM	-40 to +85° C
$\pm 1.0\%$	AMS4041CN	AMS4041CS	AMS4041CL	AMS4041CM	-40 to +85° C

PIN CONNECTIONS

TO-92
Plastic Package (N)

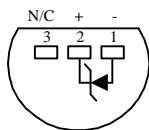

Bottom View

8L SOIC
SO Package (S)

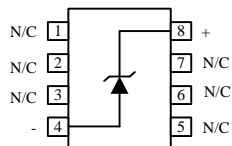

Top View

SOT-89
(L)

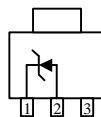

Top View

3L SOT-23
(M)

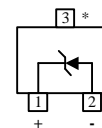

Top View

*This pin must be left floating or connected to pin 2

ABSOLUTE MAXIMUM RATINGS (Note 1)

Reverse Current	100mA	Internal Power Dissipation (P_D)	
Forward Current	10mA	TO-92 Package	0.78W
Storage temperature	-65°C to +150°C	SO-8 Package	0.71W
Lead Temperature		SOT-89 Package	0.91W
TO-92 package (Soldering 10 sec.)	265°C	SOT-23 Package	0.28W
SO-8 and SOT-23 packages:		Thermal Resistance (θ_{JA})	
Vapor phase (60 sec)	215°C	TO-92 Package	160°C/W
Infrared (15 sec.)	220°C	SO-8 Package	175°C/W
SOT-89 package (Soldering 10 sec.)	265°C	SOT-89 Package	110°C/W
		SOT-23 Package	410°C/W

Note1: Absolute Maximum Ratings indicate limits beyond which damage to the device may occur. For guaranteed specifications and test conditions, see the Electrical Characteristics. The guaranteed specifications apply only for the test conditions listed.

ELECTRICAL CHARACTERISTICS

Electrical Characteristics at $I_R = 100 \mu A$ and $T_A = +25^\circ C$ unless otherwise specified.

Parameter	Conditions	AMS4041A			AMS4041B			AMS4041C			Units
		Min	Typ	Max	Min	Typ	Max	Min	Typ	Max	
Reverse Breakdown Voltage		1.222	1.225	1.228	1.219	1.225	1.231	1.213	1.225	1.237	V
Deviation of Reverse Breakdown Voltage over Temperature	$T_A = \text{Full Range}$		8.0	17		8.0	17		8.0	25	mV
Reverse Breakdown Voltage Change with Operating Current Change	$I_{RMIN} \leq I_R \leq 1mA$		0.7	1.5		0.7	1.5		0.7	2.0	mV
	$1mA \leq I_R \leq 15mA$		4.0	6.0		2.5	6.0		2.5	8.0	mV
				8.0			8.0			10.0	
Reverse Breakdown Voltage Long Term Stability	$T_A = 25^\circ C \pm 1^\circ C$ $T = 1000 \text{ Hr}$		120			120			120		ppm
Wide Band Noise	$10\text{HZ} \leq f \leq 10\text{kHz}$		20			20			20		μV_{rms}
Reverse Dynamic Impedance	$I_R = 1mA, f = 120\text{Hz},$ $I_{AC} = 0.1I_R$		0.5	1.5		0.5	1.5		0.5	2.0	Ω
Minimum Operating Current			60	80		60	80		60	80	μA
				100			100			100	

Parameters identified with **boldface type** apply at temperature extremes. All other numbers apply at $T_A = T_J = 25^\circ C$.

TYPICAL APPLICATIONS

Shunt Regulator

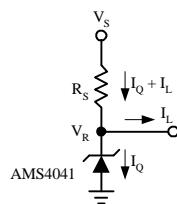

TYPICAL APPLICATIONS

Precision 1µA to 1mA Current Sources

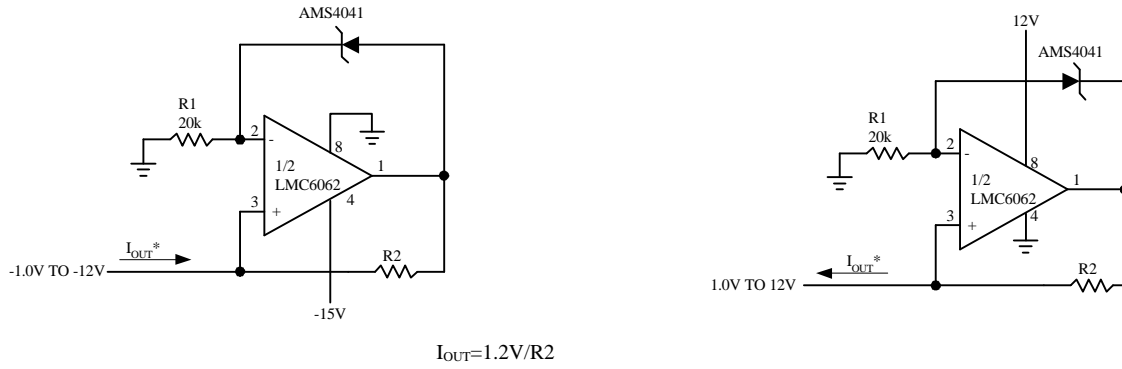

Programmable Current Source

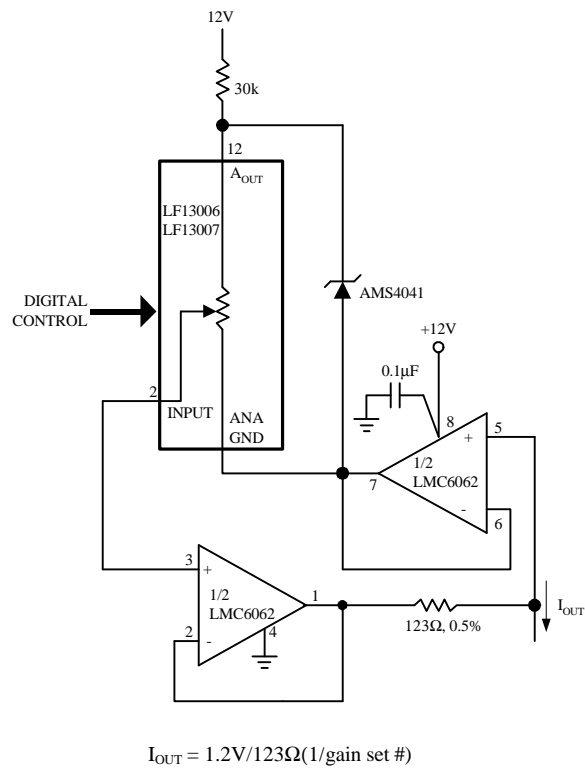

START-UP CHARACTERISTICS

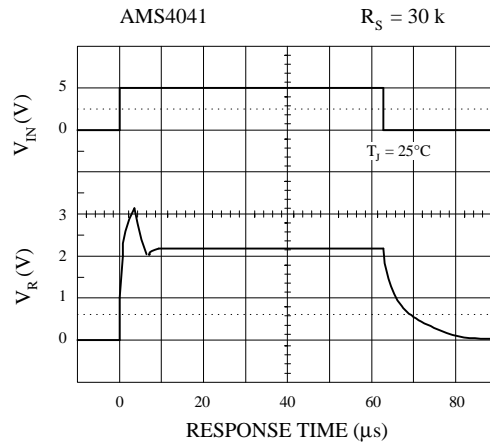
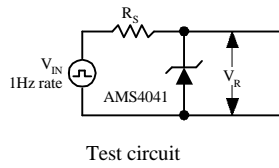

TYPICAL PERFORMANCE CHARACTERISTICS

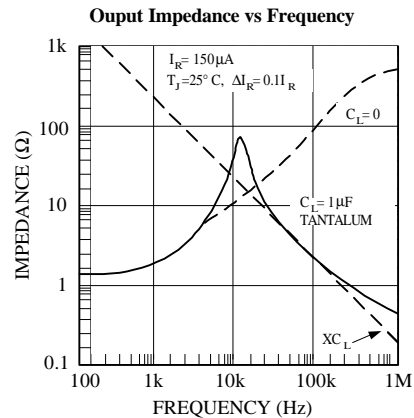
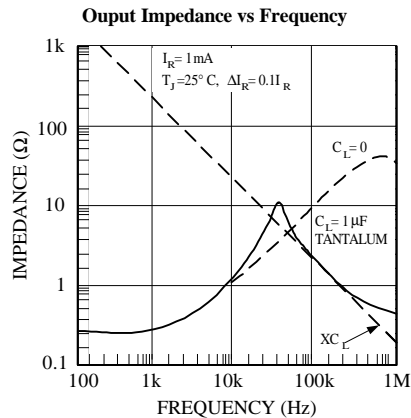
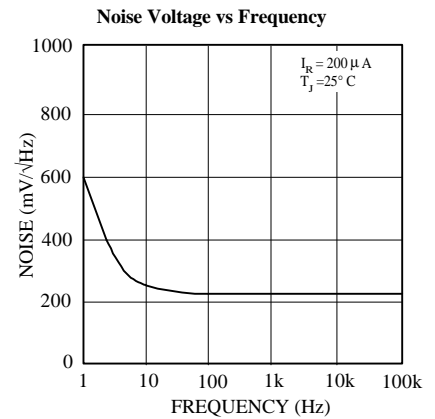
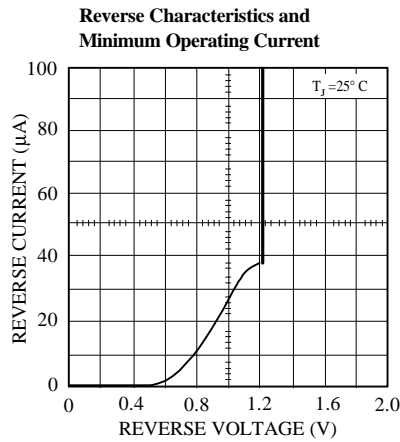
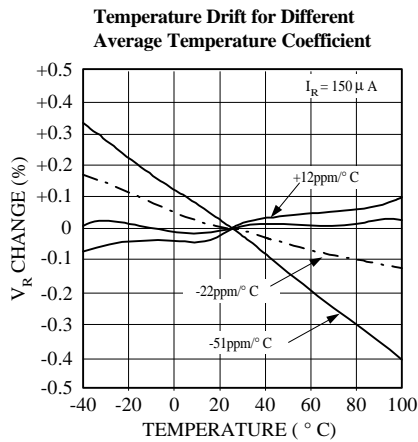

PACKAGE DIMENSIONS inches (millimeters) unless otherwise noted.

3 LEAD TO-92 PLASTIC PACKAGE (N)

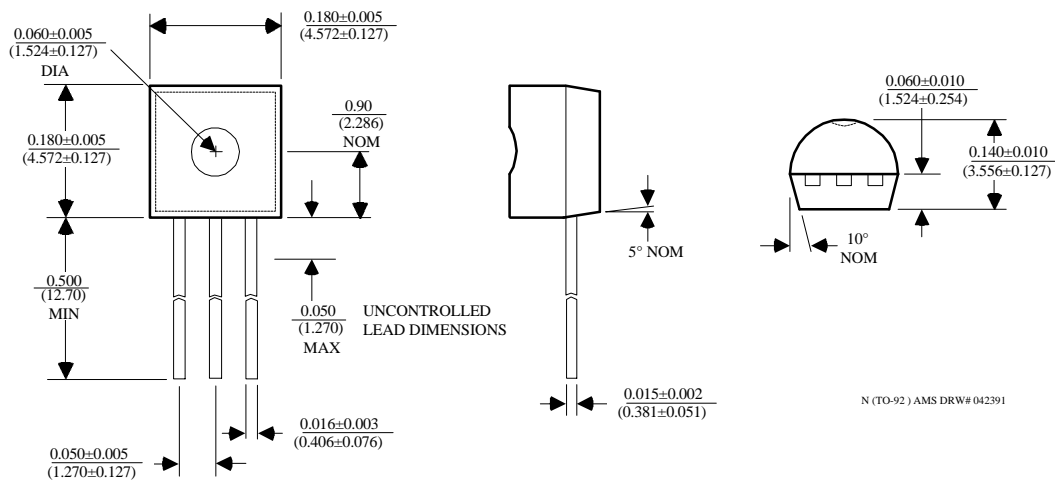

8 LEAD SOIC PLASTIC PACKAGE (S)

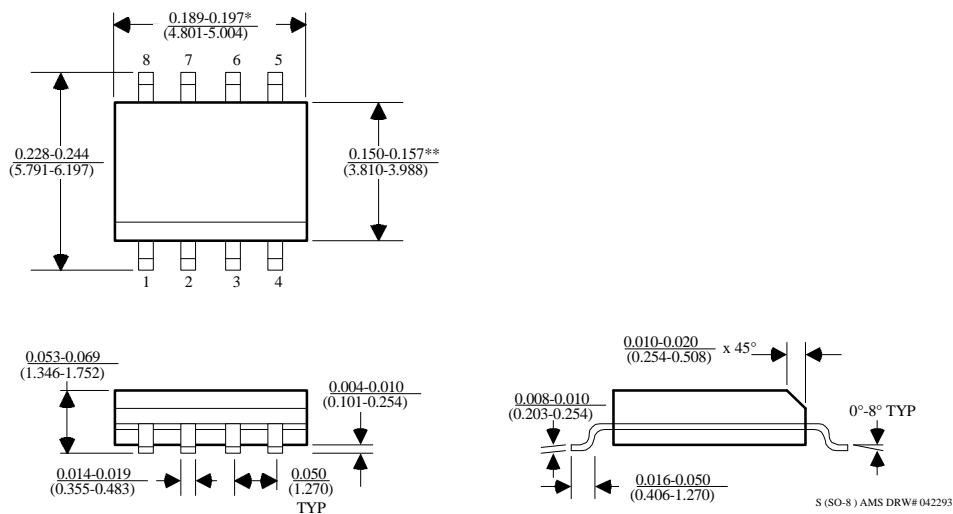

*DIMENSION DOES NOT INCLUDE MOLD FLASH. MOLD FLASH SHALL NOT EXCEED 0.006" (0.152mm) PER SIDE

**DIMENSION DOES NOT INCLUDE INTERLEAD FLASH. INTERLEAD FLASH SHALL NOT EXCEED 0.010" (0.254mm) PER SIDE

PACKAGE DIMENSIONS inches (millimeters) unless otherwise noted (Continued).

SOT-89 PLASTIC PACKAGE (L)

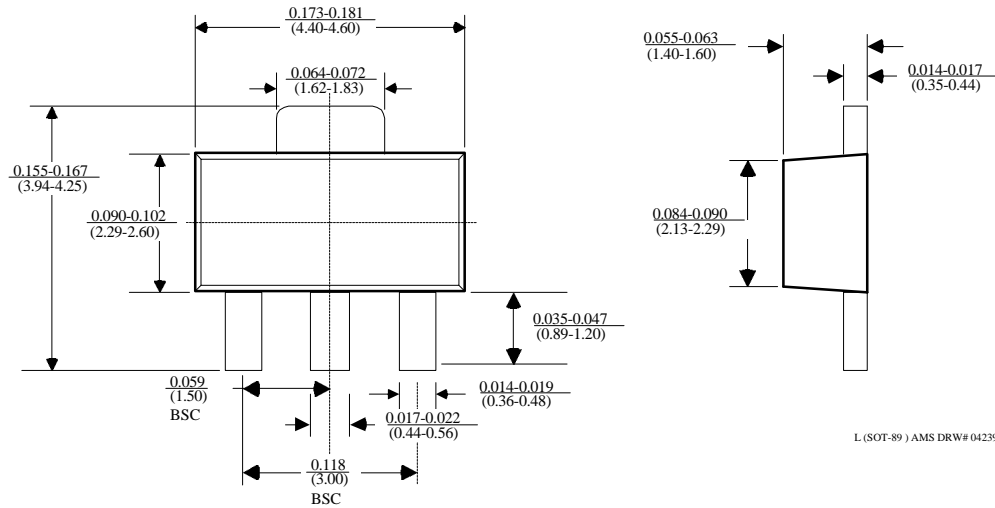

3 LEAD SOT-23 PLASTIC PACKAGE (M)

