

High Dynamic Range Low Noise Amplifier, 800 - 1000 MHz

**AM50-0003
V3**

Features

- Low Noise Figure: 1.2 dB
- High Input: +18 dBm at 8 V, 60 mA bias
+6.5 dBm at 3 V, 20 mA bias
- High Gain: 15 dB
- Single Supply: +3 to +8 VDC
- Low Cost SOIC-8 Plastic Package
- Adjustable current: 20 to 80 mA with external resistor

Description

M/A-COM's AM50-0003 is a high dynamic range, GaAs MMIC, low noise amplifier in a low cost, SOIC 8-Lead, surface mount, plastic package. It employs external input matching to obtain optimum noise figure performance and operating frequency flexibility. The AM50-0003 also features flexible biasing to control the current consumption vs. dynamic range trade-off. The AM50-0003 can operate from any supply voltage in the 3V to 8V range. Its current can be controlled over a range of 20 mA to 80 mA with an external resistor.

The AM50-0003 is ideally suited for use where low noise figure, high gain, high dynamic range, and low power consumption are required. Typical applications include receiver front ends in AMPS, GSM, and ETACS base stations. It is also useful as a gain block, buffer, driver, and IF amplifier in both fixed and portable cellular and 900 MHz ISM systems.

Ordering Information

Part Number	Package
AM50-0003	Bulk Packaging
AM50-0003TR	1000 piece reel
AM50-0003RTR	Reverse Tape and Reel
AM50-0003SMB	Sample Test Board

Note: Reference Application Note M513 for reel size information.

Functional Block Diagram

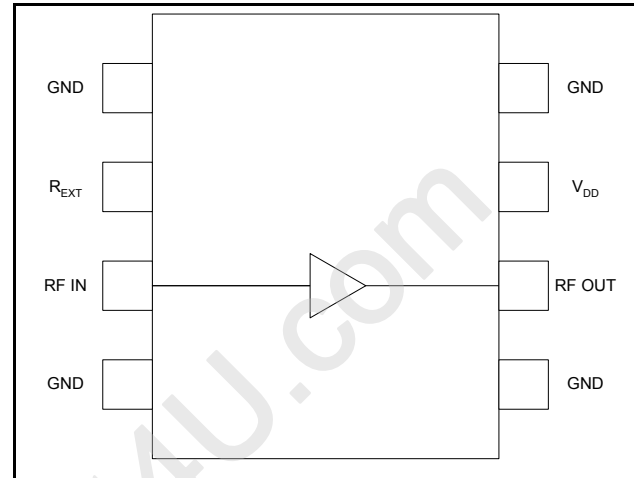

Pin Configuration

Pin No.	Pin Name	Description
1	GND	RF and DC Ground
2	R _{EXT}	External Current Control (optional)
3	RF IN	RF Input of the amplifier
4	GND	RF and DC Ground
5	GND	RF and DC Ground
6	RF OUT	RF Output of the amplifier
7	V _{DD}	Positive supply voltage
8	GND	RF and DC Ground

Absolute Maximum Ratings ¹

Parameter	Absolute Maximum
V _{DD}	+10 VDC
Input Power	+10 dBm
Current ²	120 mA
Channel Temperature ³	+150°C
Operating Temperature	-40°C to +85°C
Storage Temperature	-65°C to +150°C

1. Exceeding any one or combination of these limits may cause permanent damage.
2. When pin #2 is used to increase current. (see note 6)
3. Thermal resistance (θ_{jc}) = +88°C/W

**High Dynamic Range Low Noise Amplifier,
800 - 1000 MHz**

**AM50-0003
V3**

Electrical Specifications: $T_A = +25^\circ\text{C}$, $Z_0 = 50\ \text{Ohms}$, $F=900\ \text{MHz}$, $P_{in} = -30\ \text{dBm}$

Parameter	Test Conditions	Units	Min	Typ	Max
Gain	800 - 1000 MHz, 5 V, 60 mA ⁴	dB	13	15	—
	800 - 1000 MHz, 3 V, 20 mA	dB	12	13.5	—
Noise Figure	800 - 1000 MHz, 5 V, 60 mA ⁴	dB	—	1.20	1.50
	800 - 1000 MHz, 3 V, 20 mA	dB	—	1.25	1.50
Input VSWR	800 - 1000 MHz,	Ratio	—	2.0:1	—
Output VSWR	800 - 1000 MHz,	Ratio	—	1.5:1	—
Output 1 dB Compression	800 - 1000 MHz, 5 V, 60 mA ⁴	dBm	—	16.5	—
	800 - 1000 MHz, 3 V, 20 mA	dBm	—	8.5	—
Input IP3	800 - 1000 MHz, 5 V, 60 mA ⁴	dBm	12.5	15	—
	800 - 1000 MHz, 3 V, 20 mA	dBm	4.0	6.5	—
Reverse Location	800 - 1000 MHz,	dB	—	25	—

4. Using external 15 Ohm resistor. See functional block diagram herein.

Functional Schematic

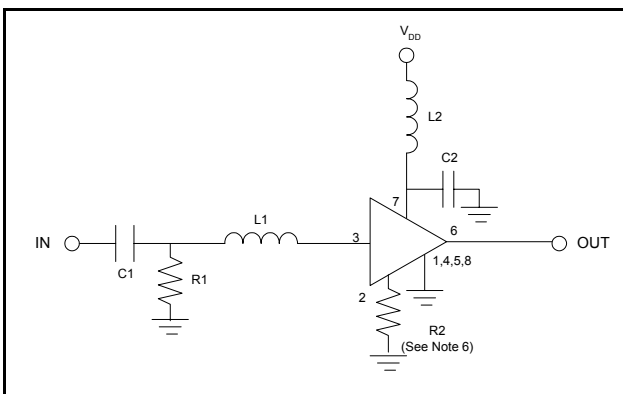

Handling Procedures

Please observe the following precautions to avoid damage:

Static Sensitivity

Gallium Arsenide Integrated Circuits are sensitive to electrostatic discharge (ESD) and can be damaged by static electricity. Proper ESD control techniques should be used when handling these devices.

Component List ⁵

Part	Value	Case Size	Manufacturer	Purpose
C1	47 pF	0603	Murata	DC Block
C2	470 pF	0603	Murata	By-Pass
L1	12 nH	0603	Coilcraft	Tuning
L2	12 nH	0603	Coilcraft	RF Choke
R1	5.1K Ohms	0603	Panasonic	DC Return
R2	See Note 6	0603	Panasonic	Optional current control

5. All External circuitry parts are readily available, low cost surface mount components (.060 in. x .030 in. or .080 in. x .050 in.)
6. Pin 2 allows use of an external resistor to ground for optional, higher current. For 20 mA operation, no resistor is used.
- For $I_{DD} \sim 40\ \text{mA}$, $R_2 = 43\ \text{ohms}$;
 $I_{DD} \sim 60\ \text{mA}$, $R_2 = 15\ \text{ohms}$;
 $I_{DD} \sim 80\ \text{mA}$, $R_2 = 10\ \text{ohms}$.

**High Dynamic Range Low Noise Amplifier,
800 - 1000 MHz**

**AM50-0003
V3**

Recommended PCB Configuration

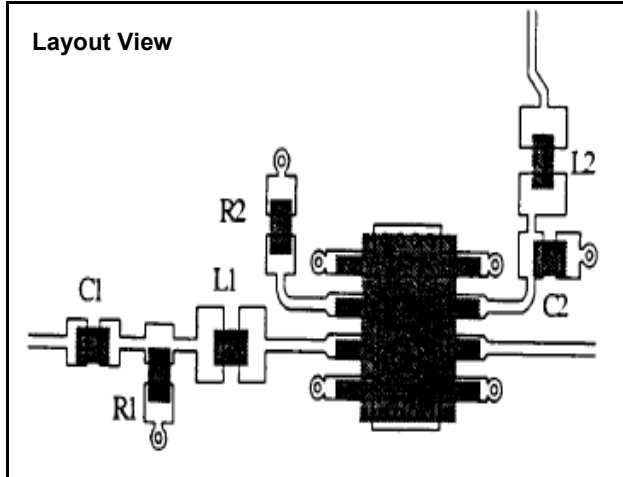

Cross Section View

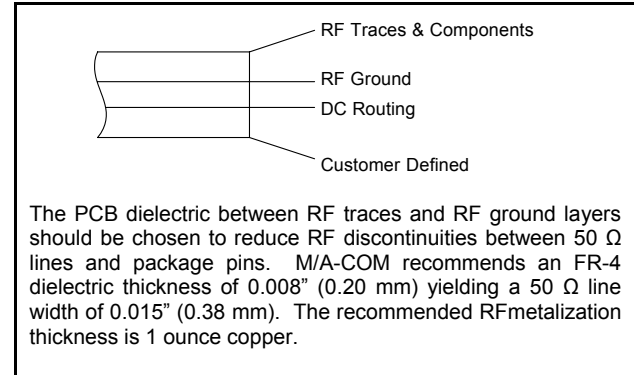

Designer's Kit AM50-0003SMB

The AM50-0003SMB Designer's Kit allows for immediate evaluation of M/A-COM's AM50-0003. The Designer's Kit includes an evaluation board with mounted AM50-0003 and five loose AM50-0003's. The evaluation board consists of the recommended external surface mount circuitry, RF connectors, and a DC multi-pin connector, all mounted to a multi-layer FR-4 PCB. The AM50-0003SMB evaluation PCB is illustrated below with all functional ports labeled.

AM50-0003 Evaluation Board

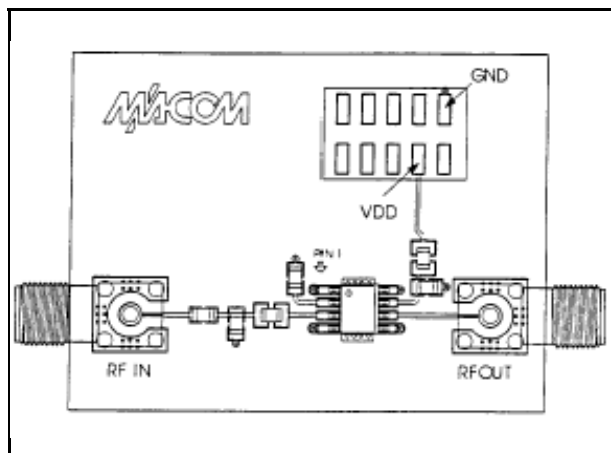

Evaluation PCB & RF Connector Losses

Port Reference	Approximate RF Loss
LNA Input	0.1 dB @ 900 MHz
LNA Output	0.1 dB @ 900 MHz

The DC connector on the Designer's Kit PCB allows convenient DC line access. This is accomplished by the one or more of the following methods.

7. A mating female multi-pin connector (newark Electronics Stock # 46F-4658, not included).
8. Wires soldered to the necessary pins (not included).
9. Clip leads (not included).

Typical Performance Curves

Gain vs. Frequency

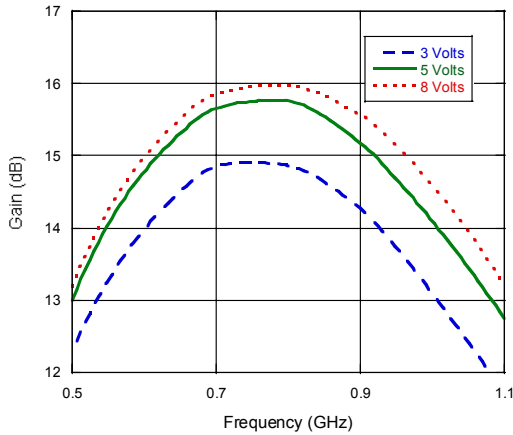

VSWR vs. Frequency

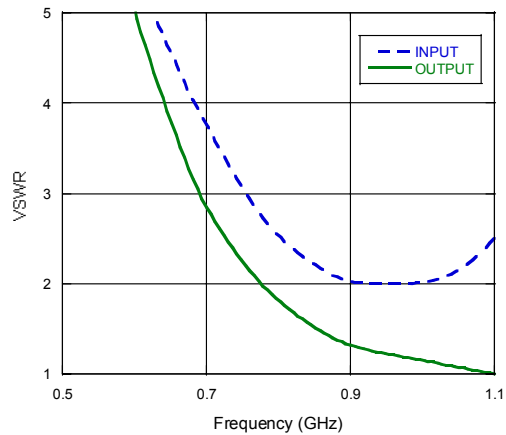

Noise Figure vs. Frequency

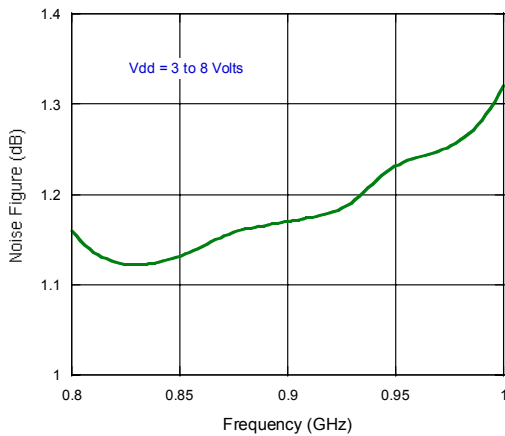

Noise Figure vs. Current, F = 900 MHz

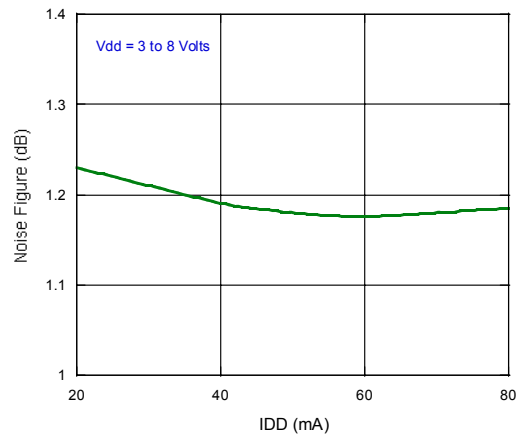

Output P1 dB vs. Frequency

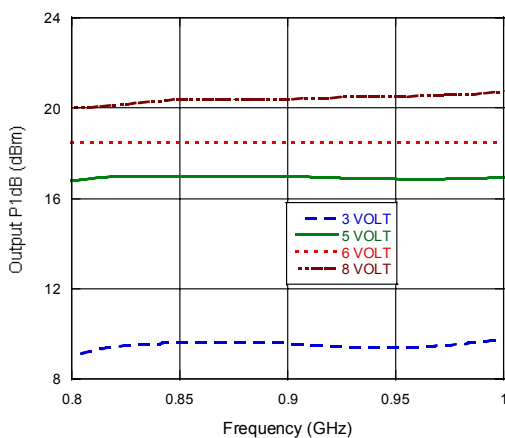

Output P1 dB vs. Current, F = 900 MHz

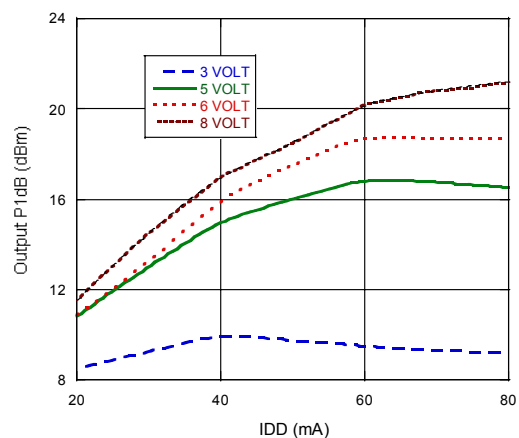

**High Dynamic Range Low Noise Amplifier,
800 - 1000 MHz**

**AM50-0003
V3**

Typical Performance Curves

Input IP3 vs. Frequency

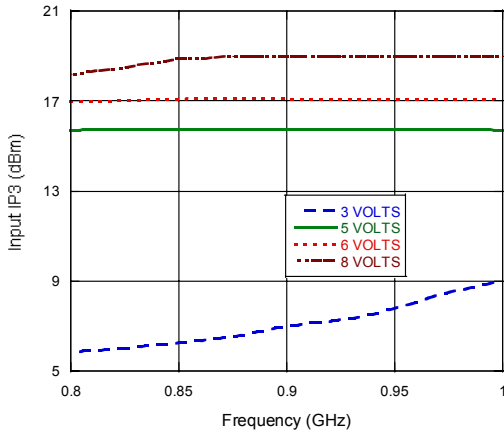

Input IP3 vs. Current, F = 900 MHz

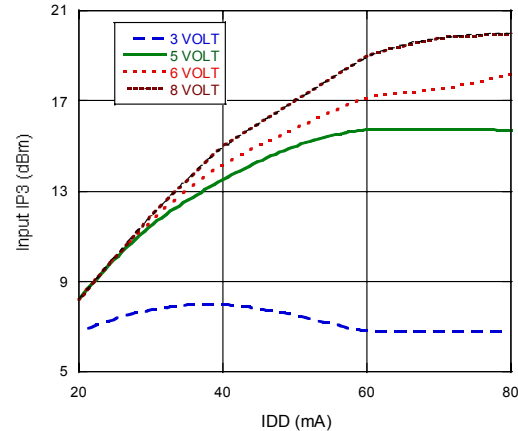

SOIC-8

The drawing shows the top and side views of the SOIC-8 package. Key markings include: PART NUMBER (XX-XXX), DATE/LOT CODE (YYWWXXXX), COMPANY LOGO (MACOM), ORIENTATION MARK, and COUNTRY CODE (XXXXXXXX). Dimensions are provided in inches and millimeters. Pin 1 and Pin 8 are indicated. A note specifies 8X for the lead length.

NOTES:
 1. REFERENCE JEDEC MS-012-AA, FOR ADDITIONAL DIMENSIONAL AND TOLERANCE INFORMATION.
 2. REFERENCE M538 APPLICATION NOTE FOR FOOTPRINT INFORMATION.
 3. ALL DIMENSIONS SHOWN AS INCHES/MM.

The AM50-0003 is fabricated using a low-cost 0.5-micron gate length GaAs process. The process features full passivation for increased performance reliability. The AM50-0003 is 100% RF tested to ensure performance specification compliance.