

SHINDENGEN

Schottky Rectifiers (SBD)

Single

M1FS4

40V 1.33A

FEATURES

- Small SMT
- Tj150
- Low $V_F=0.45V$
- P_{RRSM} avalanche guaranteed

APPLICATION

- Switching power supply
- DC/DC converter
- Home Appliances, Office Equipment
- Telecommunication

OUTLINE DIMENSIONS

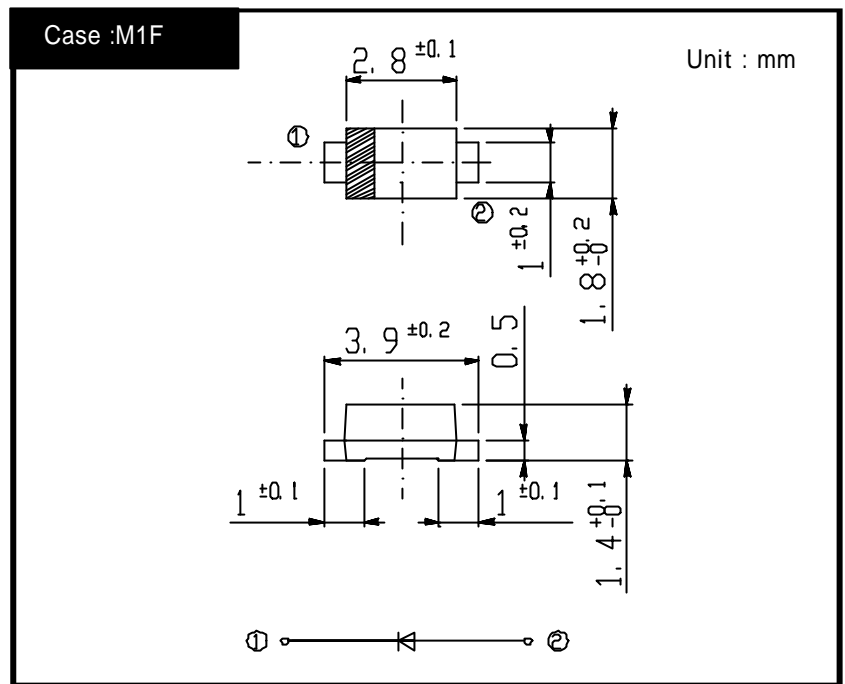

RATINGS

Absolute Maximum Ratings (If not specified Tl=25)

Item	Symbol	Conditions	Ratings	Unit
Storage Temperature	Tstg		-55 ~ 150	
Operating Junction Temperature	Tj		150	
Maximum Reverse Voltage	V_{RM}		40	V
Repetitive Peak Surge Reverse Voltage	V_{RRSM}	Pulse width 0.5ms, duty 1/40	45	V
Average Rectified Forward Current	Io	50Hz sine wave, R-load Ta=25 On alumina substrate	1.33	A
		50Hz sine wave, R-load Ta=25 On glass-epoxy substrate	0.87	
Peak Surge Forward Current	I_{FSM}	50Hz sine wave, Non-repetitive 1 cycle peak value, Tj=25	30	A
Repetitive Peak Surge Reverse Power	P_{RRSM}	Pulse width 10 μ s, Tj=25	60	W

Electrical Characteristics (If not specified Tl=25)

Item	Symbol	Conditions	Ratings	Unit
Forward Voltage	V_F	$I_F=1.1A$, Pulse measurement	Max.0.55	V
Reverse Current	I_R	$V_R=10V$, Pulse measurement	Max.0.8	mA
Junction Capacitance	Cj	f=1MHz, $V_R=10V$	Typ.50	pF
Thermal Resistance	j	junction to lead	Max.20	/W
		junction to ambient On alumina substrate	Max.108	
		junction to ambient On glass-epoxy substrate	Max.186	

M1FS4

Forward Voltage

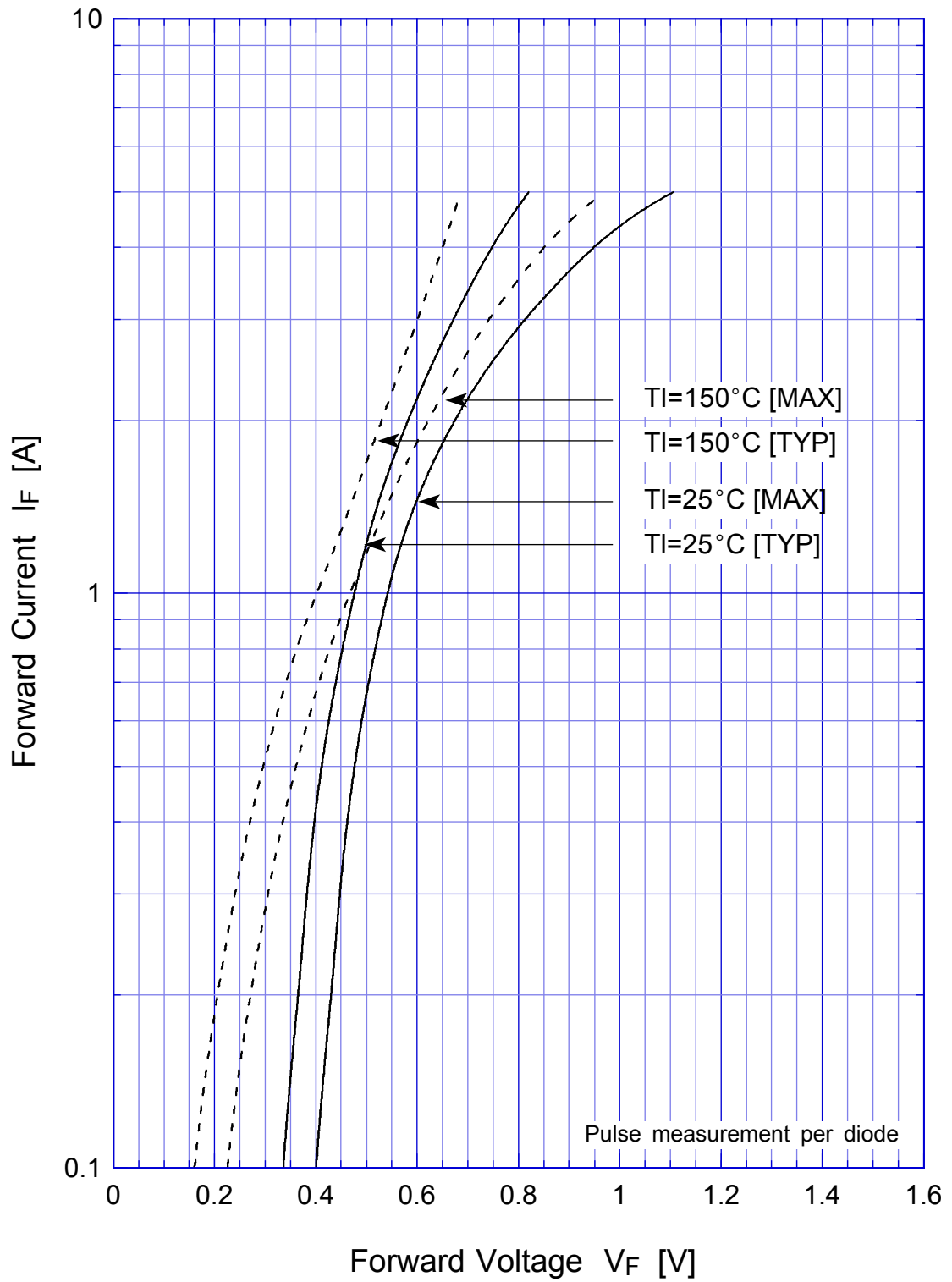

M1FS4

Junction Capacitance

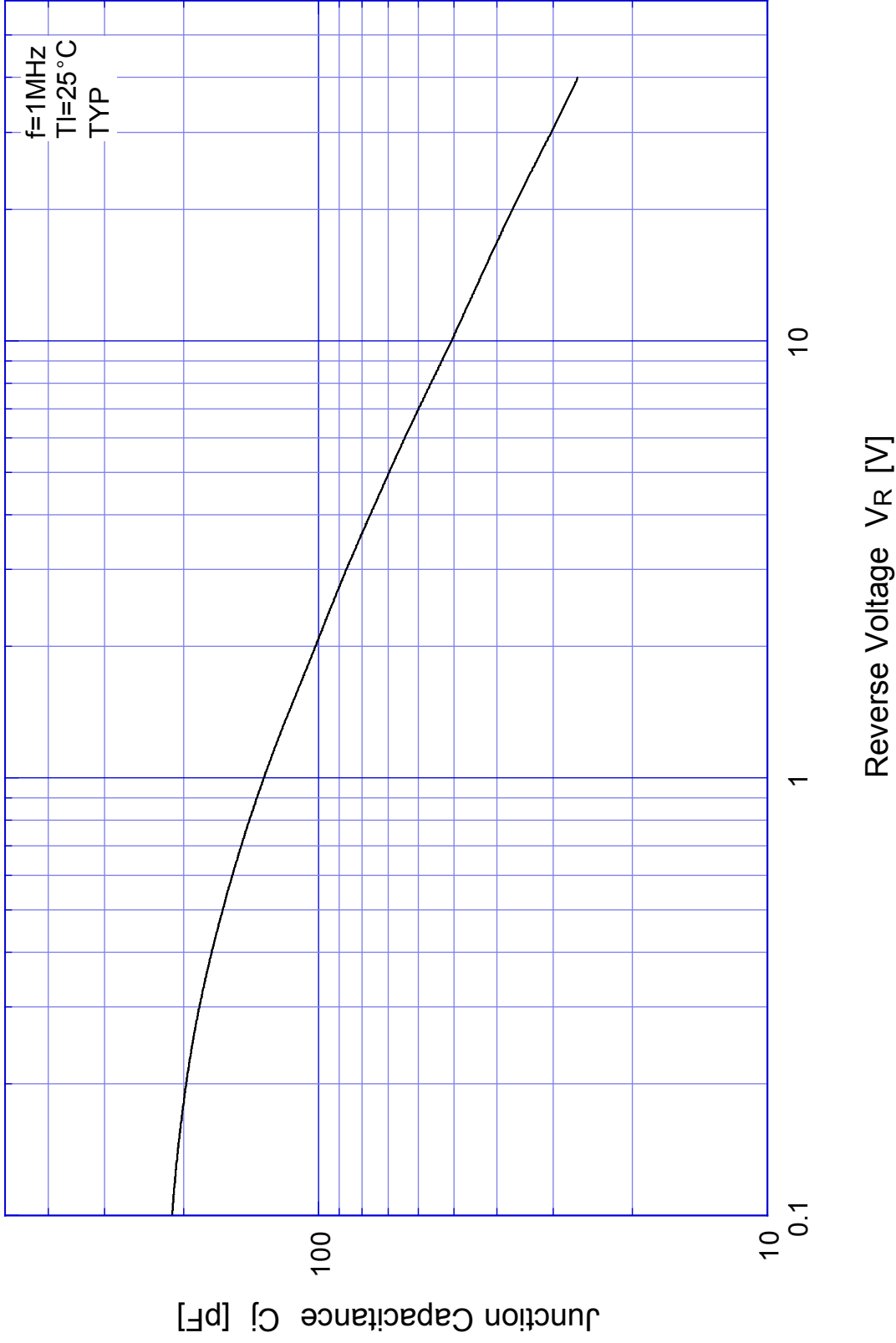

M1FS4

Reverse Current

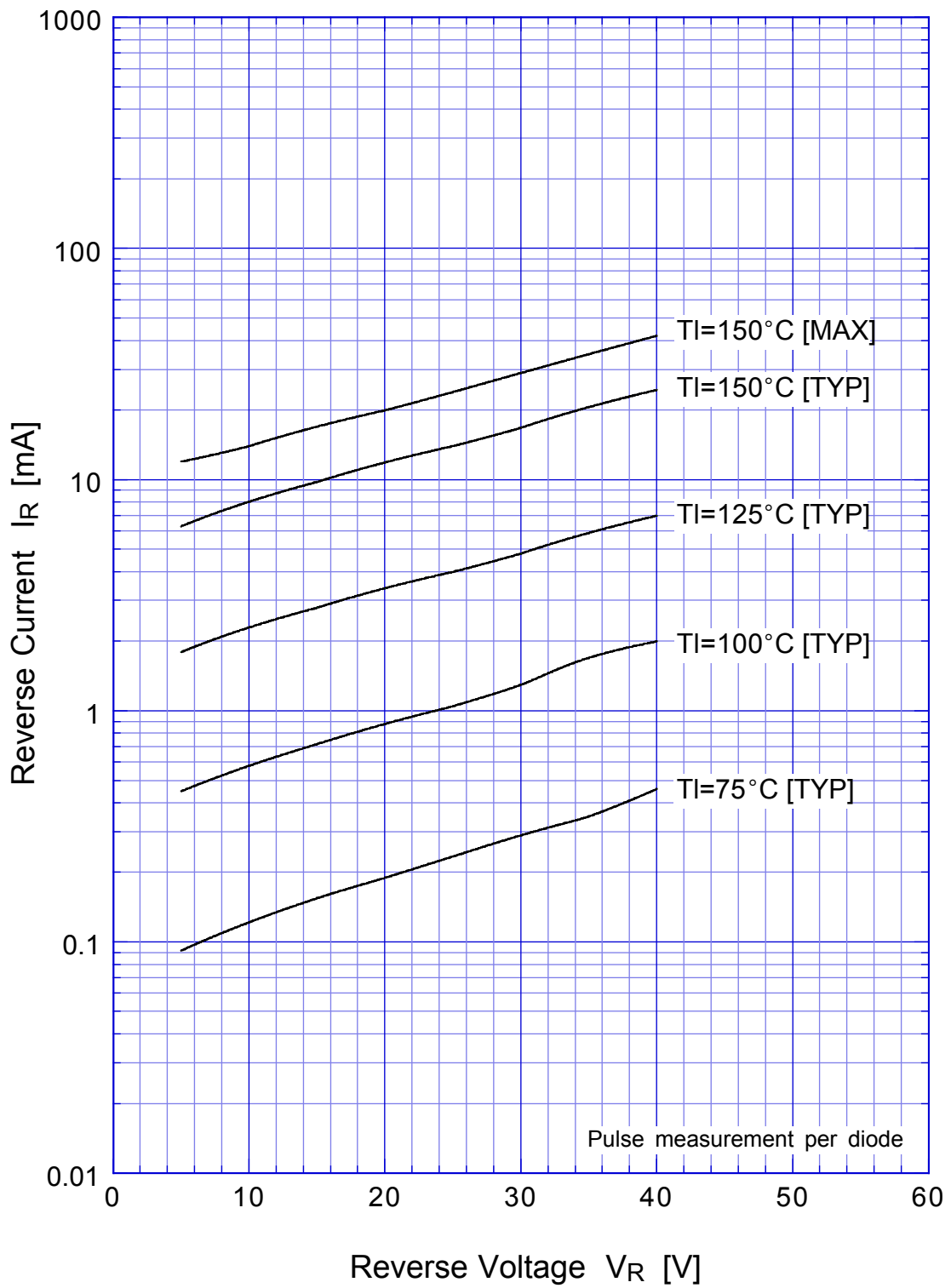

M1FS4

Reverse Power Dissipation

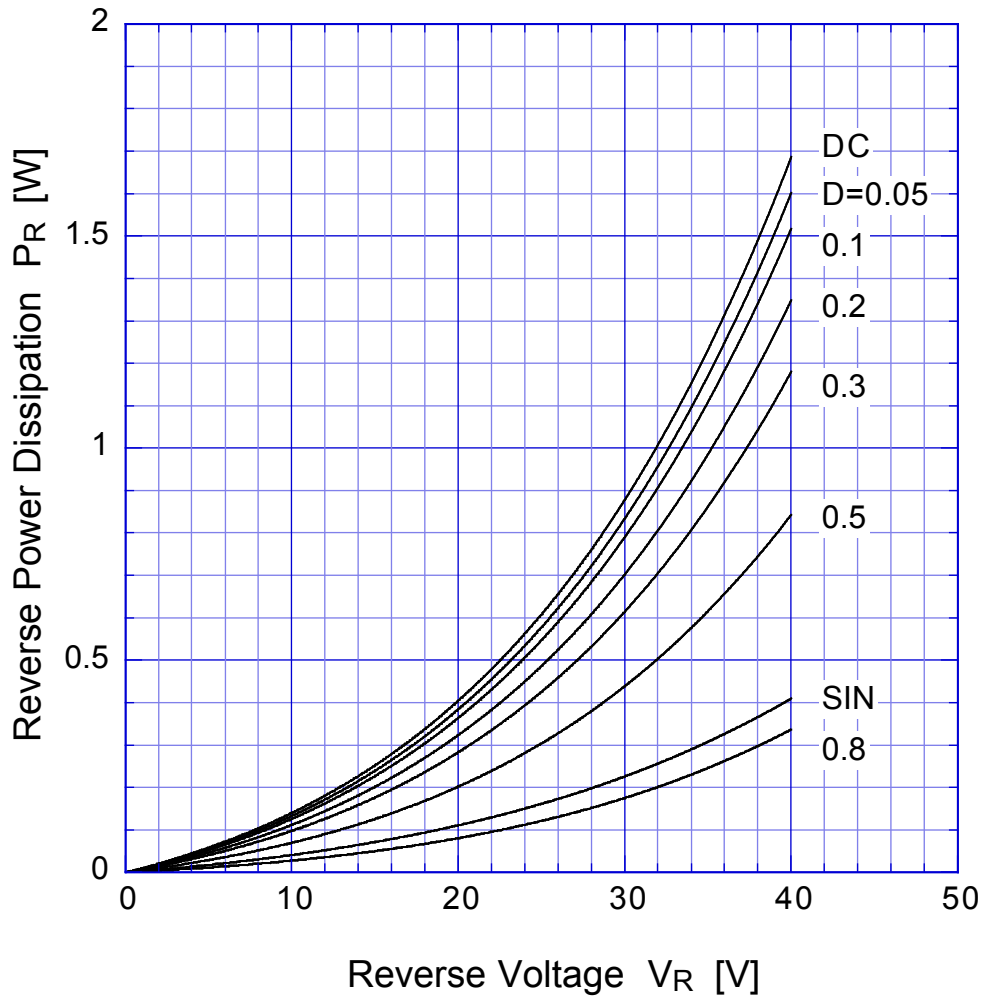

$T_j = 150^\circ\text{C}$

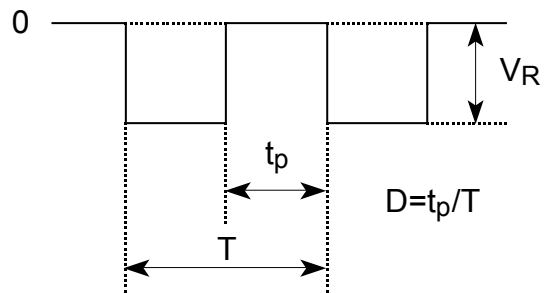

M1FS4

Forward Power Dissipation

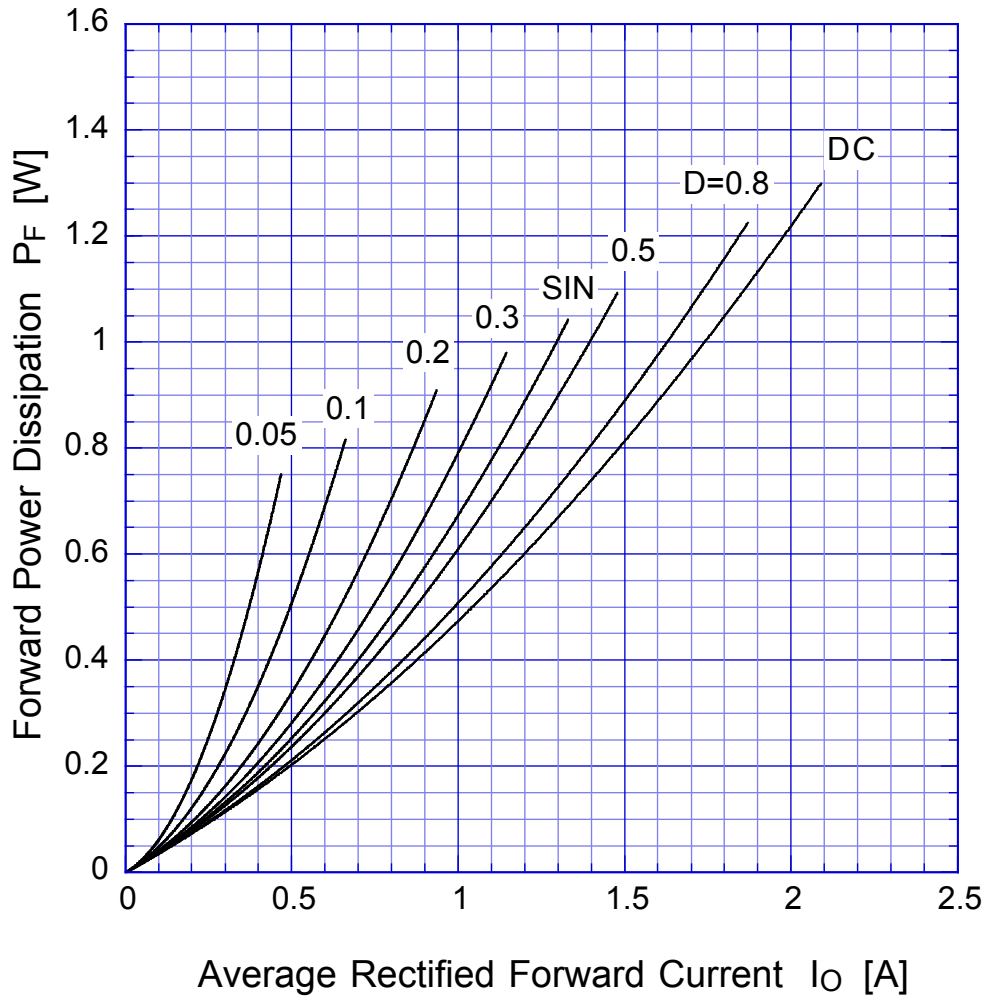

$T_j = 150^\circ\text{C}$

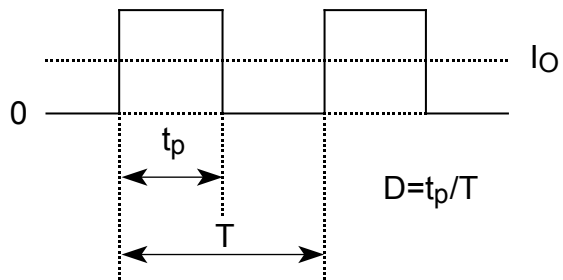

M1FS4

Derating Curve

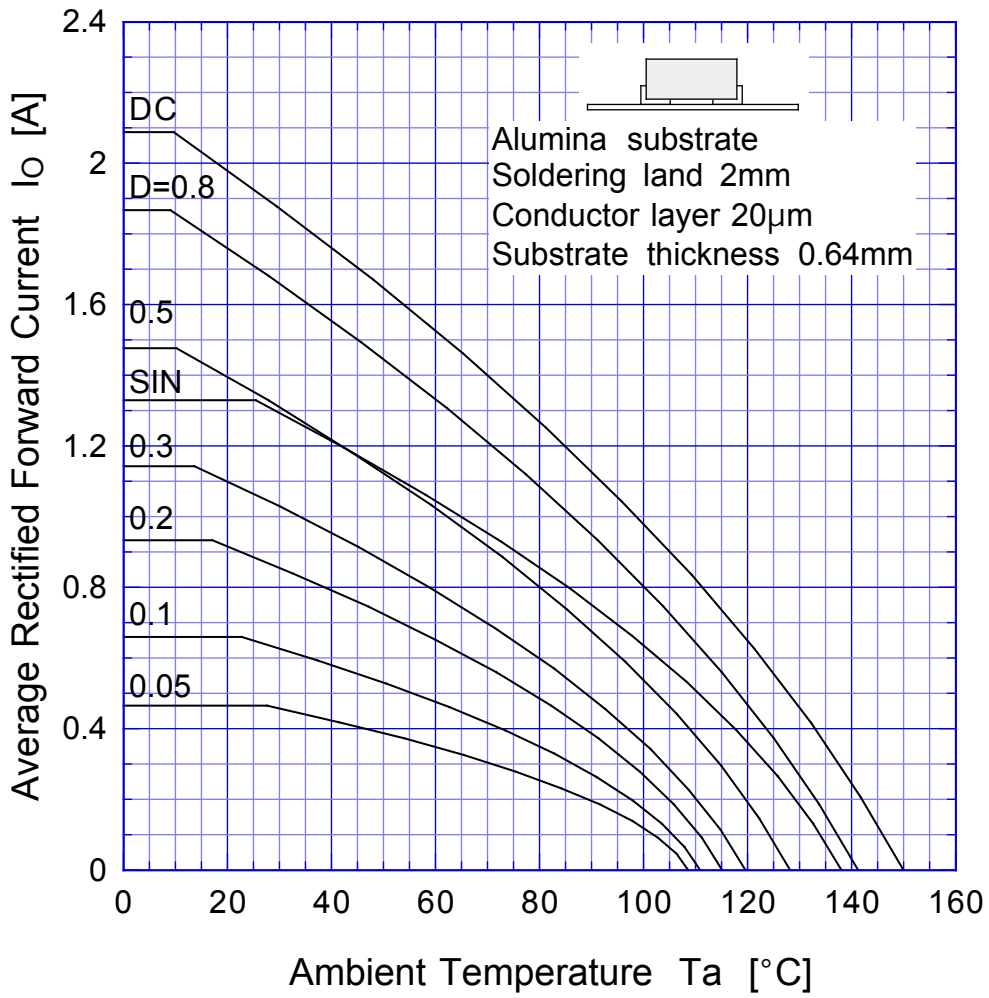

$V_R = 20V$

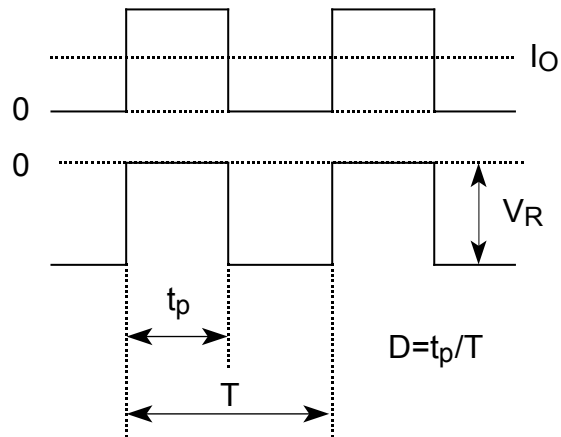

M1FS4

Derating Curve

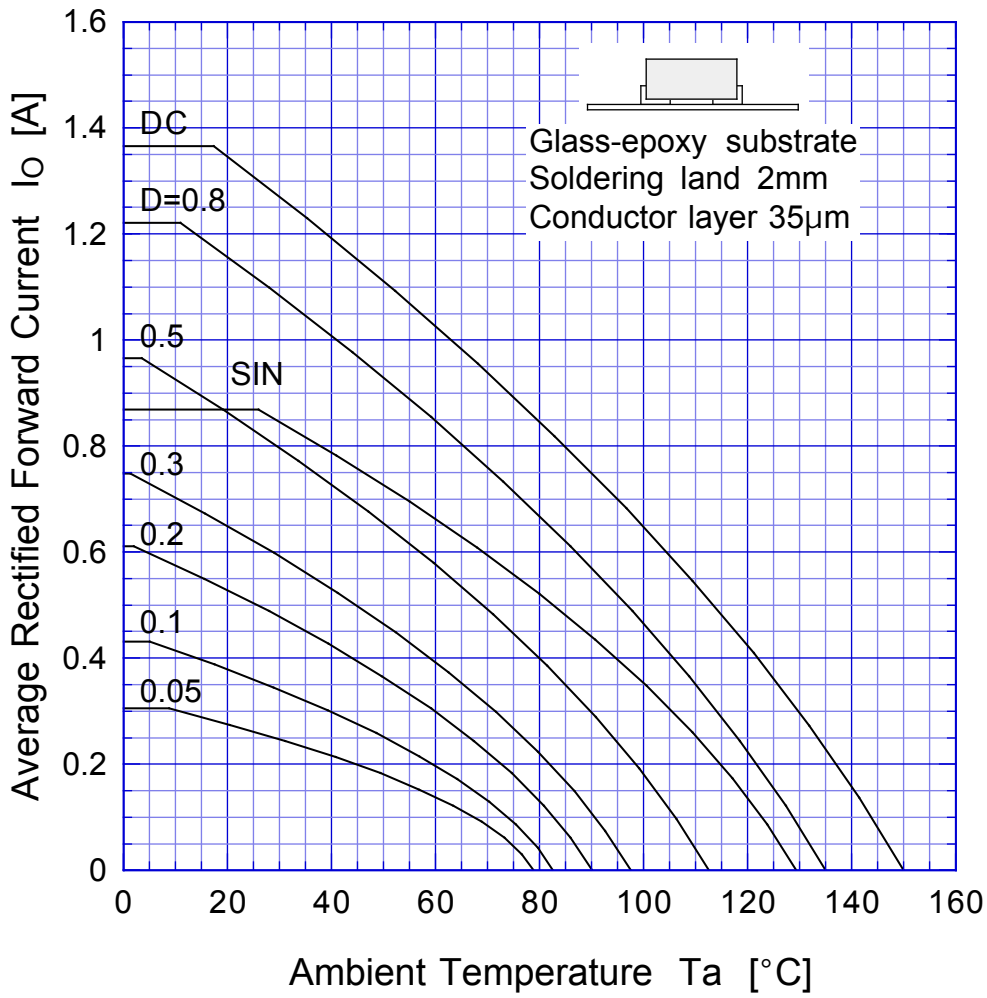

$V_R = 20V$

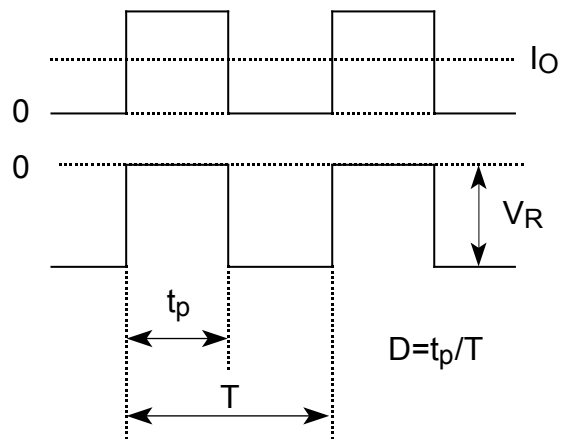

M1FS4

Peak Surge Forward Capability

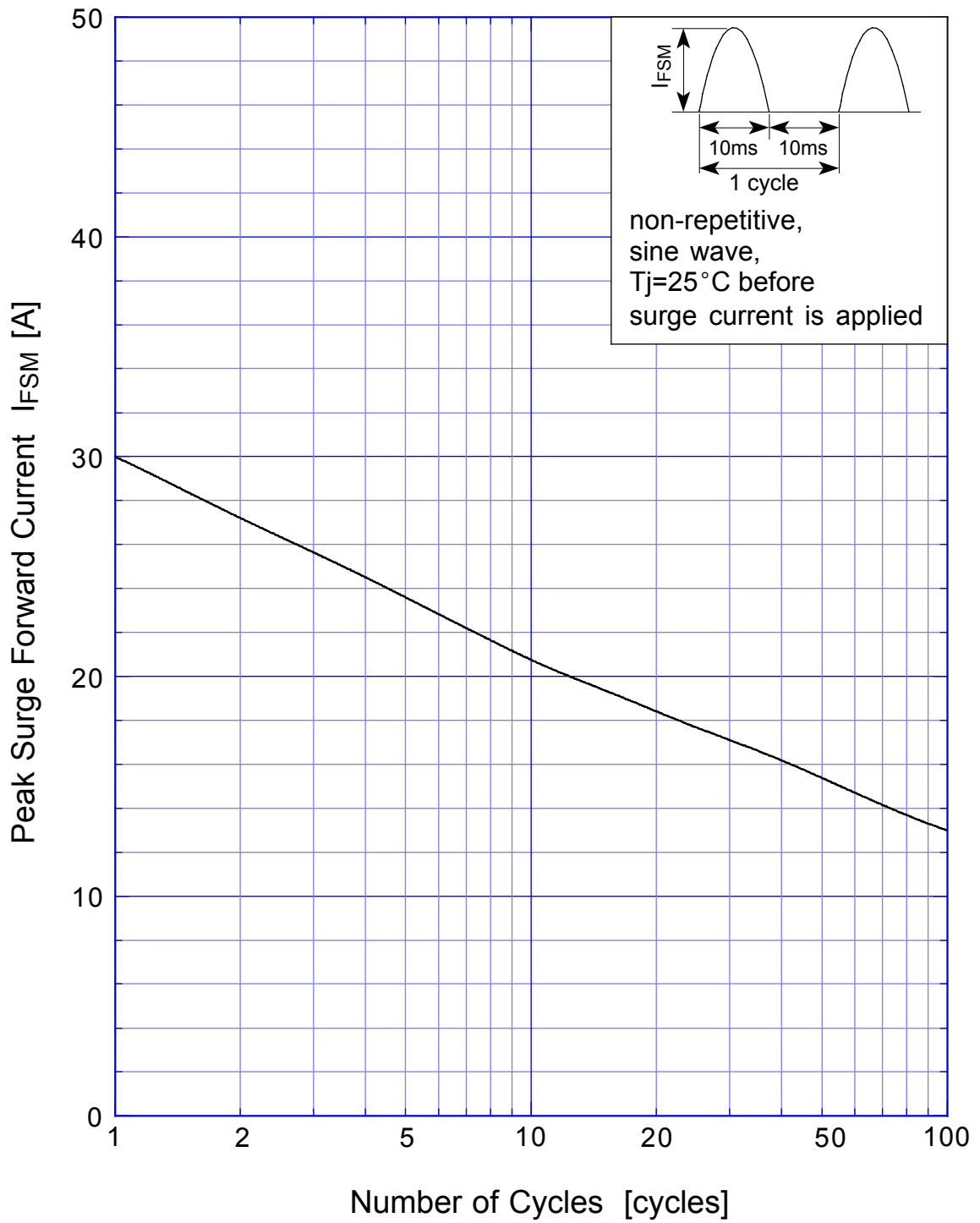

SBD Repetitive Surge Reverse Power Derating Curve

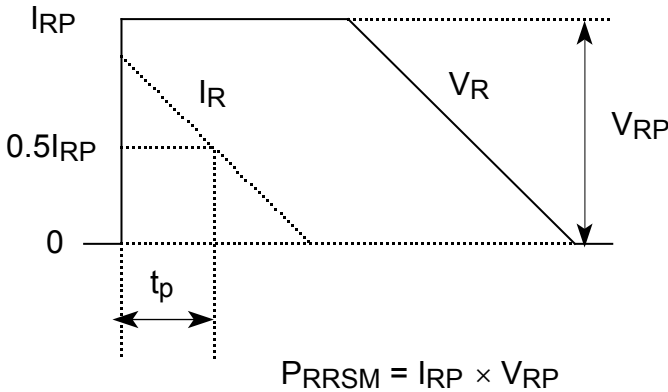
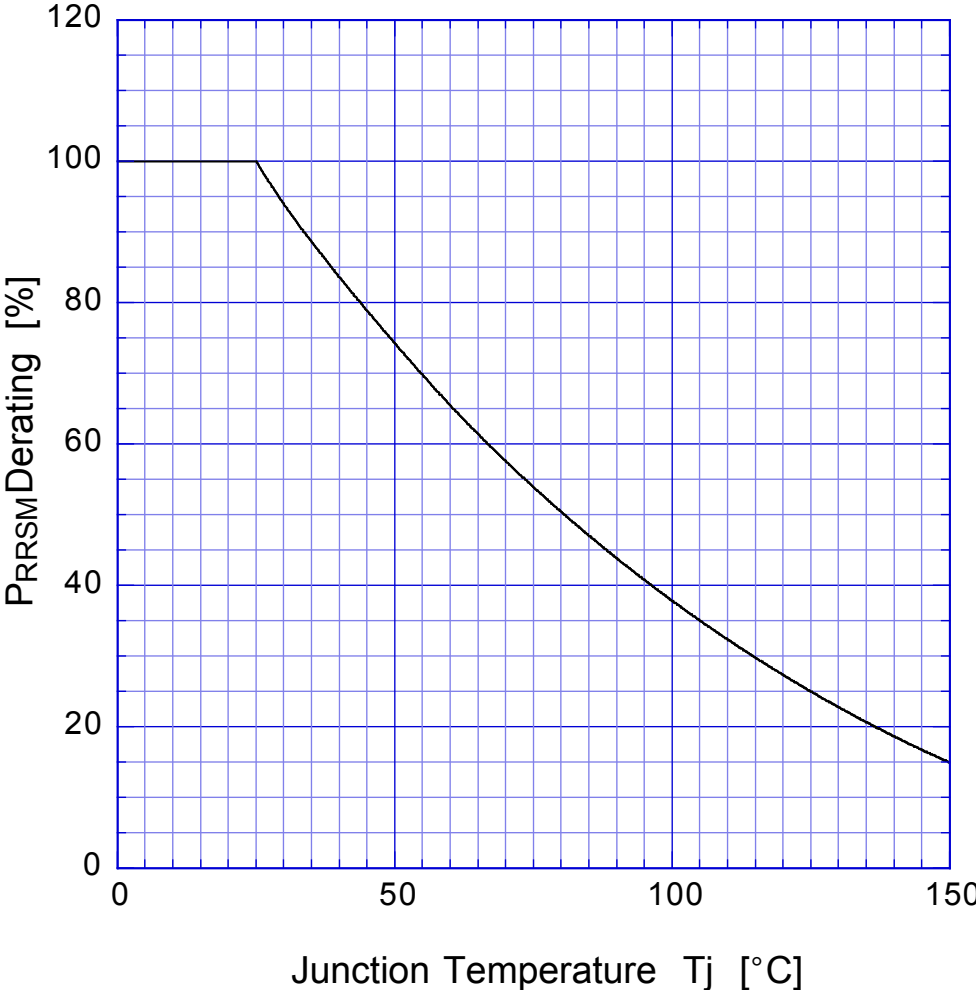

SBD

Repetitive Surge Reverse Power Capability

