

### Features

- Fast Switching Speed
- Ultra-Small Surface Mount Package
- For General Purpose Switching Applications
- High Conductance
- **Lead Free/RoHS Compliant (Note 4)**
- **"Green" Device (Note 5 and 6)**

### Mechanical Data

- Case: SOT-26
- Case Material: Molded Plastic, "Green" Molding Compound, Note 6. UL Flammability Classification 94V-0
- Moisture Sensitivity: Level 1 per J-STD-020C
- Terminals: Solderable per MIL-STD-202, Method 208
- Lead Free Plating (Matte Tin Finish annealed over Copper leadframe).
- Polarity: See Diagram
- Marking: KLG, See Page 2
- Ordering Information: See Below
- Weight: 0.016 grams (approximate)

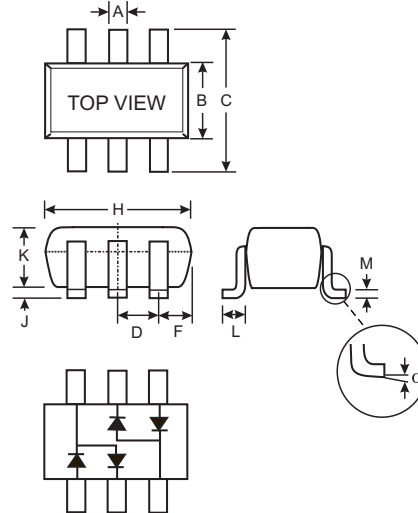

SOT-26			
Dim	Min	Max	Typ
A	0.35	0.50	0.38
B	1.50	1.70	1.60
C	2.70	3.00	2.80
D	—	—	0.95
F	—	—	0.55
H	2.90	3.10	3.00
J	0.013	0.10	0.05
K	1.00	1.30	1.10
L	0.35	0.55	0.40
M	0.10	0.20	0.15
$\alpha$	0°	8°	—
All Dimensions in mm			

### Maximum Ratings @ $T_A = 25^\circ\text{C}$ unless otherwise specified

Characteristic	Symbol	Value	Unit
Peak Repetitive Reverse Voltage Working Peak Reverse Voltage DC Blocking Voltage	$V_{RRM}$ $V_{RWM}$ $V_R$	45	V
RMS Reverse Voltage	$V_{R(RMS)}$	40	V
Forward Continuous Current (Note 1)	$I_{FM}$	100	mA
Forward Surge Current @ $t < 8.3\text{ms}$	$I_{FSM}$	1.0	A
Power Dissipation (Note 1)	$P_d$	225	mW
Thermal Resistance Junction to Ambient Air (Note 1)	$R_{\theta JA}$	444	$^\circ\text{C}/\text{W}$
Operating and Storage Temperature Range	$T_j, T_{STG}$	-40 to +125	$^\circ\text{C}$

### Electrical Characteristics @ $T_A = 25^\circ\text{C}$ unless otherwise specified

Characteristic	Symbol	Min	Typ	Max	Unit	Test Condition
Reverse Breakdown Voltage (Note 2)	$V_{(BR)R}$	45	—	—	—	$I_R = 100\mu\text{A}$
Forward Voltage	$V_F$	—	370	450	mV	$I_F = 10\text{mA}$
Reverse Leakage Current (Note 2)	$I_R$	—	0.07	1.0	$\mu\text{A}$	$V_R = 10\text{V}$
Total Capacitance	$C_T$	—	6.0	—	pF	$V_R = 10\text{V}, f = 1.0\text{MHz}$

### Ordering Information (Note 3 & 6)

Device	Packaging	Shipping
SDM10M45SD-7-F	SOT-26	3000/Tape & Reel

- Note:
1. Device mounted on FR-5 PCB 1.0 x 0.75 x 0.062 inch pad layout as shown on Diodes, Inc. suggested pad layout AP02001, which can be found on our website at <http://www.diodes.com/datasheets/ap02001.pdf>.
  2. Short duration pulse test to minimize self-heating effect.
  3. For packaging details, go to our website at <http://www.diodes.com/datasheets/ap02007.pdf>.
  4. No purposefully added lead.
  5. Diodes Inc.'s "Green" policy can be found on our website at [http://www.diodes.com/products/lead\\_free/index.php](http://www.diodes.com/products/lead_free/index.php).
  6. Product manufactured with Date Code 0609 (week 9, 2006) and newer are built with Green Molding Compound. Product manufactured prior to Date Code 0609 are built with Non-Green Molding Compound and may contain Halogens or Sb2O3 Fire Retardants.

**Marking Information**

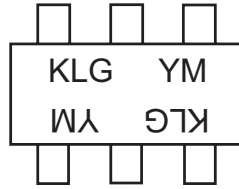

KLG = Product Type Marking Code  
 YM = Date Code Marking  
 Y = Year ex: P = 2003  
 M = Month ex: 9 = September

Date Code Key

Year	2003	2004	2005	2006	2007	2008	2009	2010	2011	2012
Code	P	R	S	T	U	V	W	X	Y	Z

Month	Jan	Feb	March	Apr	May	Jun	Jul	Aug	Sep	Oct	Nov	Dec
Code	1	2	3	4	5	6	7	8	9	O	N	D

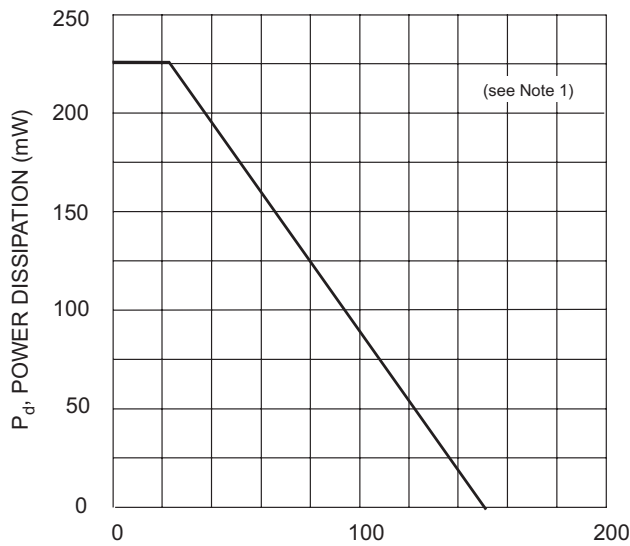

$T_A$ , AMBIENT TEMPERATURE (°C)  
 Fig. 1, Power Derating Curve

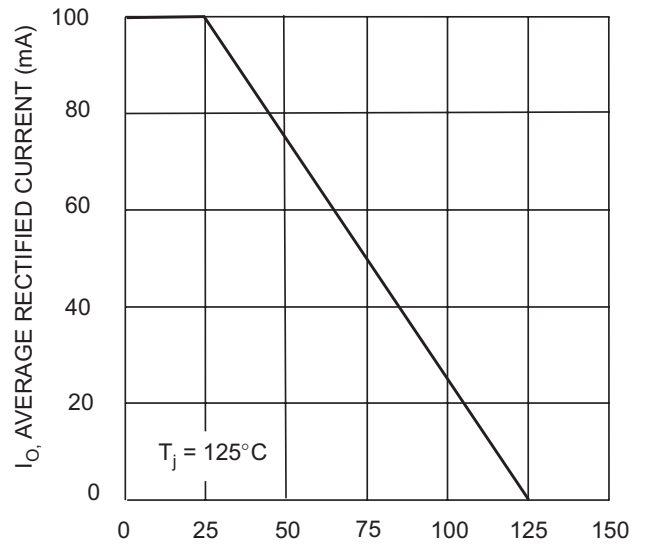

$T_A$ , AMBIENT TEMPERATURE (°C)  
 Fig. 2 Forward Current Derating Curve (Per Element)

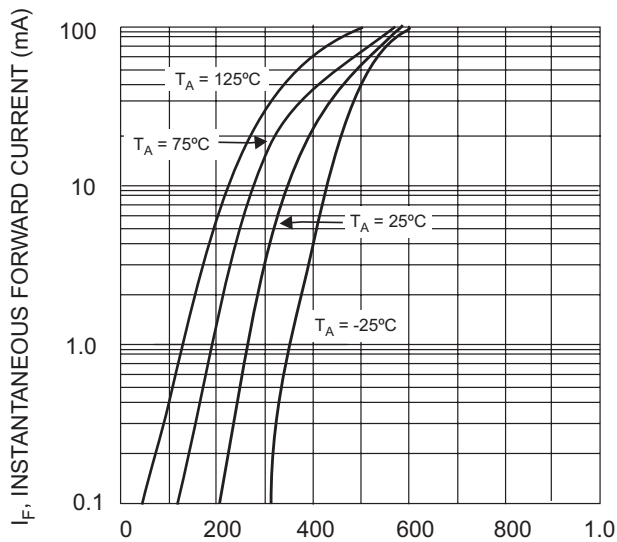

$V_F$ , INSTANTANEOUS FORWARD VOLTAGE (V)  
 Fig. 3 Typical Forward Characteristics

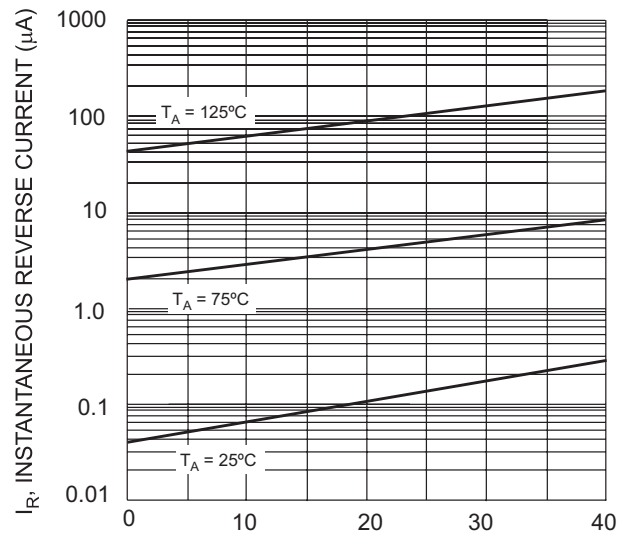

$V_R$ , INSTANTANEOUS REVERSE VOLTAGE (V)  
 Fig. 4 Typical Reverse Characteristics

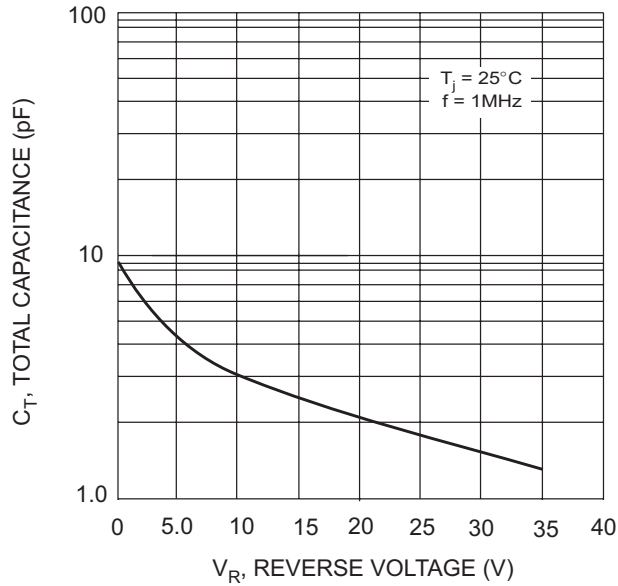

Fig. 5 Total Capacitance vs. Reverse Voltage, Per Element

**IMPORTANT NOTICE**

Diodes Incorporated and its subsidiaries reserve the right to make modifications, enhancements, improvements, corrections or other changes without further notice to any product herein. Diodes Incorporated does not assume any liability arising out of the application or use of any product described herein; neither does it convey any license under its patent rights, nor the rights of others. The user of products in such applications shall assume all risks of such use and will agree to hold Diodes Incorporated and all the companies whose products are represented on our website, harmless against all damages.

**LIFE SUPPORT**

Diodes Incorporated products are not authorized for use as critical components in life support devices or systems without the expressed written approval of the President of Diodes Incorporated.