

- ◆ **CMOS Low Power Consumption** 70 μ A
- ◆ **Maximum Output Current** : 150mA
- ◆ **Highly Accurate** : $\pm 2\%$ (± 30 mV less than 1.5V)
- ◆ **Output Voltage Range** : 0.9V ~ 1.75V (50mV Step)
- ◆ **High Ripple Rejection** : 60dB
- ◆ **Low Noise** : 30 μ Vrms
- ◆ **Low ESR capacitor compatible**

General Description

The XC6205 series are highly precise, low noise, positive voltage LDO regulators manufactured using CMOS processes. The series achieves high ripple rejection and low dropout and consists of a voltage reference, an error amplifier, a current limiter and a phase compensation circuit plus a driver transistor. Output voltage is selectable in 50mV increments within a range of 0.9V ~ 1.75V.

The series is also compatible with low ESR ceramic capacitors which give added output stability. This stability can be maintained even during load fluctuations due to the excellent transient response of the series.

The current limiter's foldback circuit also operates as a short protect for the output current limiter and the output pin. The CE function enables the output to be turned off, resulting in greatly reduced power consumption.

Typical Application

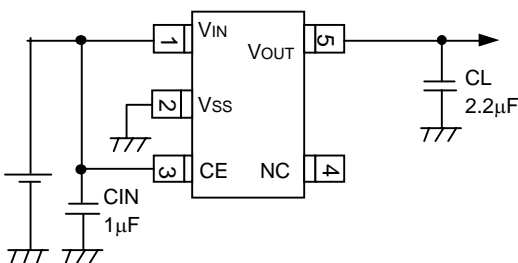

Applications

- Mobile phones, Cordless phones
- Wireless communication equipment
- Portable games
- Cameras, Video recorders
- Portable AV equipment
- Reference voltage
- Battery powered equipment

Features

Maximum Output Current	: 150mA
Maximum Operating Voltage	: 2.0V ~ 10V
Output Voltage Range	: 0.9V~1.75V(50mV Step)
Highly Accurate	: $\pm 2\%$ ($V_{OUT} > 1.5V$)
	: ± 30 mV ($V_{OUT} \leq 1.5V$)
Low Power Consumption	: TYP 70 μ A
Standby Current	: Less than 0.1 μ A (TYP)
Low Noise	: 30 μ Vrms (TYP)
High Ripple Rejection	: 60dB (10kHz)
Operating Temperature Range	: -40°C ~ +85°C
Low ESR Capacitor Compatible	: Ceramic capacitor
Ultra Small Packages	: SOT-25 (SOT-23-5)
	SOT-89-5
	USP-6B

Electrical Characteristics

- Load Transient Response

XC6205B092

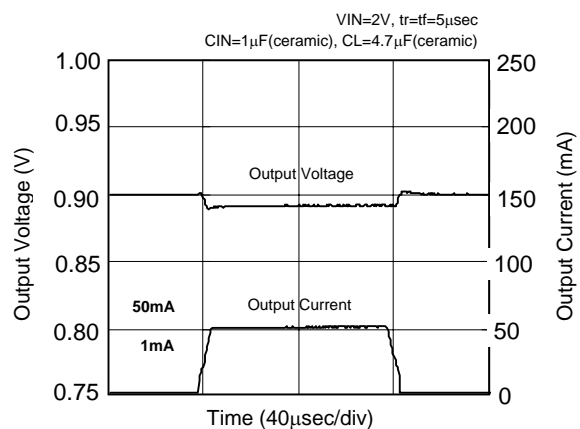

Pin Assignment

PIN NUMBER			PIN NAME	FUNCTION
SOT-25	SOT-89-5	USP-6B		
1	4	1	VIN	Input
2	2	5	VSS	Ground
3	3	6	CE	ON/OFF Control
4	1	2, 4	NC	No Connection
5	5	3	VOUT	Output

Pin Configuration

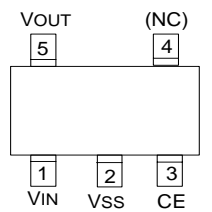

SOT-25 (SOT-23-5)
(TOP VIEW)

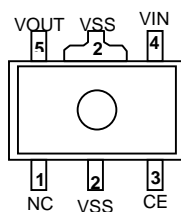

SOT-89-5
(TOP VIEW)

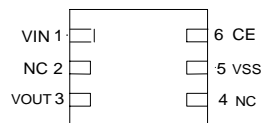

USP-6B
(TOP VIEW)

Block Diagram

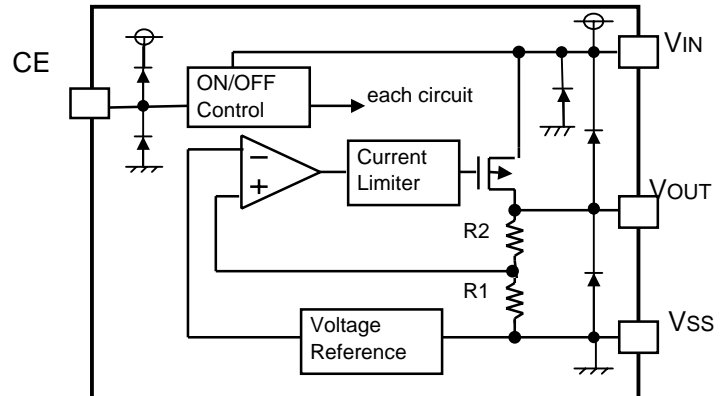

* The diode in the above diagram is for the IC's protection.

Selection Guide

The following options for the CE pin logic and internal pull-up/down are available:

- Active 'High' + no pull-down resistor built-in (standard)
- Active 'High' + 300MΩ pull-down resistor built-in <between CE-VSS> (semi-custom)
- Active 'Low' + no pull-up resistor built-in (semi-custom)
- Active 'Low' + 300MΩ pull-up resistor built-in <between VIN-CE> (semi-custom)

Note: *With the pull-up resistor or pull-down resistor built-in types, the supply current during operation will increase by $V_{IN} / 300M\Omega$ (TYP.).

Ordering Information

XC6205①②③④⑤⑥

DESIGNATOR	SYMBOL	DESCRIPTION	DESIGNATOR	SYMBOL	DESCRIPTION
①	A	Active 'High' (pull-down resistor built in)	④	2	Output Voltage : 100mV Step Accuracy : within ±2% e.g. ②=0, ③=9, ④=2 ⇒ 0.9V
	B	Active 'High' (no pull-down resistor built in)		A	Output Voltage : 50mV Step Accuracy : within ±2% e.g. ②=1, ③=3, ④=A ⇒ 1.35V
	C	Active 'Low' (pull-up resistor built in)		⑤	M
	D	Active 'Low' (no pull-up resistor built in)	D		USP - 6B
② ③	Integer	Output Voltage : e.g. 1.5V = ② : 1, ③ : 5	⑥		Device Orientation :
				R	Embossed Tape : Standard Feed
				L	Embossed Tape : Reverse Feed

■ Absolute Maximum Rating

PARAMETER		SYMBOL	RATINGS	UNITS
Input Voltage		VIN	12	V
Output Current		IOUT	500	mA
Output Voltage		VOUT	VSS -0.3 ~ VIN +0.3	V
CE Input Voltage		VCE	VSS -0.3 ~ VIN +0.3	V
Power Dissipation	SOT-25(SOT-23-5)	Pd	250	mW
	USP-6B		100	
Operating Ambient Temperature		Topr	-40 ~ +85	°C
Storage Temperature		Tstg	-55 ~ +125	°C

■ Electrical Characteristics XC6205x152 (1.5V)

Ta=25°C

PARAMETER	SYMBOL	CONDITIONS	MIN	TYP	MAX	UNITS	CIRCUIT
Output Voltage	VOUT (E)	IOUT=30mA	× 0.98 1.470	VOUT(T) 1.500	× 1.02 1.530	V	1
Maximum Output Current	IOUTMAX		150			mA	1
Load Regulation	ΔVOUT	1mA ≤ IOUT ≤ 100mA		15	50	mV	1
Dropout Voltage	Vdif1	IOUT=30mA		500		mV	1
	Vdif2	IOUT=100mA		600		mV	
Supply Current	IDD	VCE=VIN		70		μA	2
Standby Current	Istby	VCE=VSS		0.01	0.10	μA	2
Line Regulation	ΔVOUT / ΔVIN · VOUT	VOUT(T)+1.0V ≤ VIN ≤ 10V IOUT=30mA		0.01	0.20	% / V	1
Input Voltage	VIN		2.0		10.0	V	-
Output Voltage Temperature Characteristics	ΔVOUT / ΔTopr · VOUT	IOUT=30mA -40°C ≤ Topr ≤ 85°C		100		ppm/°C	1
Ripple Rejection Rate	PSRR	IOUT=50mA, f=10kHz		60		dB	4
Output Noise	en	300Hz ~ 50kHz		30		μVrms	3
Current Limiter	Ilim			300		mA	1
Short-circuit Current	Ishort	VIN=VOUT+1.5V, VOUT=VSS		50		mA	1
CE "High" Voltage	VCEH		1.60		VIN	V	2
CE "Low" Voltage	VCEL				0.25	V	2
CE "High" Current	ICEH	VCE=VIN	-0.10		0.10	μA	2
CE "Low" Current	ICEL	VCE=VSS	-0.10		0.10	μA	2

NOTE

(NOTE 1) VOUT(T)=Specified Output Voltage

(NOTE 2) VOUT(E)=Effective Output Voltage

(I.e. the output voltage when "VOUT(T)+1.0V" is provided at the VIN pin while maintaining a certain IOUT value).

(NOTE 3) $V_{dif} = \{V_{IN1}^{(NOTE5)} - V_{OUT1}^{(NOTE4)}\}$

(NOTE 4) VOUT 1 = A voltage equal to 98% of the Output Voltage whenever an amply stabilized IOUT (VOUT(T) + 1.0V) is input.

(NOTE 5) VIN1=The Input Voltage when VOUT1 appears as Input Voltage is gradually decreased.

(NOTE 6) Unless otherwise stated, VIN=VOUT(T)+1.0V

■ Test Circuits

Circuit 1

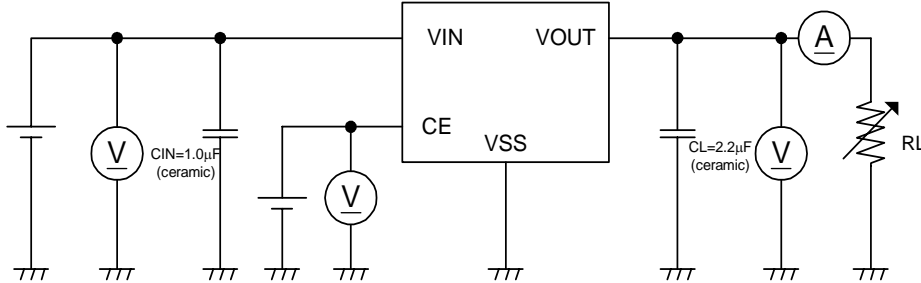

Circuit 2

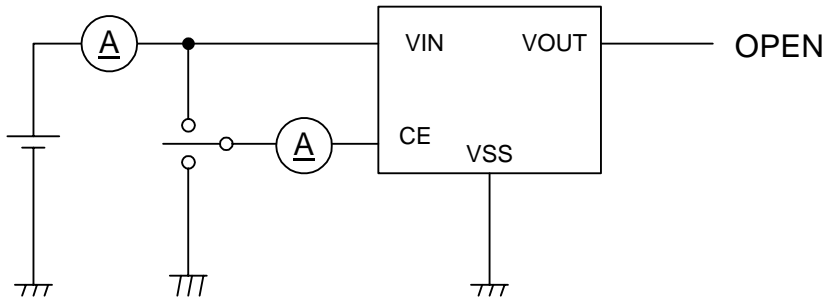

Circuit 3

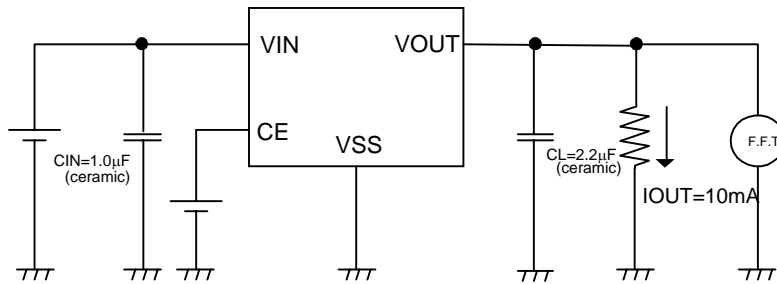

Circuit 4

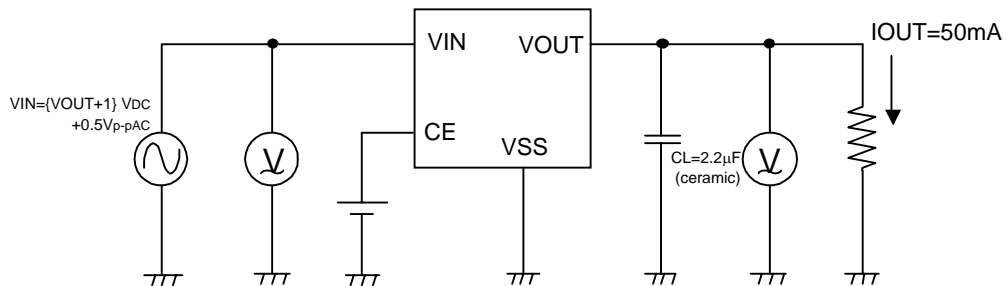

Operational Explanation

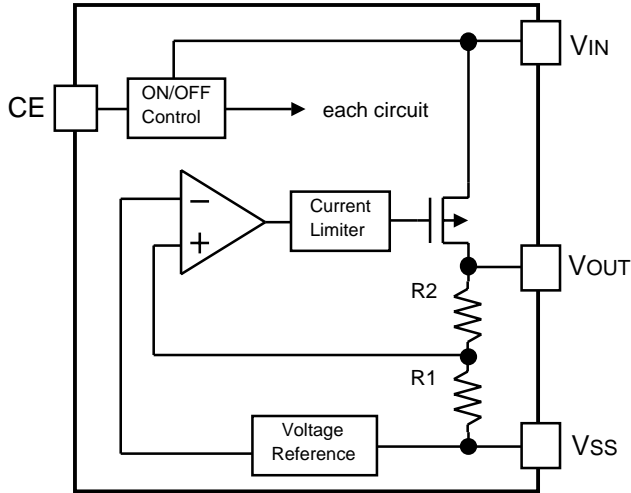

Output voltage control with the XC6205 series :

The voltage divided by resistors R1 & R2 is compared with the internal reference voltage by the error amplifier.

The P-Channel MOSFET, which is connected to the VOUT pin, is then driven by the subsequent output signal. The output voltage at the VOUT pin is controlled & stabilized by a system of negative feedback.

The current limit circuit and short protect circuit operate in relation to the level of output current. Further, the IC's internal circuitry can be shutdown via the CE pin's signal.

Low ESR Capacitors

With the XC6205 series, a stable output voltage is achievable even if used with low ESR capacitors as a phase compensation circuit is built-in. In order to ensure the effectiveness of the phase compensation, we suggest that an output capacitor (CL) is connected as close as possible to the output pin (VOUT) and the VSS pin. Please use an output capacitor with a capacitance value as shown in the figure below. Also, please connect an input capacitor (CIN) of 0.1 μ F between the VIN pin and the VSS pin in order to ensure a stable power input.

Recommended Output Capacitor Values

VOUT	0.9V ~ 1.2V	1.25V ~ 1.75V
CL	4.7 μ F	2.2 μ F

Current Limiter, Short-Circuit Protection

The XC6205 series includes a combination of a fixed current limiter circuit & a foldback circuit which aid the operations of the current limiter and circuit protection. When the load current reaches the current limit level, the fixed current limiter circuit operates and output voltage drops. As a result of this drop in output voltage, the foldback circuit operates, output voltage drops further and output current decreases. When the output pin is shorted, a current of about 50mA flows. However, when the input/output voltage differential is quite small, this current will be about 200mA.

CE Pin

The IC's internal circuitry can be shutdown via the signal from the CE pin with the XC6205 series. In shutdown mode, output at the VOUT pin will be pulled down to the VSS level via R1 & R2. The operational logic of the IC's CE pin is selectable (please refer to the selection guide on page 2). Note that as the standard XC6205B type is 'High Active/No Pull Down', operations will become unstable with the CE pin open. Although the CE pin is equal to an inverter input with CMOS hysteresis, with either the pull-up or pull-down options, the CE pin input current will increase when the IC is in operation. We suggest that you use this IC with either a VIN voltage or a VSS voltage input at the CE pin. If this IC is used with the correct specifications for the CE pin, the IC will operate normally. However, supply current may increase as a result of through current in the IC's internal circuitry.

Minimum Operating Voltage

In order to stabilize the IC's operations, an input voltage of more than 2.0V is needed. Should the input voltage be less than 2.0V, the output voltage may not be regulated correctly. (Please refer to the graph data below.)

- ① When V_{IN} is less than 2.0V, the CE pin remains in standby mode. When V_{IN} rises above 2.0V, the power supply will turn ON.
- ② The input power supply will begin to rise after a few hundred μsec . (Please also refer to the transient response characteristics.)

○ Input Voltage vs. Output Voltage

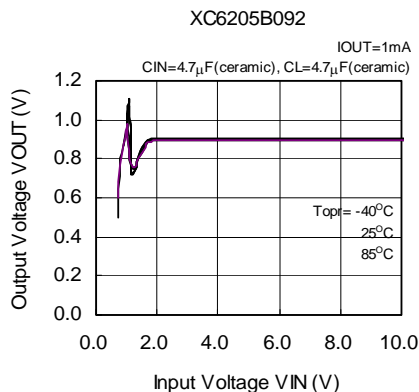

○ Enable Response Time

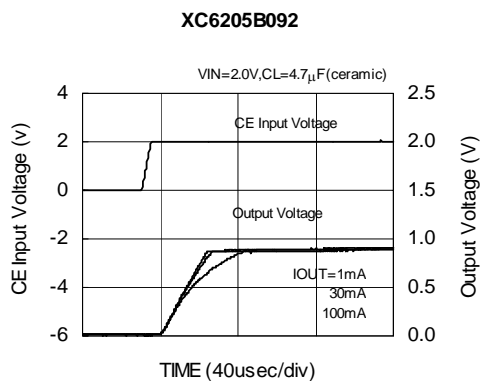

○ Turn-On Response Time

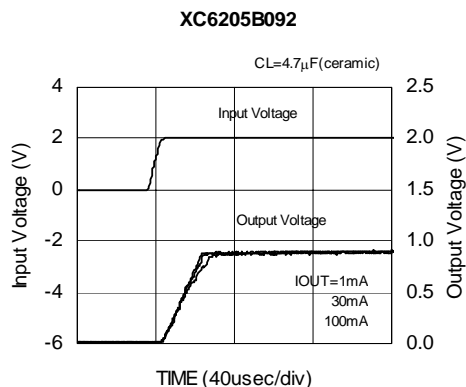

■ Notes on Use

- 1 Please use this IC within the stated absolute maximum ratings. The IC is liable to malfunction should the ratings be exceeded.
- 2 Where wiring impedance is high, operations may become unstable due to noise and/or phase lag depending on output current. Please strengthen V_{IN} and V_{SS} wiring in particular.
- 3 Please wire the input capacitor (C_{IN}) and the output capacitor (C_L) as close to the IC as possible.

XC6205

(1) Output Voltage vs. Output Current

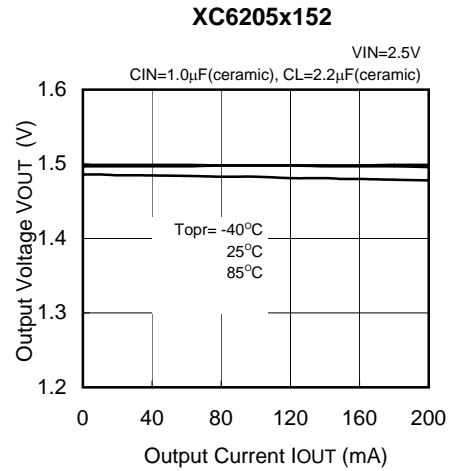
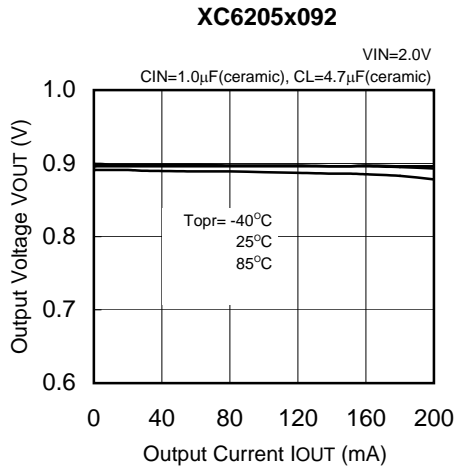

(2) Output Voltage vs. Output Current (current limit)

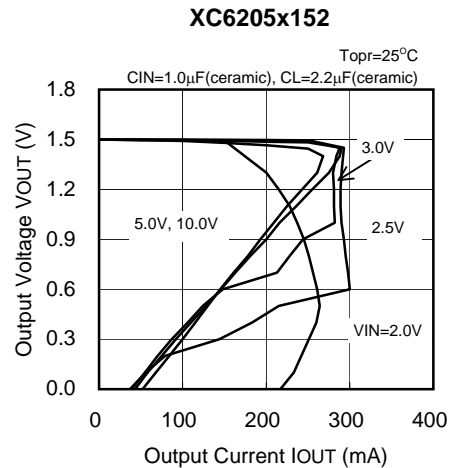
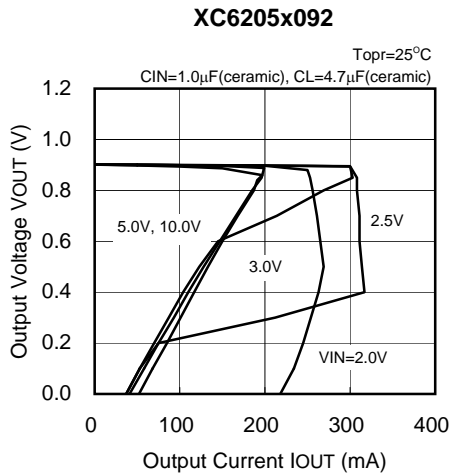
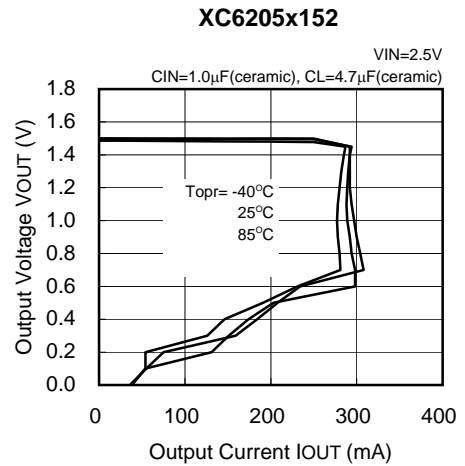
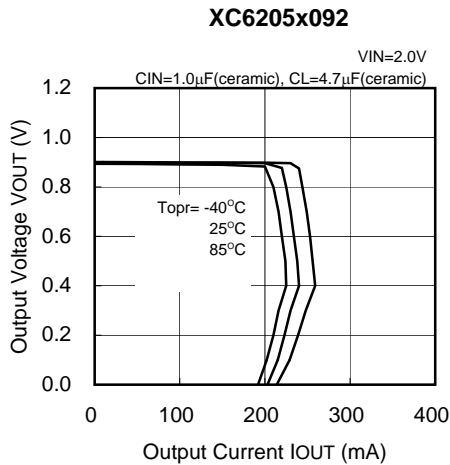

(3) Output Voltage vs. Input Voltage

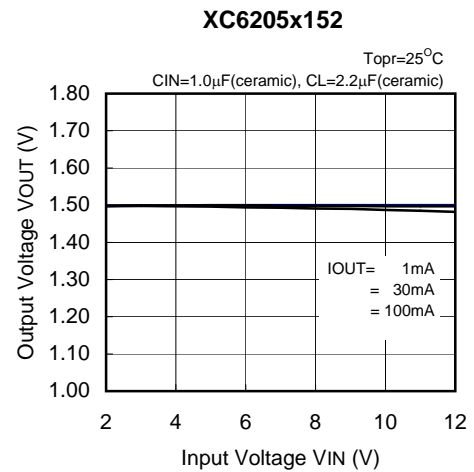
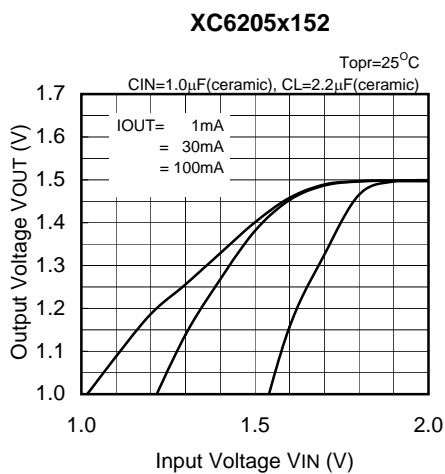
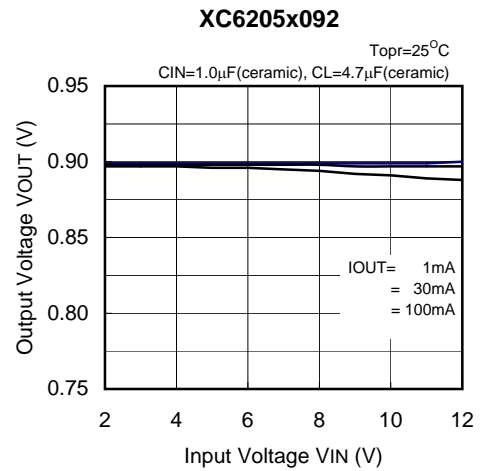
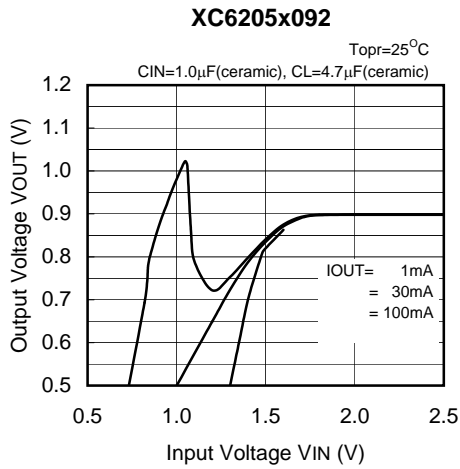

(4) Dropout Voltage vs. Output Current

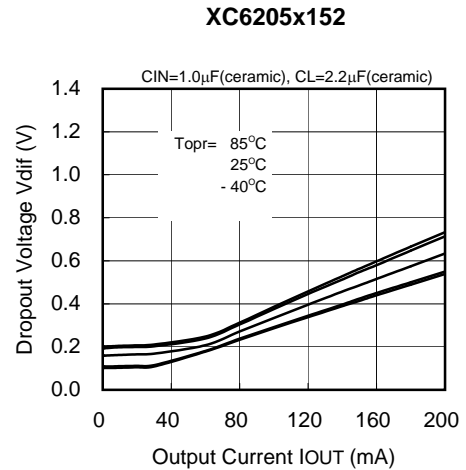
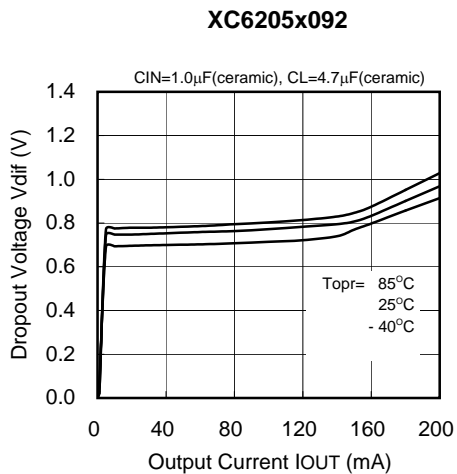

(5) Supply Current vs. Input Voltage

XC6205x092

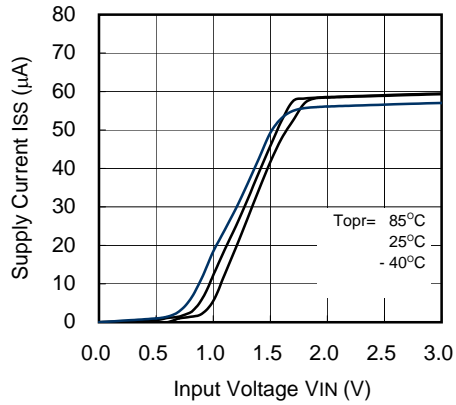

XC6205x092

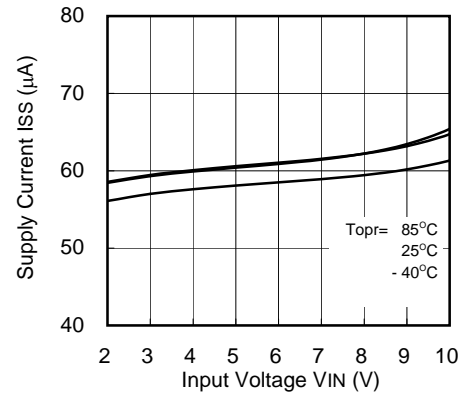

XC6205x152

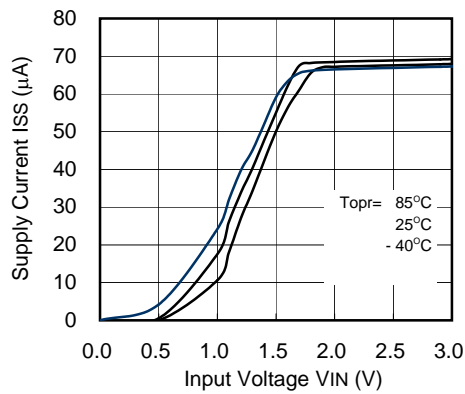

XC6205x152

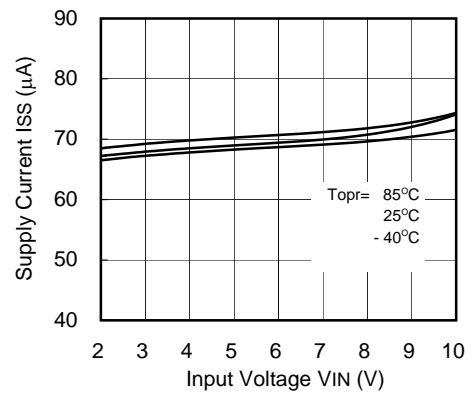

(6) Output Voltage vs. Ambient Temperature

XC6205x092

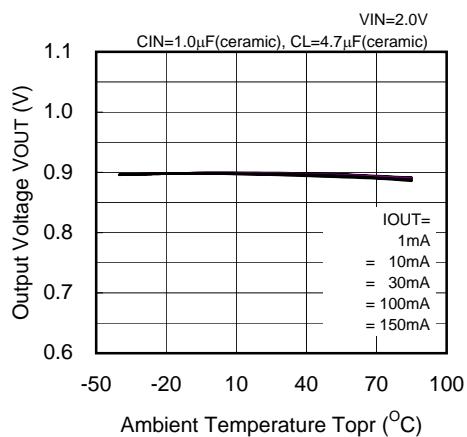

XC6205x152

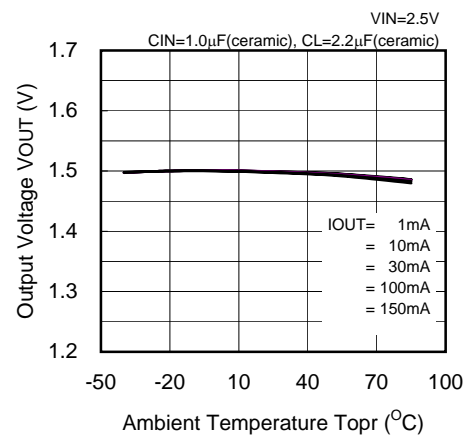

(7) Supply Current vs. Ambient Temperature

XC6205x092

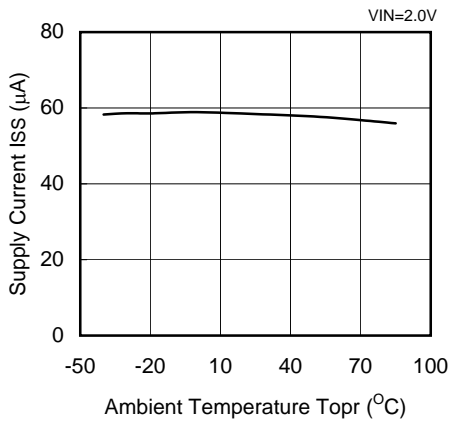

XC6205x152

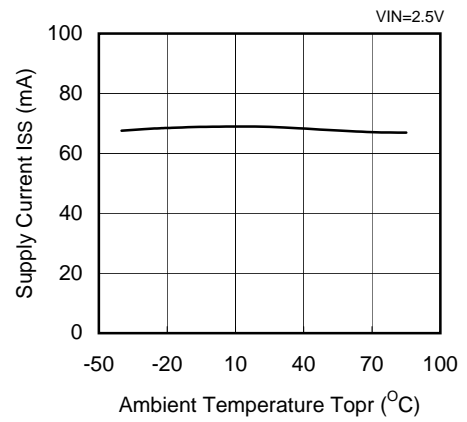

(8) CE Pin Threshold Voltage vs. Ambient Temperature

XC6205xxx2

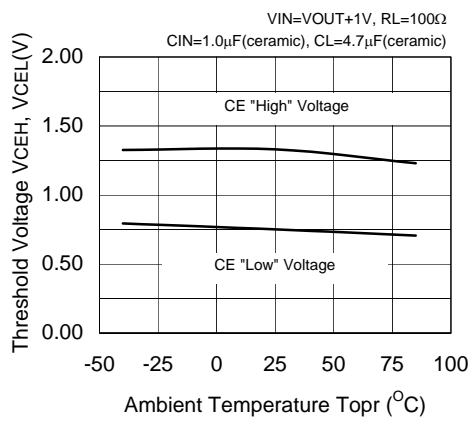

(9) Load Transient Response

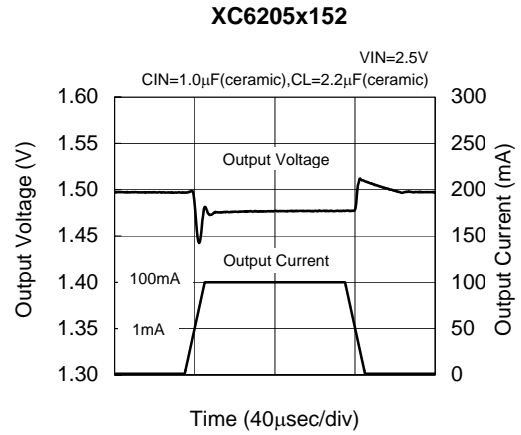
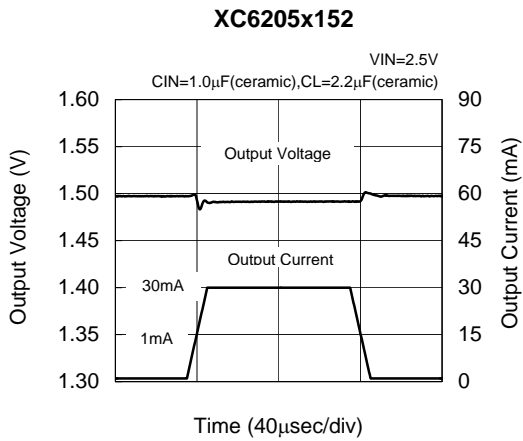
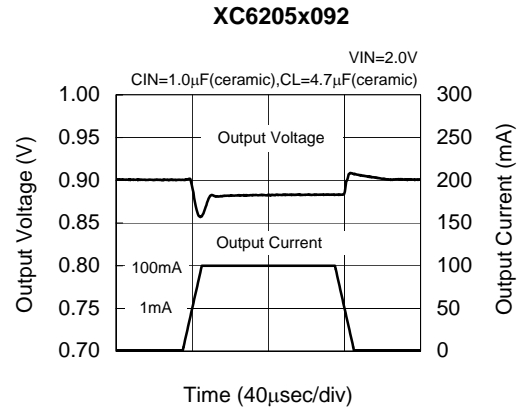
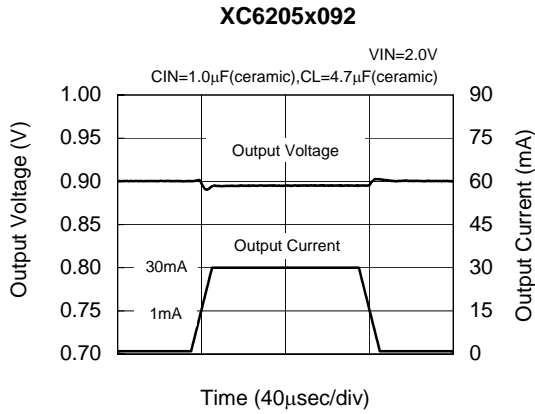

(10) Input Transient Response 1

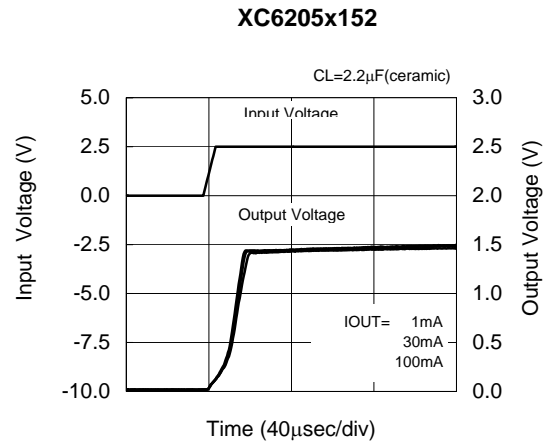
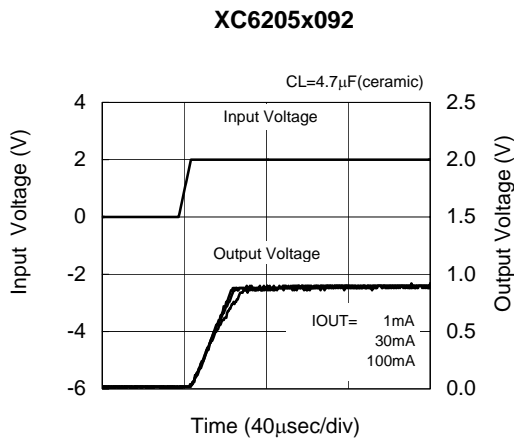

(11) Input Transient Response 2

XC6205x092

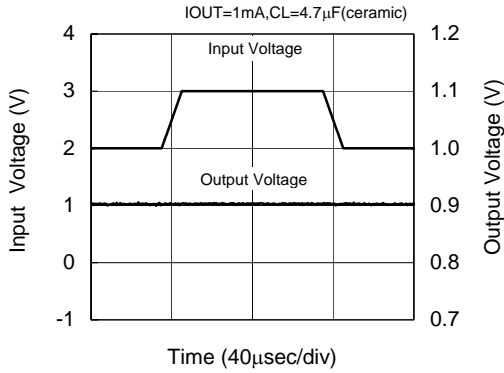

XC6205x092

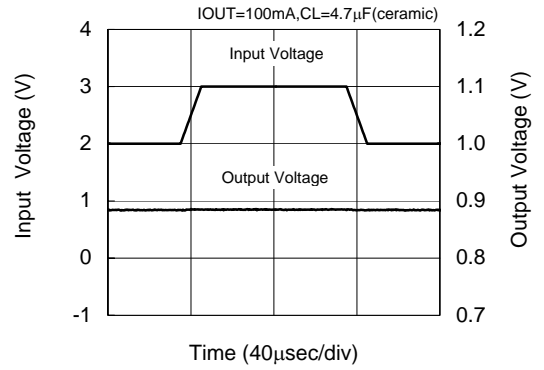

XC6205x152

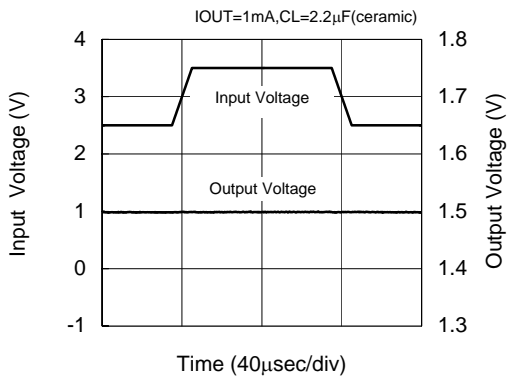

XC6205x152

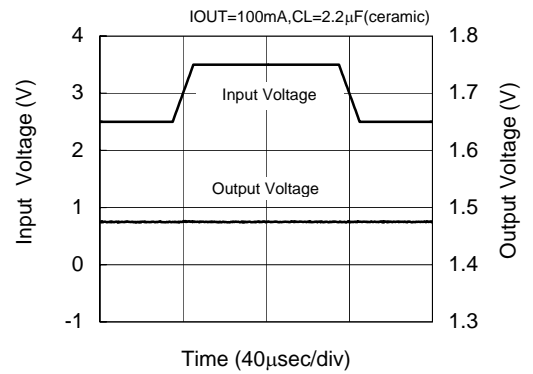

(12) Enable Response Time

XC6205B092

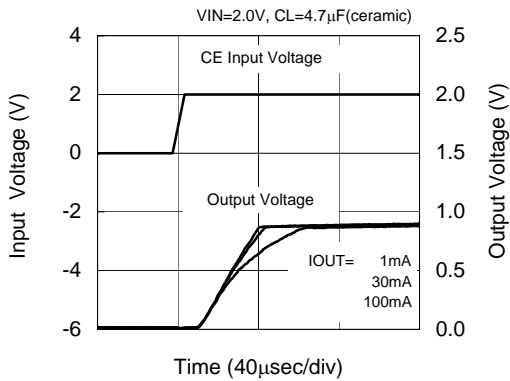

XC6205x152

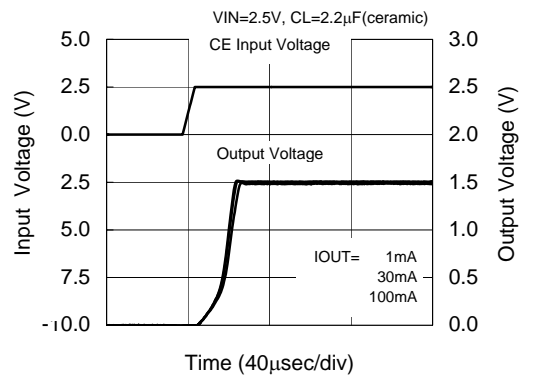

(13) Ripple Rejection Rate

