

SPECIFICATION FOR LCD MODULE

Model No. TM640480ACCWT

Prepared by:	Date:
Checked by :	Date:
Verified by :	Date:
Approved by:	Date:

TIANMA MICROELECTRONICS CO., LTD

REVISION RECORD

Date	Ver.	Ref. Page	Revision No.	Revision Item
2003-8-7	1.0			

1. General Specifications:

- 1.1 Display type: FSTN (dual mode)
- 1.2 Display color*:
 - Display color: Black
 - Background: White
- 1.3 Polarizer mode: Transflective/Positive
- 1.4 Viewing Angle: 6:00
- 1.5 Driving Method: 1/240 Duty 1/13 Bias
- 1.6 LCD operating voltage: 23.3V
- 1.7 VDD: 3.3V
- 1.8 Backlight: LED (White)
- 1.9 Driver: S6B0794X01-07 (X11)
- 1.10 Data Transfer: 4 Bit Parallel
- 1.11 Operating Temperature: -20----+70°C
 - Storage Temperature: -30----+80°C
- 1.12 Outline Dimensions: Refer to outline drawing on next page
- 1.13 Dot Matrix: 640 X 480 Dots
- 1.14 Dot Size: 0.25X0.29 (mm)
- 1.15 Dot Pitch: 0.28X0.32 (mm)
- 1.16 Weight: Approx 1200g

* Color tone is slightly changed by temperature and driving voltage.

2. Outline Drawing

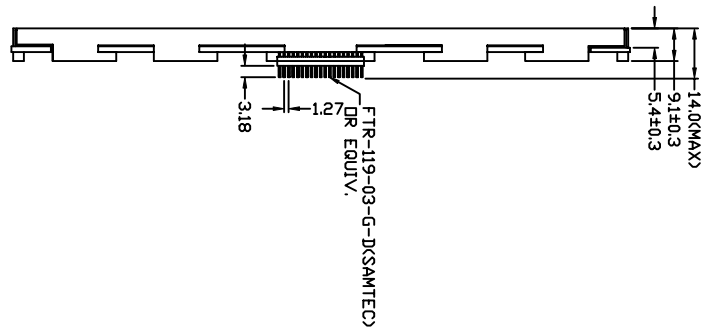
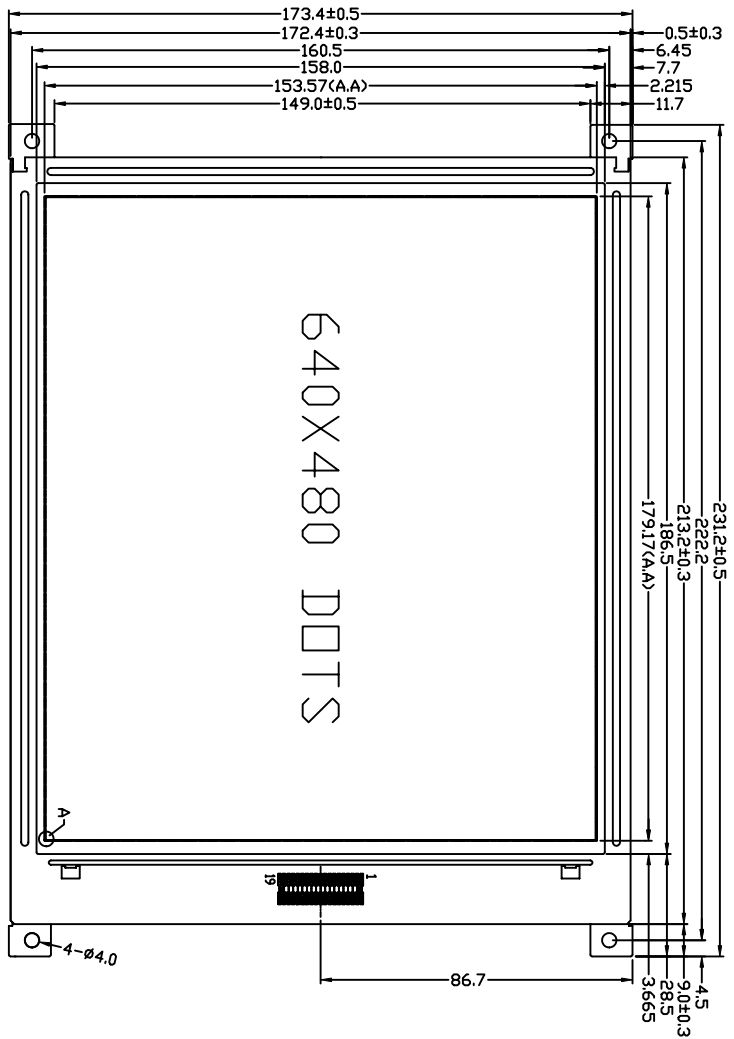

NO.	SYMBOL
1	VDD
2	VSS
3	/DDEF
4	YD
5	LP
6	XSCL
7	WF
8	LD0
9	LD1
10	LD2
11	LD3
12	UD0
13	UD1
14	UD2
15	UD3
16	V0
17	VEE
18	LED+
19	LED-

DETAIL A:

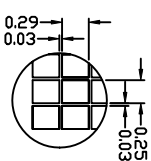

- NOTES:
- 1.DISPLAY TYPE: FSTNDUAL SCAN
 - 2.VIEWING DIRECTION: 6/00
 - 3.POLARIZER MODE: TRANSPARENT/POSITIVE
 - 4.OPERATING TEMP: -20°C~+70°C
 - 5.STORAGE TEMP: -30°C~+80°C
 - 6.DRIVE METHOD: 1/240 DUTY 1/13 BIAS
 - 7.BACKLIGHT TYPE: LED(WHITE)POWER DISSIPATION<300mW>
 - 8.DRIVER: S6B0794X01-07(X11)
 - 9.LCD OPERATING VOLTAGE: 23.3V
 - 10.LOGIC VOLTAGE: 3.3V
 - 11.VUV-CUT LCD & ANTI-HUMIDITY,ANTI-MILDew AND ANTI-SALTFOG PCB
 - 12.BEZEL IS TO BE PAINTED WHITE.
 - 13.ALL UNMARKED TOLERANCES: ±0.20mm
 - 14.LCD NO: TLTBS-052



TIAN-MA MICROELECTRONICS CO.
6/F., CASTIC Building, Sherman Road, Central, Shenzhen, China

DRAWN BY:	TTITLE: TM640480ACCWT	SCALE:	UNIT: mm
CHECKED BY:	DWG NO: G-2		
APPROVED BY:	DWG NAME: TM640480ACCWT-2	SHEET NO: 1	OF 1
CONFIRMED BY:			

3. LCD Module Part Numbering System

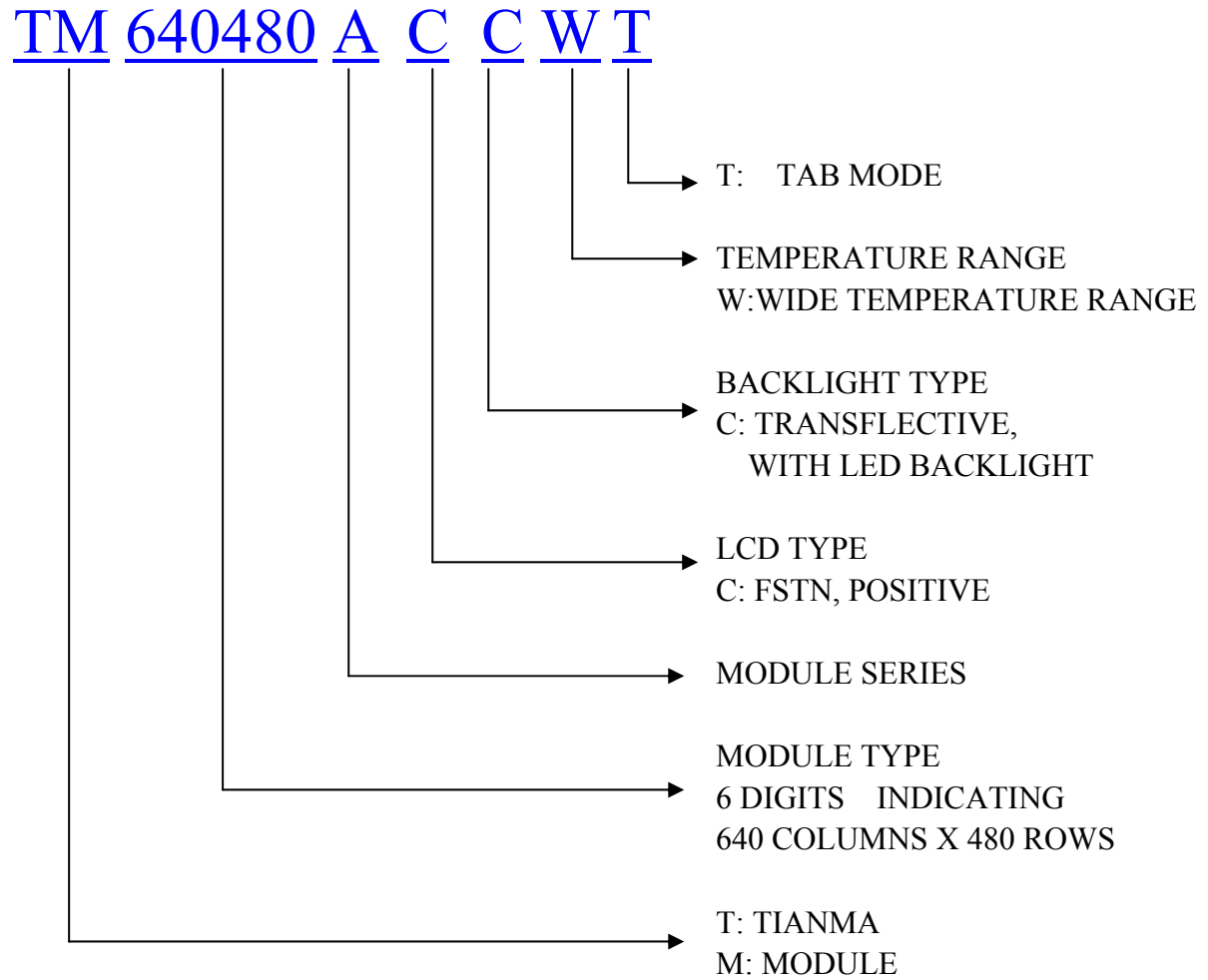

4. Electronic Character (Circuit Block Diagram)

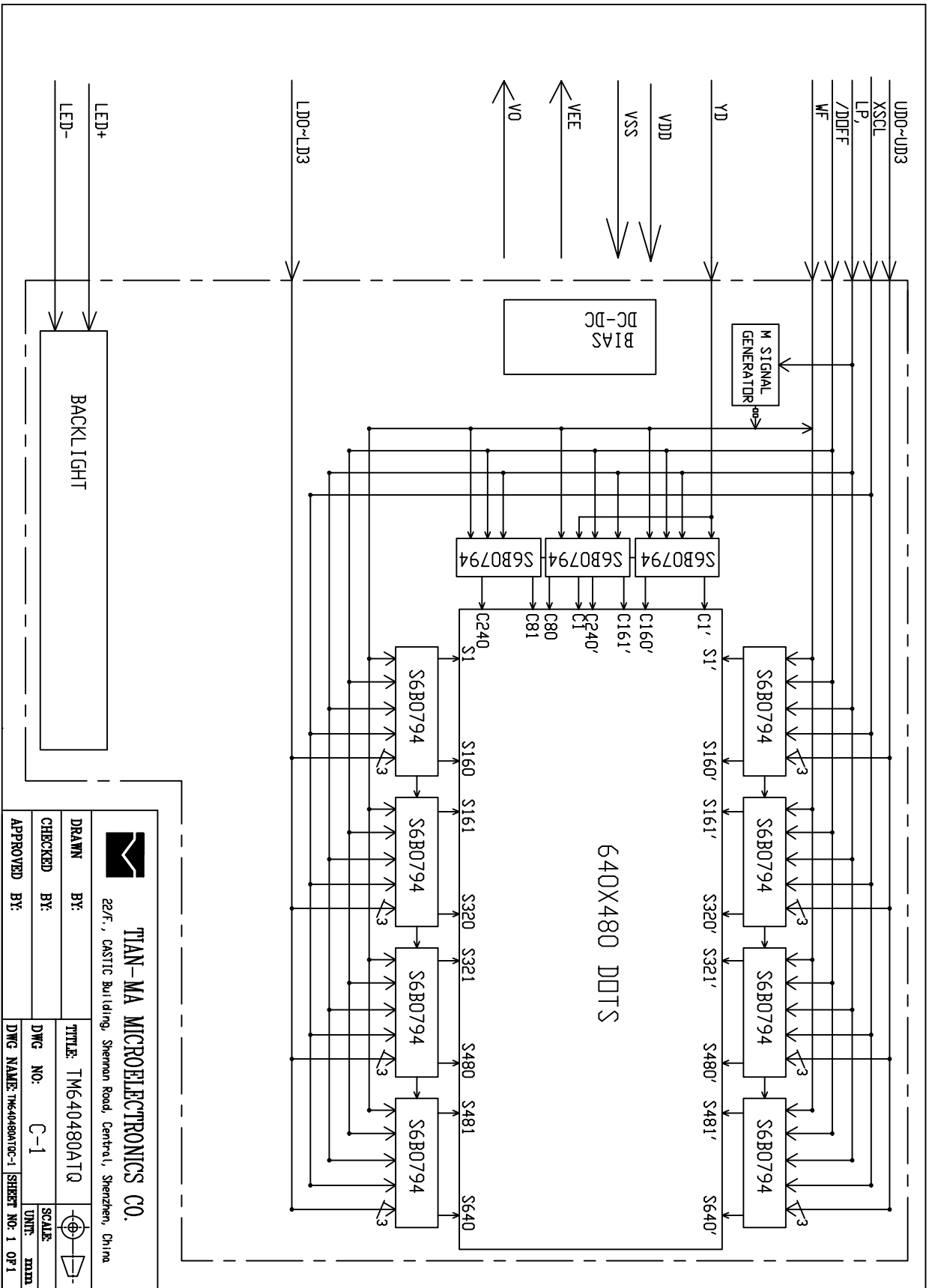

5. Absolute Maximum Ratings

Item	Symbol	Min.	Max.	Unit	Remark
Power Supply Voltage	$V_{DD}-V_{SS}$	-0.3	6.0	V	
LCD Driving Voltage	V_{LCD}	-	28.0		
Operating Temperature Range	T_{OP}	-20	+70	°C	No Condensation
Storage Temperature Range	T_{ST}	-30	+80		

6. Electrical Specifications and Instruction Code

6.1 Electrical characteristics

Item		Symbol	Min.	Typ.	Max.	Unit
Supply Voltage (Logic)		$V_{DD}-V_{SS}$	-	3.3	5.5	V
Supply Voltage (LCD Drive)		V_{LCD}	-	23.3	-	V
Input Signal Voltage	High	V_{IH} ($V_{DD}=3.0$)	$0.8V_{DD}$	-	$V_{DD}+0.3$	V
	Low	V_{IL} ($V_{DD}=3.0$)	0	-	$0.2V_{DD}$	V
Supply current (Logic)		I_{DD} ($V_{DD}-V_{SS}=3.3V$)	-	20.0	30.0	mA
Supply current (LED Drive)		I_{LED} ($LED+ - LED-=3.3V$)	-	70	100	mA

6.2 Interface Signals

Pin No.	Symbol	Level	Description
1	VDD	3.3V	Power Supply For LOGIC
2	VSS	0V	GROUND
3	/DOFF	H/L	H: Display On L: Display Off
4	YD	H/L	COM data signal
5	LP	H/L	Latch Pulse of Display Data
6	XSCL	H/L	Clock Pules for Segment Shift Register
7	WF	H/L	Switch Signal to Convert LCD Driver
8	LD0	H/L	Input Data bit for lower screen
9	LD1	H/L	
10	LD2	H/L	
11	LD3	H/L	
12	UD0	H/L	Input Data bit for upper screen
13	UD1	H/L	
14	UD2	H/L	
15	UD3	H/L	
16	V0	23.3V	LCD operating voltage; output
17	VEE	-	Built-in DC~DC CONVERTOR OUTPUT
18	LED+	3.3V	LED BACKLIGHT POWER SUPPLY
19	LED-	0V	

6.3 Interface Timing Chart

AC CHARACTERISTICS

SEGMENT MODE AC CHARACTERISTICS

Segment Mode 1

(V_{SS}=V_S=0V, V_{DD}=+4.5 to +5.5V, V₀=+15 to +32V, T_a=-20~85°C)

Parameter	Symbol	Conditions	Min.	Typ.	Max.	Unit
Shift clock period *1	TWCK	T _R , T _F ≤10 ns	71			ns
Shift clock "H" pulse width	TWCKH		23			ns
Shift clock "L" pulse width	TWCKL		23			ns
Data setup time	TDS		10			ns
Data hold time	TDH		20			ns
Latch pulse "H" pulse width	TWLPH		23			ns
Shift clock rise to latch pulse rise time	TLD		0			ns
Shift clock fall to latch pulse fall time	TSL		25			ns
Latch pulse rise to shift clock rise time	TLS		25			ns
Latch pulse fall to shift clock fall time	TLH		25			ns
Input signal rise time *2	T _R				50	ns
Input signal fall time *2	T _F				50	ns
Enable setup time	T _S		21			ns
DISPOFFB removal time	T _{SD}		100			ns
DISPOFFB "L" pulse width	TWDL		1.2			us
Output delay time (1)	T _D	C _L =15pF			40	ns
Output delay time (2)	T _{PD1} , T _{PD2}	C _L =15pF			1.2	us
Output delay time (3)	T _{PD3}	C _L =15pF			1.2	us

Note : *1 Take the cascade connection into consideration.

*2 (TWCK – TWCKH – TWCKL) / 2 is maximum in the case of high speed operation.

Segment Mode 2

(V_{SS}=V₅=0V, V_{DD}=+2.4V to +4.5V, V₀=+15 to +32V, T_a=-20~85°C)

Parameter	Symbol	Conditions	Min.	Typ.	Max.	Unit
Shift clock period *1	TWCK	T _R , T _F ≤10 ns	125			ns
Shift clock "H" pulse width	TWCKH		51			ns
Shift clock "L" pulse width	TWCKL		51			ns
Data setup time	TDS		30			ns
Data hold time	TDH		40			ns
Latch pulse "H" pulse width	TWLPH		51			ns
Shift clock rise to latch pulse rise time	TLD		0			ns
Shift clock fall to latch pulse fall time	TSL		51			ns
Latch pulse rise to shift clock rise time	TLS		51			ns
Latch pulse fall to shift clock fall time	TLH		51			ns
Input signal rise time *2	T _R				50	ns
Input signal fall time *2	T _F				50	ns
Enable setup time	T _S		36			ns
DISPOFFB removal time	TSD		100			ns
DISPOFFB "L" pulse width	TWDL		1.2			us
Output delay time (1)	T _D	C _L =15pF			78	ns
Output delay time (2)	T _{PD1} , T _{PD2}	C _L =15pF			1.2	us
Output delay time (3)	T _{PD3}	C _L =15pF			1.2	us

Note : *1 Take the cascade connection into consideration.

*2 (TWCK – TWCKH – TWCKL) / 2 is maximum in the case of high speed operation.

Timing Characteristics of Segment Mode

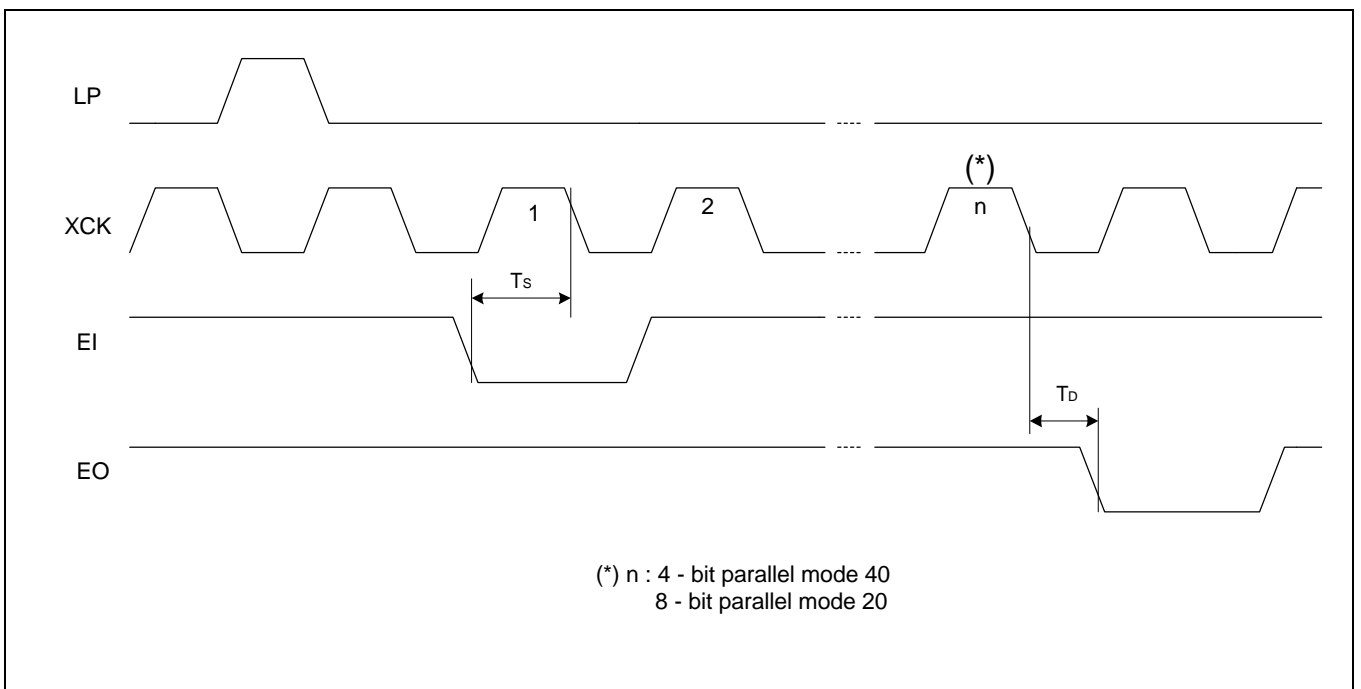
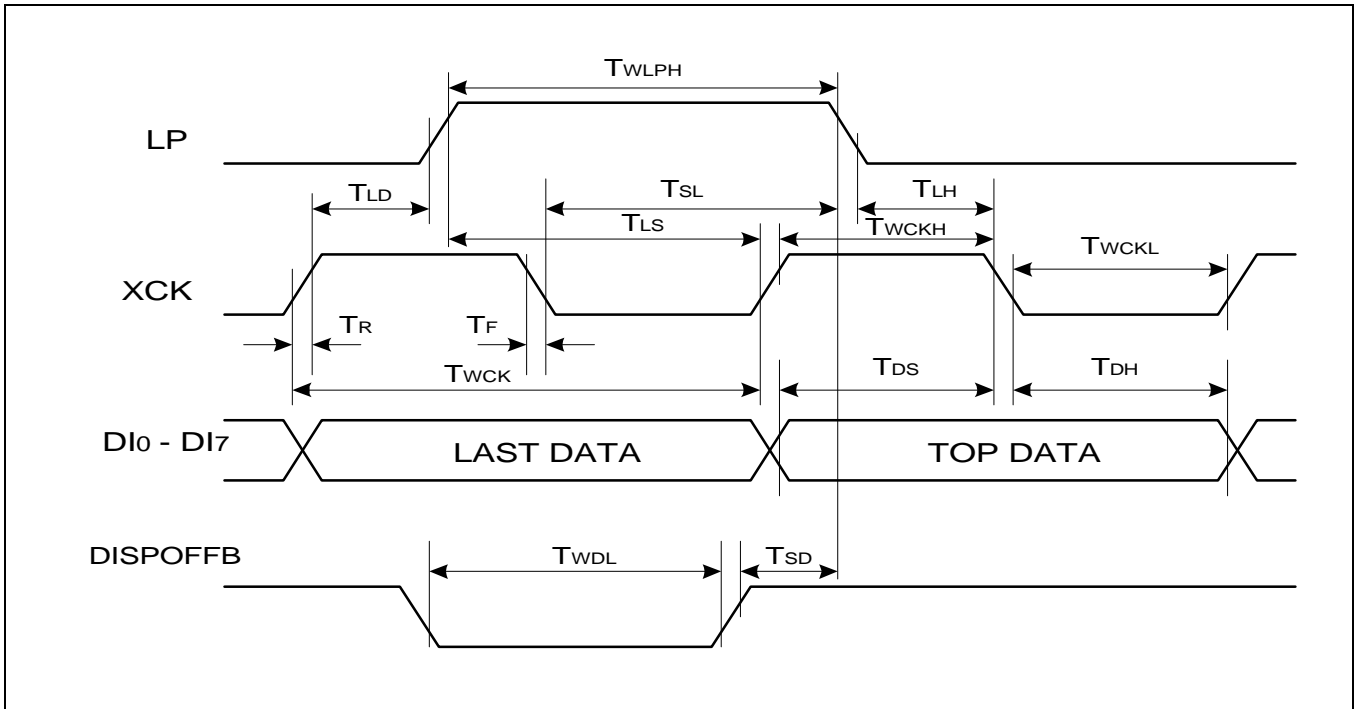

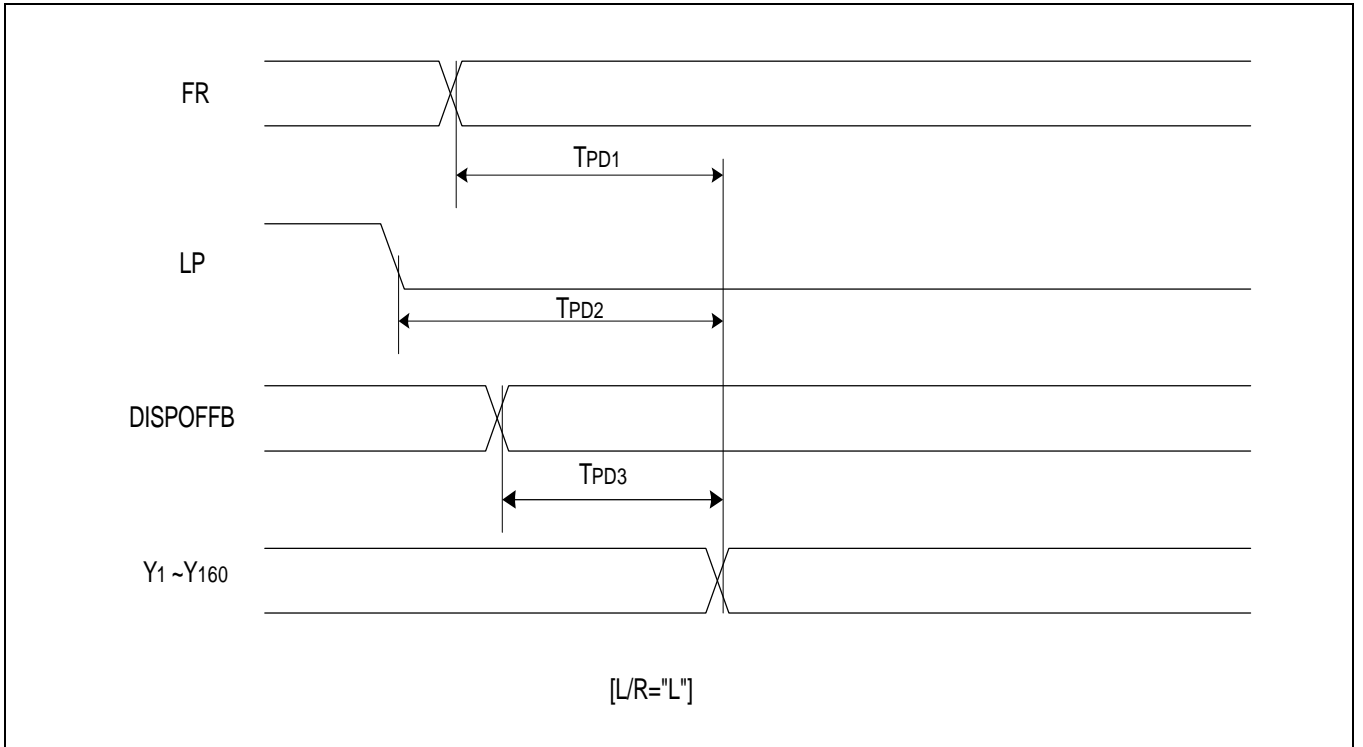

COMMON MODE AC CHARACTERISTICS

Common Mode

($V_{SS}=V_5=0V$, $V_{DD}=+2.4V$ to $+4.5V$, $V_0=+15$ to $+32V$, $T_a=-20\sim 85^\circ C$)

Parameter	Symbol	Condition	Min.	Typ.	Max.	Unit
Shift clock period	T_{WLP}	$T_R, T_F \leq 20ns$	250			ns
Shift "H" pulse width	T_{WLPH}	$V_{DD}=+5.0V \pm 10\%$	15			ns
		$V_{DD}=+2.5V \sim +4.5V$	30			ns
Data setup time	T_{SU}		30			ns
Data hold time	T_H		50			ns
Input signal rise time	T_R				50	ns
Input signal fall time	T_F				50	ns
DISPOFFB removal time	T_{SD}		100			ns
DISPOFFB 'L' pulse width	T_{WDL}		1.2			us
Output delay time (1)	T_{DL}	$CL=15pF$			200	ns
Output delay time (2)	T_{PD1}, T_{PD2}	$CL=15pF$			1.2	us
Output delay time (3)	T_{PD3}	$CL=15pF$			1.2	us

Timing Characteristics of Common Mode

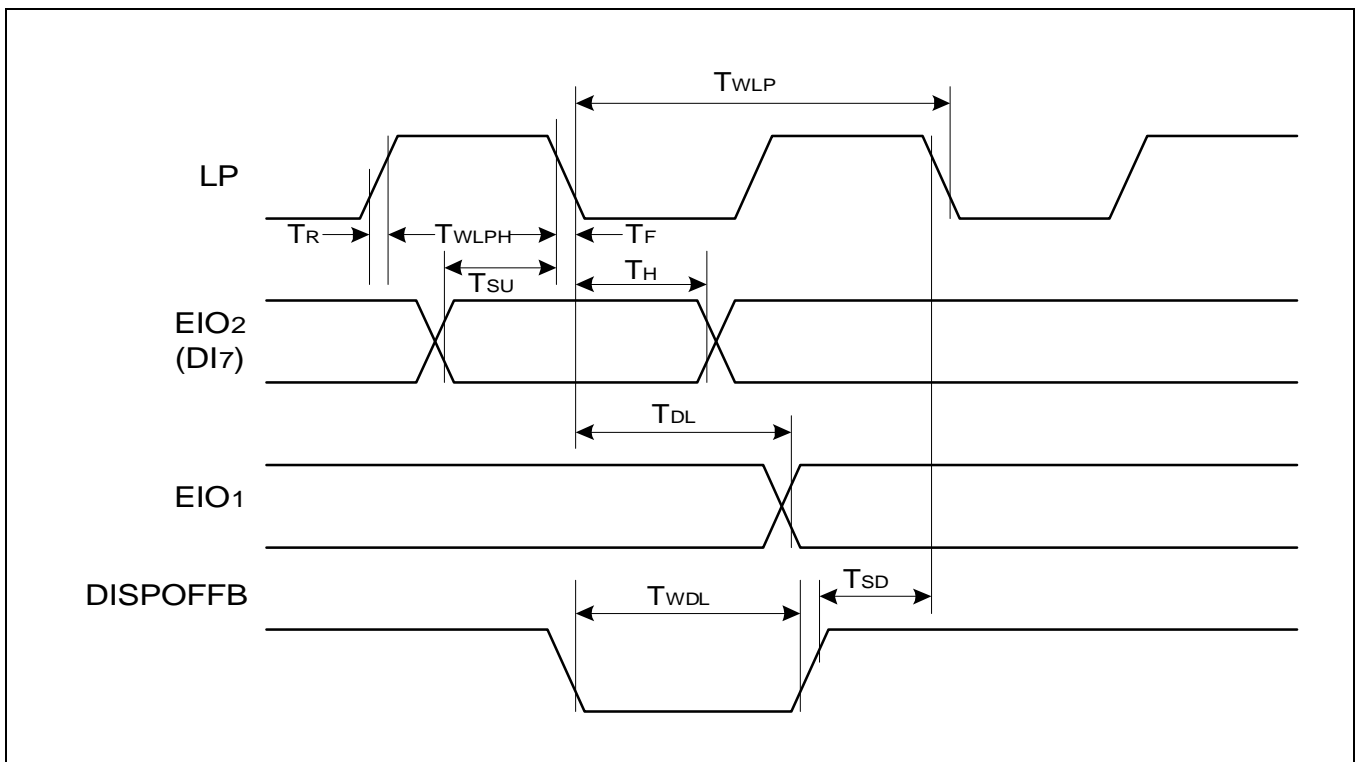

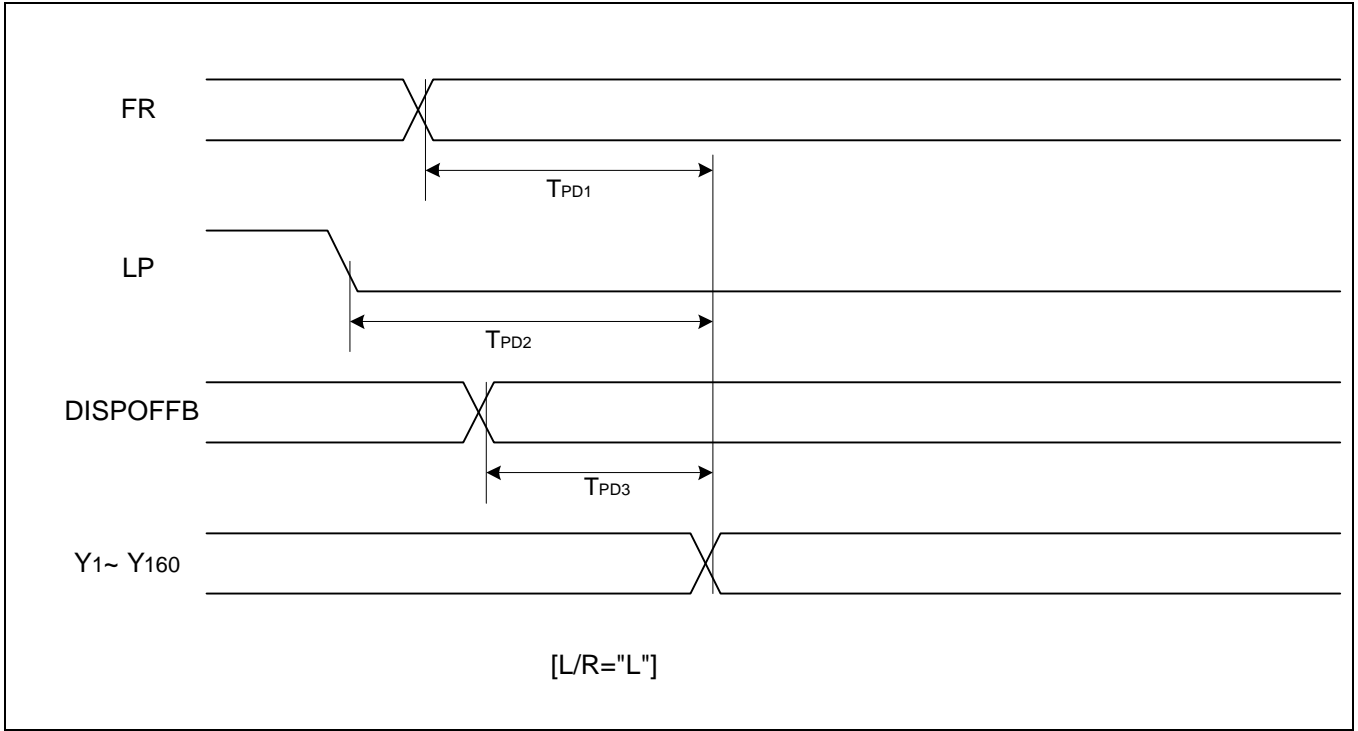

7. Optical Characteristics

7.1 Optical Characteristics

Ta=25°C

Item	Symbol	Condition	Min.	Typ.	Max.	Unit	
Viewing Angle	θ_x	$C_r \geq 2$	$\theta_y = 0^\circ$	-30	--	30	Deg
	θ_y						
Contrast Ratio	C_r	$\theta_x = 0^\circ$ $\theta_y = 0^\circ$	3.0	-	-		
Response Time	Turn on	T_{on}	$\theta_x = 0^\circ$ $\theta_y = 0^\circ$	-	-	350	ms
	Turn off	T_{off}				-	

7.2 Definition of Optical Characteristics

7.2.1 Definition of Viewing Angle

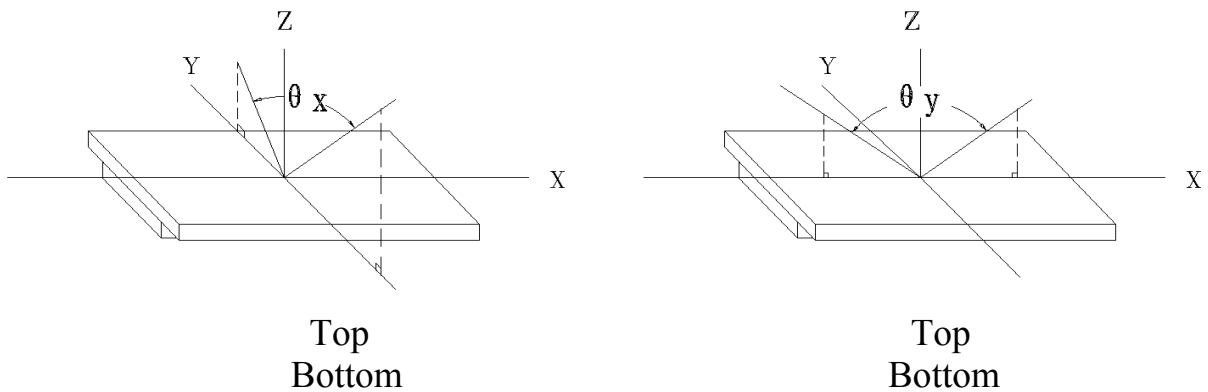

7.2.2 Definition of Contrast Ratio

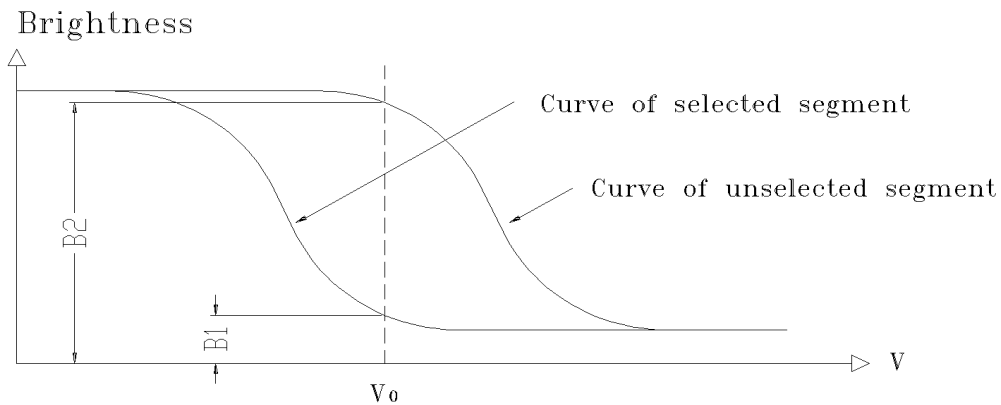

$$\text{Contrast Ratio} = B2/B1 = \frac{\text{unselected state brightness}}{\text{selected state brightness}}$$

Measuring Conditions:

- 1) Ambient Temperature: 25°C ;
- 2) Frame frequency: 70Hz

7.2.3 Definition of Response time

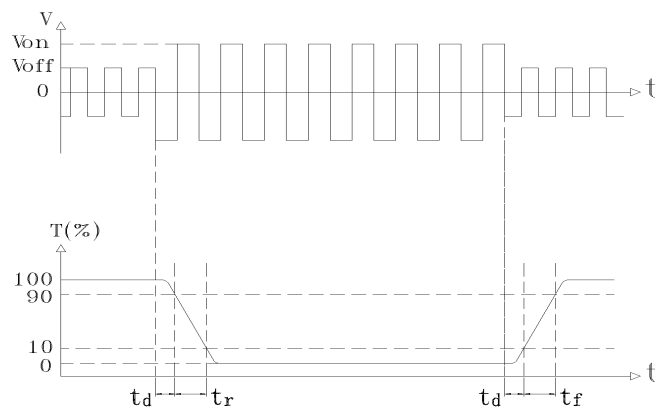

Turn on time: $t_{on} = t_d + t_r$ Turn off time: $t_{off} = t_d + t_f$

Measuring Condition:

- 1) Operating Voltage: 23.3V ;
- 2) Frame frequency: 70Hz

8. Reliability

8.1 Content of Reliability Test

Ta=25°C

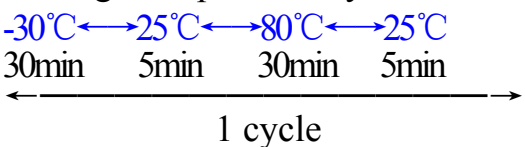
No.	Test Item	Content of Test	Test condition
1	High Temperature Storage	Endurance test applying the high storage temperature for a long time	80°C 240H Restore 4H at 25°C
2	Low Temperature Storage	Endurance test applying the low storage temperature for a long time	-30°C 240H Restore 4H at 25°C
3	High Temperature /Humidity Storage	Endurance test applying the high temperature and high humidity storage for a long time	60°C 90%RH 240H Restore 4H at 25°C
4	Temperature Cycle	Endurance test applying the low and high temperature cycle 	-30°C/80°C 10 cycles Restore 4H at 25°C
5	Vibration Test (package state)	Endurance test applying the vibration during transportation	10Hz~500Hz, 100m/s ² , 120min
6	Shock Test (package state)	Endurance test applying the shock during transportation	Half- sine wave, 300m/s ² , 18ms
7	Atmospheric Pressure Test	Endurance test applying the atmospheric pressure during transportation by air	25kPa 16H Restore 2H

8.2 Failure Judgment Criterion

Criterion Item	Test Item No.							Failure Judgement Criterion
	1	2	3	4	5	6	7	
Basic Specification	√	√	√	√	√	√	√	Out of the basic Specification
Electrical Specification	√	√	√					Out of the electrical specification
Mechanical Specification					√	√		Out of the mechanical specification
Optical Characteristic	√	√	√	√			√	Out of the optical specification
Note	For test item refer to 8.1							
Remark	Basic specification = Optical specification + Mechanical specification							

9. QUALITY LEVEL

Examination or Test	At $T_a=25^{\circ}\text{C}$ (unless otherwise stated)	Inspection				
		Min.	Max.	Unit	IL	AQL
External Visual Inspection	Under normal illumination and eyesight condition, the distance between eyes and LCD is 25cm.	See Appendix A			II	Major 1.0 Minor 2.5
Display Defects	Under normal illumination and eyesight condition, display on inspection.	See Appendix B			II	Major 1.0 Minor 2.5
Note: Major defects: Open segment or common, Short, Serious damages, Leakage Miner defects: Others Sampling standard conforms to GB2828						

10. Precautions for Use of LCD Modules

10.1 Handling Precautions

10.1.1 The display panel is made of glass. Do not subject it to a mechanical shock by dropping it from a high place, etc.

10.1.2 If the display panel is damaged and the liquid crystal substance inside it leaks out, be sure not to get any in your mouth, if the substance comes into contact with your skin or clothes, promptly wash it off using soap and water.

10.1.3 Do not apply excessive force to the display surface or the adjoining areas since this may cause the color tone to vary.

10.1.4 The polarizer covering the display surface of the LCD module is soft and easily scratched. Handle this polarizer carefully.

10.1.5 If the display surface is contaminated, breathe on the surface and gently wipe it with a soft dry cloth. If still not completely clear, moisten cloth with one of the following solvents:

- Isopropyl alcohol
- Ethyl alcohol

Solvents other than those mentioned above may damage the polarizer. Especially, do not use the following:

- Water
- Ketone
- Aromatic solvents

10.1.6 Do not attempt to disassemble the LCD Module.

10.1.7 If the logic circuit power is off, do not apply the input signals.

10.1.8 To prevent destruction of the elements by static electricity, be careful to maintain an optimum work environment.

- a. Be sure to ground the body when handling the LCD Modules.
- b. Tools required for assembly, such as soldering irons, must be properly ground.
- c. To reduce the amount of static electricity generated, do not conduct assembly and other work under dry conditions.
- d. The LCD Module is coated with a film to protect the display surface. Be care when peeling off this protective film since static electricity may be generated.

10.2 Storage precautions

10.2.1 When storing the LCD modules, avoid exposure to direct sunlight or to the light of fluorescent lamps.

10.2.2 The LCD modules should be stored under the storage temperature range. If the LCD modules will be stored for a long time, the recommend condition is:

Temperature : $0^{\circ}\text{C} \sim 40^{\circ}\text{C}$

Relatively humidity: $\leq 80\%$

10.2.3 The LCD modules should be stored in the room without acid, alkali and harmful gas.

10.3 The LCD modules should be no falling and violent shocking during transportation, and also should avoid excessive press, water, damp and sunshine.

Appendix A

Inspection items and criteria for appearance defects

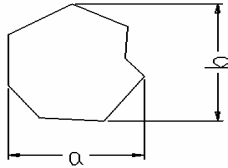
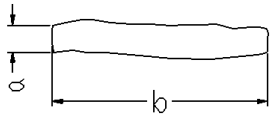
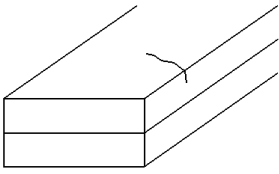
Items	Contents	Criteria			
Leakage		Not permitted			
Rainbow		According to the limit specimen			
Polarizer	Wrong polarizer attachment	Not permitted			
	Bubble between polarizer and glass	Not counted	Max. 3 defects allowed		
		$\phi < 0.3\text{mm}$	$0.3\text{mm} \leq \phi \leq 0.5\text{mm}$		
	Scratches of polarizer	According to the limit specimen			
Black spot (in viewing area)		Not counted	Max. 3 spots allowed	Max. 3 spots (lines) allowed	
		$X < 0.2\text{mm}$	$0.2\text{mm} \leq X \leq 0.5\text{mm}$		
		$X = (a+b)/2$			
Black line (in viewing area)		Not counted	Max. 3 lines allowed		
		$a < 0.02\text{mm}$	$0.02\text{mm} \leq a \leq 0.05\text{mm}$ $b \leq 2.0\text{mm}$		
Progressive cracks		Not permitted			

Appendix A

Inspection item and criteria for appearance defects (continued)

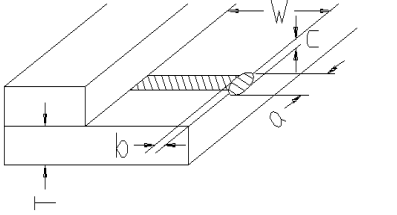
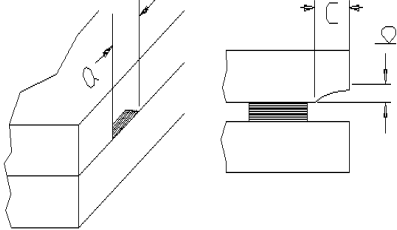
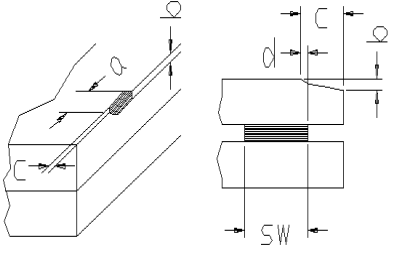
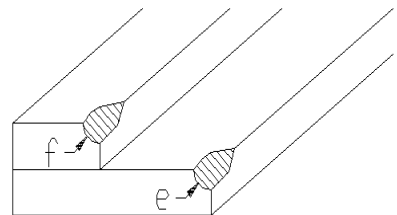
Items	Contents	Criteria				
Glass Cracks	<p>Cracks on pads</p> 	a	b	c	Max. 2 cracks allowed	Max. 5 cracks allowed
	$\leq 3\text{mm}$	$\leq W/5$	$\leq T/2$			
	$\leq 2\text{mm}$	$\leq W/5$	$T/2 < C < T$			
	<p>Cracks on contact side</p> 	a	b	Max. 2 cracks allowed		
	$\leq 3\text{mm}$	$\leq T/2$				
	$\leq 2\text{mm}$	$T/2 < b < T$				
	C shall be not reach the seal area					
<p>Cracks on non-contact side</p> 	a	b	Max. 2 cracks allowed			
$\leq 3\text{mm}$	$\leq T/2$					
$\leq 2\text{mm}$	$T/2 < b < T$					
$C \leq 0.5\text{mm}$						
$d \leq SW/3$						
<p>Corner cracks</p> 	$e < 2.0\text{mm}^2$ $f < 2.0\text{mm}^2$		Max. 3 cracks allowed			
Others	Double side glue	Not serious crimped				
	Pin of TCP IC	Full tinning				
	Protective glue on IC chip	No seeing the IC chip if scratched				

Appendix B

Inspection items and criteria for display defects

Items	Contents	Criteria		
Open segment or open common		Not permitted		
Short		Not permitted		
Wrong viewing angle		Not permitted		
Contrast ratio uneven		According to the limit specimen		
Crosstalk		According to the limit specimen		
Pin holes and cracks in segment (DOT)		Not counted	Max.3 dots allowed	Max.3 dots allowed
		$X < 0.1\text{mm}$	$0.1\text{mm} \leq X \leq 0.2\text{mm}$	
		$X = (a+b)/2$		
		Not counted	Max.2 dots allowed	
$A < 0.1\text{mm}$		$0.1\text{mm} \leq A \leq 0.2\text{mm}$ $D < 0.25\text{mm}$		
Black spot (in viewing area)		Not counted	Max.3 spots allowed	Max.3 spots (lines) allowed
		$X < 0.1\text{mm}$	$0.1\text{mm} \leq X \leq 0.2\text{mm}$	
		$X = (a+b)/2$		
Black line (in viewing area)		Not counted	Max.3 lines allowed	
		$a < 0.02\text{mm}$	$0.02\text{mm} \leq a \leq 0.05\text{mm}$ $b \leq 0.5\text{mm}$	

Appendix B

Inspection items and criteria for display defects (continued)

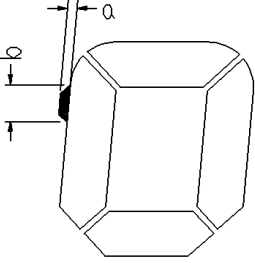
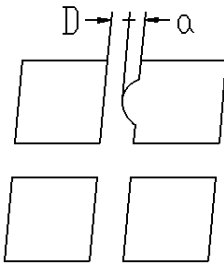
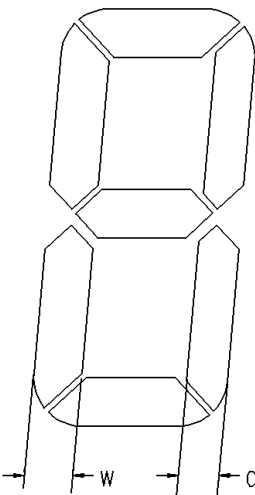
Items	Content	Criteria			
Transformation of segment		Not counted	Max. 2 defects allowed	Max.3 defects allowed	
		$x < 0.1\text{mm}$	$0.1\text{mm} \leq x \leq 0.2\text{mm}$		
		$x = (a+b)/2$			
		Not counted	Max. 1 defects allowed		
		$a < 0.1\text{mm}$	$0.1\text{mm} \leq a \leq 0.2\text{mm}$ $D > 0$		
		Max.2 defects allowed $0.8W \leq a \leq 1.2W$			
	$a = \text{measured value of width}$ $W = \text{nominal value of width}$				