

Low Noise/Low Power/I²C Bus/256 Taps

The ISL90810 integrates a digitally controlled potentiometer (XDCP) on a monolithic CMOS integrated circuit.

The digitally controlled potentiometers are implemented with a combination of resistor elements and CMOS switches. The position of the wipers are controlled by the user through the I²C bus interface. Each potentiometer has an associated Wiper Register (WR) that can be directly written to and read by the user. The contents of the WR controls the position of the wiper. When powered on the ISL90810's wiper will always commence at mid-scale (128 tap position).

The DCP can be used as three-terminal potentiometer or as two-terminal variable resistor in a wide variety of applications including control, parameter adjustments, and signal processing.

Features

- 256 resistor taps - 0.4% resolution
- I²C serial interface with write/read capability
- Power-on preset to mid-scale (128 tap position)
- Wiper resistance: 70Ω typical @ 3.3V
- Standby current 5μA max
- Power supply: 2.7V to 5.5V
- 50kΩ, 10kΩ total resistance
- 8 Ld MSOP
- Pb-free plus anneal available (RoHS compliant)

Pinout

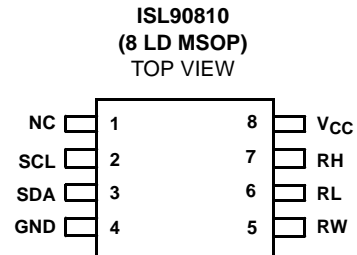

Ordering Information

PART NUMBER	PART MARKING	R _{TOTAL} (kΩ)	TEMP RANGE (°C)	PACKAGE	PKG. DWG#
ISL90810WIU8	AJL	10	-40 to +85	8 Ld MSOP	M8.118
ISL90810WIU8Z* (Note)	DEN	10	-40 to +85	8 Ld MSOP (Pb-free)	M8.118
ISL90810WUAU8Z* (Note)	810WA	10	-40 to +105	8 Ld MSOP (Pb-free)	M8.118
ISL90810UIU8	AJK	50	-40 to +85	8 Ld MSOP	M8.118
ISL90810UIU8Z* (Note)	DEM	50	-40 to +85	8 Ld MSOP (Pb-free)	M8.118
ISL90810UAU8Z* (Note)	810UA	50	-40 to +105	8 Ld MSOP (Pb-free)	M8.118

*Add "-TK" suffix for tape and reel.

NOTE: Intersil Pb-free plus anneal products employ special Pb-free material sets; molding compounds/die attach materials and 100% matte tin plate termination finish, which are RoHS compliant and compatible with both SnPb and Pb-free soldering operations. Intersil Pb-free products are MSL classified at Pb-free peak reflow temperatures that meet or exceed the Pb-free requirements of IPC/JEDEC J STD-020.

Block Diagram

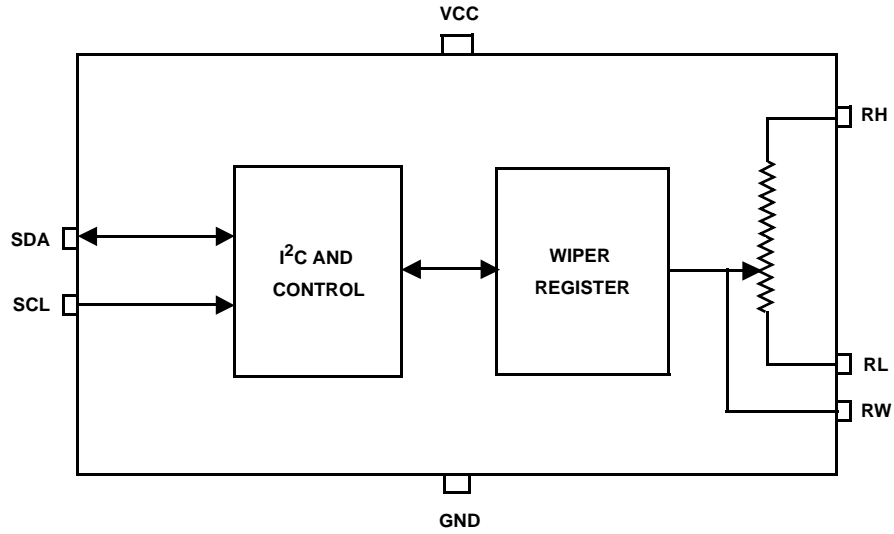

Pin Descriptions

MSOP PIN	SYMBOL	DESCRIPTION
1	NC	No connection
2	SCL	I ² C interface clock
3	SDA	Serial data I/O for the I ² C interface
4	GND	Ground
5	RW	"Wiper" terminal of the DCP
6	RL	"Low" terminal of the DCP
7	RH	"High" terminal of the DCP
8	V _{CC}	Power supply

Equivalent Circuitry

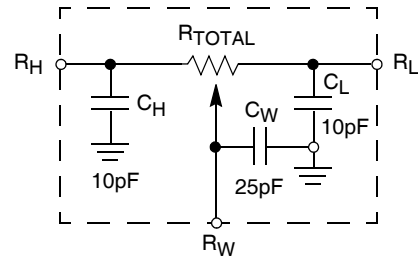

Absolute Maximum Ratings

Storage Temperature -65°C to +150°C
 Voltage at Any Digital Interface Pin
 With Respect to V_{SS} -0.3V to V_{CC}+0.3V
 V_{CC} -0.3V to +6V
 Voltage at Any DCP Pin With
 Respect to V_{SS} -0.3V to V_{CC}
 Lead Temperature (Soldering, 10s) +300°C
 I_W (10s) ±6mA
 Latchup Class II, Level A @ +105°C
 ESD
 HBM 6kV
 MM 500V

Thermal Information

Thermal Resistance (Typical, Note 1) θ_{JA} (°C/W)
 8 Ld MSOP Package 130
 Maximum Junction Temperature (Plastic Package) +150°C

Recommended Operating Conditions

Industrial -40°C to +85°C
 Automotive -40°C to +105°C
 V_{CC} 2.7V to 5.5V
 Power Rating 5mW
 Wiper Current ±3.0mA

CAUTION: Stresses above those listed in "Absolute Maximum Ratings" may cause permanent damage to the device. This is a stress only rating and operation of the device at these or any other conditions above those indicated in the operational sections of this specification is not implied.

NOTES:

1. θ_{JA} is measured with the component mounted on a high effective thermal conductivity test board in free air. See Tech Brief TB379 for details.

Analog Specifications Over recommended operating conditions unless otherwise stated.

SYMBOL	PARAMETER	TEST CONDITIONS	MIN	TYP (Notes 2)	MAX	UNIT
R _{TOTAL}	R _H to R _L Resistance	W, U versions respectively		10, 50		kΩ
	R _H to R _L Resistance Tolerance		-20		+20	%
R _W	Wiper resistance	V _{CC} = 3.3V @ +25°C Wiper current = V _{CC} /R _{TOTAL}		70	200	Ω
C _H /C _L /C _W	Potentiometer Capacitance (Note 14, Equivalent circuitry)			10/10/25		pF
I _{LkgDCP}	Leakage on DCP pins (Note 14)	Voltage at pin from GND to V _{CC}		0.1	1	μA
VOLTAGE DIVIDER MODE (0V @ R _L ; V _{CC} @ R _H ; measured at R _W , unloaded)						
INL (Note 7)	Integral Non-Linearity		-1		1	LSB (Note 3)
DNL (Note 6)	Differential Non-Linearity	Monotonic over all tap positions	W option	-0.75	+0.75	LSB (Note 3)
			U option	-0.5	+0.5	LSB (Note 3)
ZSerror (Note 4)	Zero-Scale Error	W option	0	1	7	LSB (Note 3)
		U option	0	0.5	2	
FSerror (Note 5)	Full-Scale Error	W option	-7	-1	0	LSB (Note 3)
		U option	-2	-0.5	0	
TC _V (Notes 8, 14)	Ratiometric Temperature Coefficient	DCP Register set to 80 hex		±4		ppm/°C
RESISTOR MODE (Measurements between R _W and R _L with R _H not connected, or between R _W and R _H with R _L not connected)						
RINL (Note 12)	Integral Non-Linearity	DCP register set between 20 hex and FF hex. Monotonic over all tap positions	-1		1	MI (Note 9)
RDNL (Note 6)	Differential Non-Linearity	DCP register set between 20 hex and FF hex. Monotonic over all tap positions	W option	-0.75	+0.75	MI (Note 9)
			U option	-0.5	+0.5	MI (Note 9)
Roffset (Note 10)	Offset	W option	0	1	7	MI (Note 9)
		U option	0	0.5	2	MI (Note 9)
TC _R (Notes 13, 14)	Resistance Temperature Coefficient	DCP register set between 20 hex and FF hex		±35		ppm/°C

Operating Specifications Over the recommended operating conditions unless otherwise specified.

SYMBOL	PARAMETER	TEST CONDITIONS	MIN	TYP (Note 1)	MAX	UNITS
I _{CC1}	V _{CC} Supply Current (Volatile Write/Read)	f _{SCL} = 400kHz; SDA = Open; (for I ² C, Active, Read and Volatile Write States only)		20	100	μA
I _{SB}	V _{CC} Current (Standby)	V _{CC} = +5.5V, I ² C Interface in Standby State, Temperature range from -40°C to +85°C		2	5	μA
		V _{CC} = +5.5V, I ² C Interface in Standby State, Temperature range from -40°C to +105°C		2	8	μA
		V _{CC} = +3.6V, I ² C Interface in Standby State, Temperature range from -40°C to +85°C		0.8	2	μA
		V _{CC} = +3.6V, I ² C Interface in Standby State, Temperature range from -40°C to +105°C		0.8	5	μA
I _{LkgDig}	Leakage Current at Pins SDA and SCL	Voltage at pin from GND to V _{CC}	-10		10	μA
t _{DCP} (Note 14)	DCP Wiper Response Time	SCL falling edge of last bit of DCP Data Byte to wiper change			1	μs
V _{por}	Power-On Recall Voltage	Minimum V _{CC} at which memory recall occurs	1.8		2.6	V
V _{CC} Ramp	V _{CC} Ramp Rate		0.2			V/ms
t _D (Note 14)	Power-Up Delay	V _{CC} above V _{por} , to DCP Initial Value Register recall completed, and I ² C Interface in standby state			3	ms

SERIAL INTERFACE SPECIFICATIONS

V _{IL}	SDA, and SCL Input Buffer LOW Voltage		-0.3		0.3*V _{CC}	V
V _{IH}	SDA, and SCL Input Buffer HIGH Voltage		0.7*V _{CC}		V _{CC} +0.3	V
Hysteresis (Note 14)	SDA and SCL Input Buffer Hysteresis		0.05*V _{CC}			V
V _{OL} (Note 14)	SDA Output Buffer LOW Voltage, Sinking 4mA		0		0.4	V
C _{pin} (Note 14)	SDA, and SCL Pin Capacitance				10	pF
f _{SCL}	SCL Frequency				400	kHz
t _{IN} (Note 14)	Pulse Width Suppression Time at SDA and SCL Inputs	Any pulse narrower than the max spec is suppressed.			50	ns
t _{AA} (Note 14)	SCL Falling Edge to SDA Output Data Valid	SCL falling edge crossing 30% of V _{CC} , until SDA exits the 30% to 70% of V _{CC} window.			900	ns
t _{BUF} (Note 14)	Time the Bus Must be Free Before the Start of a New Transmission	SDA crossing 70% of V _{CC} during a STOP condition, to SDA crossing 70% of V _{CC} during the following START condition.	1300			ns
t _{LOW}	Clock LOW Time	Measured at the 30% of V _{CC} crossing.	1300			ns
t _{HIGH}	Clock HIGH Time	Measured at the 70% of V _{CC} crossing.	600			ns
t _{SU:STA}	START Condition Setup Time	SCL rising edge to SDA falling edge. Both crossing 70% of V _{CC} .	600			ns
t _{HD:STA}	START Condition Hold Time	From SDA falling edge crossing 30% of V _{CC} to SCL falling edge crossing 70% of V _{CC} .	600			ns
t _{SU:DAT}	Input Data Setup Time	From SDA exiting the 30% to 70% of V _{CC} window, to SCL rising edge crossing 30% of V _{CC}	100			ns
t _{HD:DAT}	Input Data Hold Time	From SCL rising edge crossing 70% of V _{CC} to SDA entering the 30% to 70% of V _{CC} window.	0			ns
t _{SU:STO}	STOP Condition Setup Time	From SCL rising edge crossing 70% of V _{CC} , to SDA rising edge crossing 30% of V _{CC} .	600			ns

Operating Specifications Over the recommended operating conditions unless otherwise specified. (Continued)

SYMBOL	PARAMETER	TEST CONDITIONS	MIN	TYP (Note 1)	MAX	UNITS
t _{HD:STO}	STOP Condition Hold Time for Read, or Volatile Only Write	From SDA rising edge to SCL falling edge. Both crossing 70% of V _{CC} .	600			ns
t _{DH} (Note 14)	Output Data Hold Time	From SCL falling edge crossing 30% of V _{CC} , until SDA enters the 30% to 70% of V _{CC} window.	0			ns
t _R (Note 14)	SDA and SCL Rise Time	From 30% to 70% of V _{CC}	20 + 0.1 * C _b		250	ns
t _F (Note 14)	SDA and SCL Fall Time	From 70% to 30% of V _{CC}	20 + 0.1 * C _b		250	ns
C _b (Note 14)	Capacitive Loading of SDA or SCL	Total on-chip and off-chip	10		400	pF
R _{pu} (Note 14)	SDA and SCL Bus Pull-Up Resistor Off-Chip	Maximum is determined by t _R and t _F . For C _b = 400pF, max is about 2~2.5kΩ. For C _b = 40pF, max is about 15~20kΩ	1			kΩ

SDA vs SCL Timing

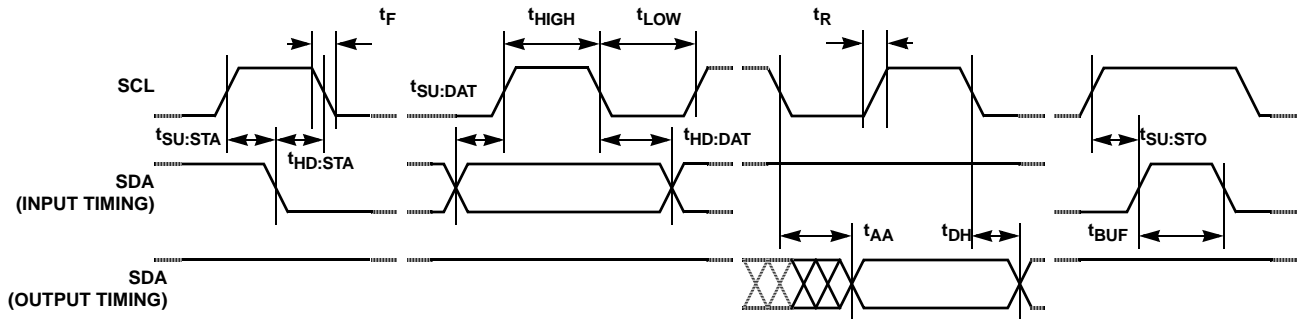

NOTES:

- Typical values are for T_A = +25°C and 3.3V supply voltage.
- LSB: $[V(RW)_{255} - V(RW)_0]/255$. V(RW)₂₅₅ and V(RW)₀ are V(RW) for the DCP register set to FF hex and 00 hex respectively. LSB is the incremental voltage when changing from one tap to an adjacent tap.
- ZS error = V(RW)₀/LSB.
- FS error = $[V(RW)_{255} - V_{CC}]/LSB$.
- DNL = $[V(RW)_i - V(RW)_{i-1}]/LSB - 1$, for i = 1 to 255. i is the DCP register setting.
- INL = $(V(RW)_i - i \cdot LSB - V(RW)_0)/LSB$, for i = 1 to 255.
- $TC_V = \frac{\text{Max}(V(RW)_i) - \text{Min}(V(RW)_i)}{[\text{Max}(V(RW)_i) + \text{Min}(V(RW)_i)]/2} \times \frac{10^6}{145^\circ\text{C}}$ for i = 16 to 240 decimal, T = -40°C to +105°C. Max() is the maximum value of the wiper voltage and Min() is the minimum value of the wiper voltage over the temperature range.
- MI = $|R_{255} - R_0|/255$. R₂₅₅ and R₀ are the measured resistances for the DCP register set to FF hex and 00 hex respectively. Roffset = R₀/MI, when measuring between RW and RL.
- Roffset = R₂₅₅/MI, when measuring between RW and RH.
- RDNL = $(R_i - R_{i-1})/MI$, for i = 32 to 255.
- RINL = $[R_i - (MI \cdot i) - R_0]/MI$, for i = 32 to 255.
- $TC_R = \frac{[\text{Max}(R_i) - \text{Min}(R_i)]}{[\text{Max}(R_i) + \text{Min}(R_i)]/2} \times \frac{10^6}{145^\circ\text{C}}$ for i = 32 to 255, T = -40°C to +105°C. Max() is the maximum value of the resistance and Min() is the minimum value of the resistance over the temperature range.
- This parameter is not 100% tested.

Typical Performance Curves

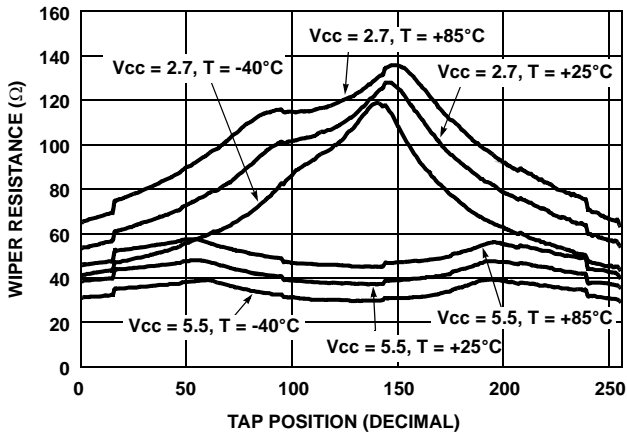

FIGURE 1. WIPER RESISTANCE vs TAP POSITION [I(RW) = V_{CC}/R_{total}] FOR 50kΩ (U)

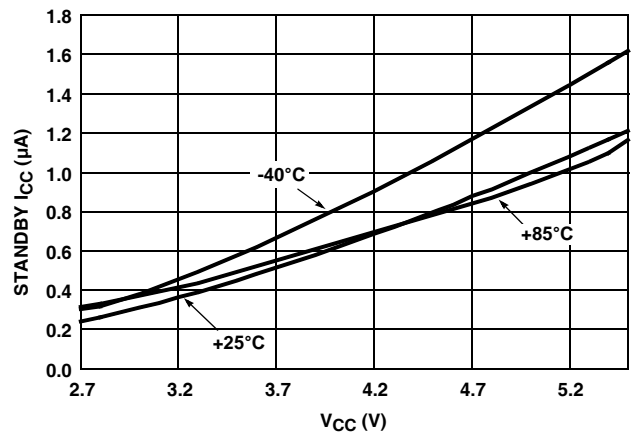

FIGURE 2. STANDBY I_{CC} vs V_{CC}

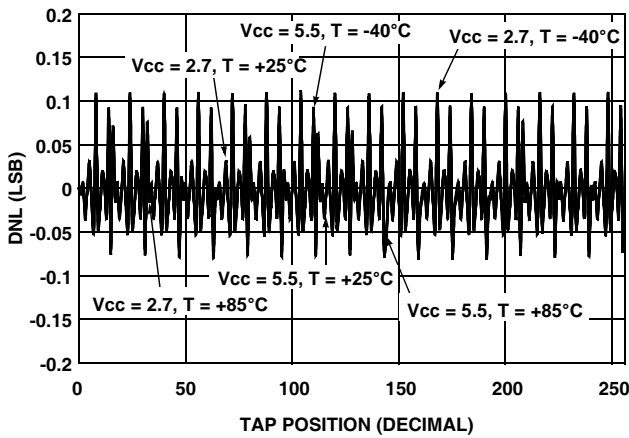

FIGURE 3. DNL vs TAP POSITION IN VOLTAGE DIVIDER MODE FOR 10kΩ (W)

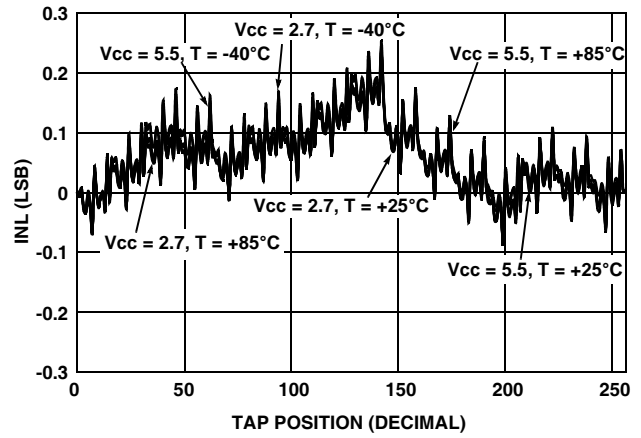

FIGURE 4. INL vs TAP POSITION IN VOLTAGE DIVIDER MODE FOR 10kΩ (W)

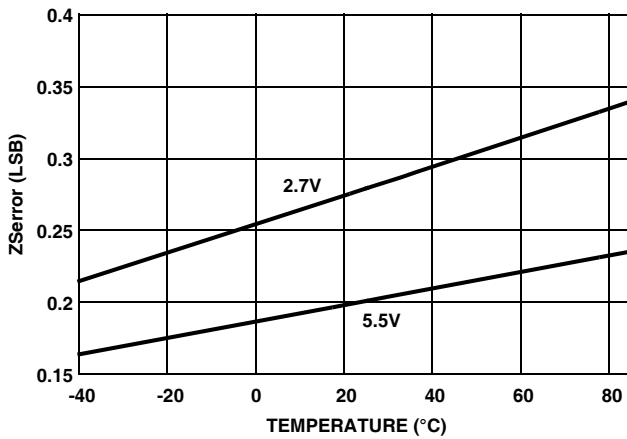

FIGURE 5. ZSerror vs TEMPERATURE

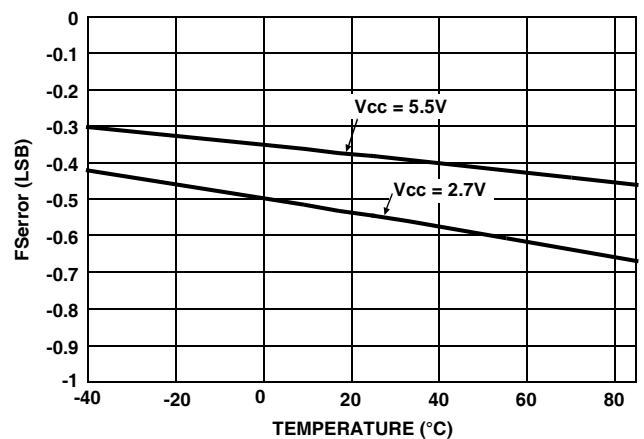

FIGURE 6. FSerror vs TEMPERATURE

Typical Performance Curves (Continued)

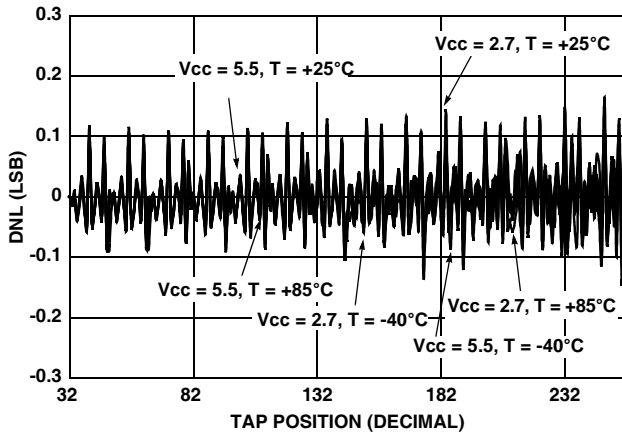

FIGURE 7. DNL vs TAP POSITION IN RHEOSTAT MODE FOR 50kΩ (U)

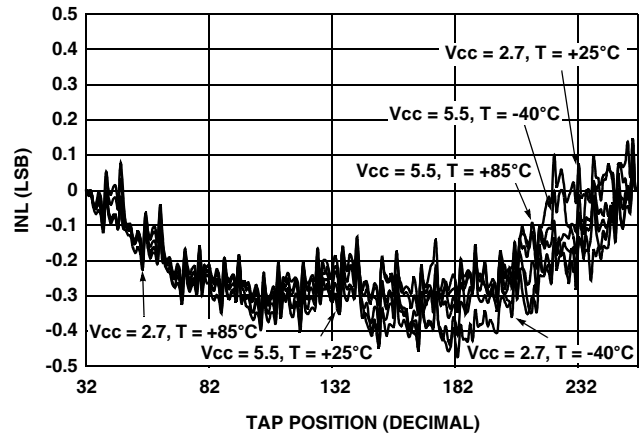

FIGURE 8. INL vs TAP POSITION IN RHEOSTAT MODE FOR 50kΩ (U)

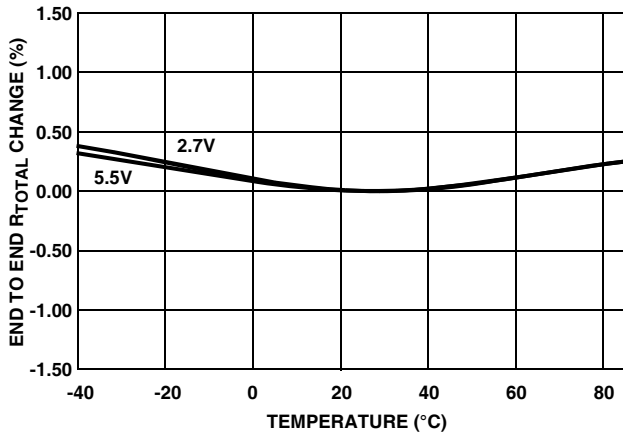

FIGURE 9. END TO END R_{TOTAL} % CHANGE vs TEMPERATURE

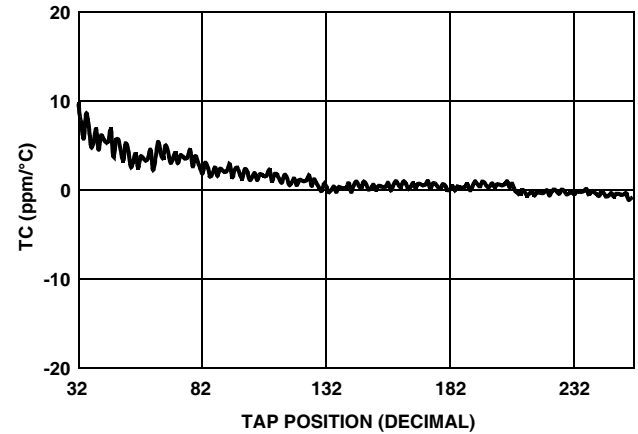

FIGURE 10. TC FOR VOLTAGE DIVIDER MODE IN ppm

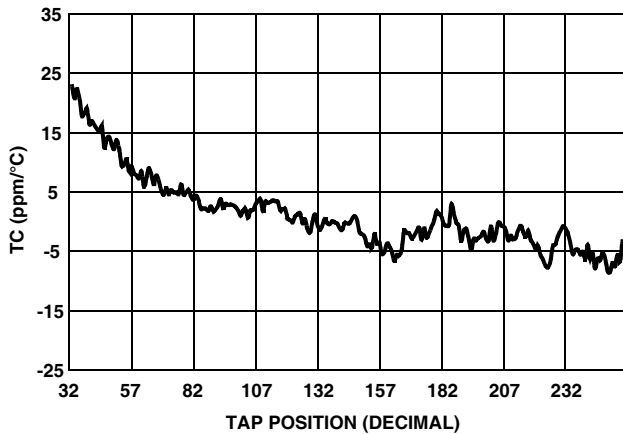

FIGURE 11. TC FOR RHEOSTAT MODE IN ppm

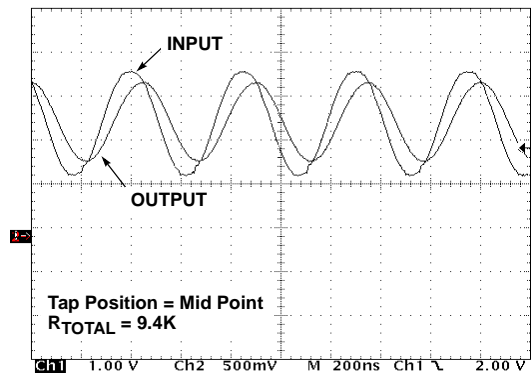

FIGURE 12. FREQUENCY RESPONSE (2.2MHz)

Typical Performance Curves (Continued)

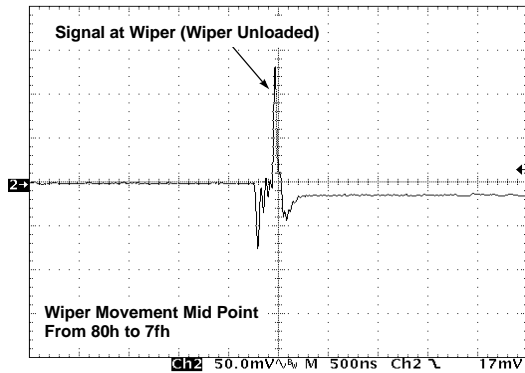

FIGURE 13. MIDSCALE GLITCH, CODE 80h TO 7Fh (WIPER 0)

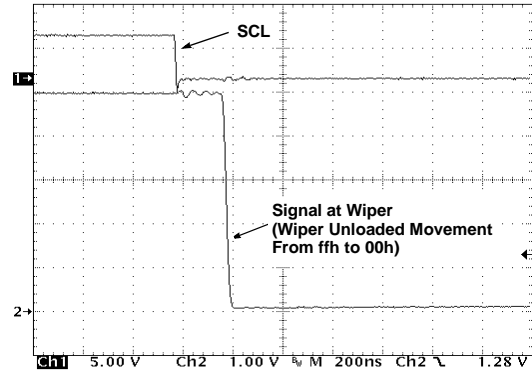

FIGURE 14. LARGE SIGNAL SETTLING TIME

Principles of Operation

The ISL90810 is an integrated circuit incorporating one DCP with its associated registers, and an I²C serial interface providing direct communication between a host and the potentiometer.

DCP Description

The DCP is implemented with a combination of resistor elements and CMOS switches. The physical ends of the DCP are equivalent to the fixed terminals of a mechanical potentiometer (RH and RL pins). The RW pin of the DCP is connected to intermediate nodes, and is equivalent to the wiper terminal of a mechanical potentiometer. The position of the wiper terminal within the DCP is controlled by an 8-bit volatile Wiper Register (WR). When the WR of the DCP contains all zeroes (WR[7:0]: 00h), its wiper terminal (RW) is closest to its “Low” terminal (RL). When the WR of the DCP contains all ones (WR[7:0]: FFh), its wiper terminal (RW) is closest to its “High” terminal (RH). As the value of the WR increases from all zeroes (0 decimal) to all ones (255 decimal), the wiper moves monotonically from the position closest to RL to the closest to RH. At the same time, the resistance between RW and RL increases monotonically, while the resistance between RH and RW decreases monotonically.

While the ISL90810 is being powered up, The WR is reset to 80h (128 decimal), which locates RW roughly at the center between RL and RH.

The WR can be read or written to directly using the I²C serial interface as described in the following sections. The I²C interface Address Byte has to be set to 00hex to access the WR.

I²C Serial Interface

The ISL90810 supports a bidirectional bus oriented protocol. The protocol defines any device that sends data onto the bus as a transmitter and the receiving device as the receiver. The device controlling the transfer is a master and the device being controlled is the slave. The master always initiates data transfers and provides the clock for both transmit and receive operations. Therefore, the ISL90810 operates as a slave device in all applications.

All communication over the I²C interface is conducted by sending the MSB of each byte of data first.

Protocol Conventions

Data states on the SDA line must change only during SCL LOW periods. SDA state changes during SCL HIGH are reserved for indicating START and STOP conditions (See Figure 15). On power-up of the ISL90810 the SDA pin is in the input mode.

All I²C interface operations must begin with a START condition, which is a HIGH to LOW transition of SDA while SCL is HIGH. The ISL90810 continuously monitors the SDA and SCL lines for the START condition and does not respond to any command until this condition is met (See Figure 15). A START condition is ignored during the power-up for the device.

All I²C interface operations must be terminated by a STOP condition, which is a LOW to HIGH transition of SDA while SCL is HIGH (See Figure 15) A STOP condition at the end of a read operation, or at the end of a write operation places the device in its standby mode.

An acknowledge (ACK) is a software convention used to indicate a successful data transfer. The transmitting device, either master or slave, releases the SDA bus after transmitting eight bits. During the ninth clock cycle, the receiver pulls the SDA line LOW to acknowledge the reception of the eight bits of data (See Figure 16).

The ISL90810 responds with an ACK after recognition of a START condition followed by a valid Identification Byte, and once again after successful receipt of an Address Byte. The ISL90810 also responds with an ACK after receiving a Data Byte of a write operation. The master must respond with an ACK after receiving a Data Byte of a read operation.

A valid Identification Byte contains 0101000 as the seven MSBs. The LSB is the Read/Write bit. Its value is "1" for a Read operation, and "0" for a Write operation (See Table 1)

The address byte is set to 00h and follows the identification byte. Read and write operations always point to address 00h, indicating the WR for the device.

TABLE 1. IDENTIFICATION BYTE FORMAT

0	1	0	1	0	0	0	R/W
(MSB)							(LSB)

Write Operation

A Write operation requires a START condition, followed by a valid Identification Byte, a valid Address Byte, a Data Byte, and a STOP condition. After each of the three bytes, the ISL90810 responds with an ACK. At this time the device enters its standby state (See Figure 17).

Data Protection

A valid Identification Byte, Address Byte, and total number of SCL pulses act as a protection for the registers. During a Write sequence, the Data Byte is loaded into an internal shift register as it is received. The Data Byte is transferred to the Wiper Register (WR) at the falling edge of the SCL pulse that loads the last bit (LSB) of the Data Byte.

Read Operation

A Read operation consists of a three byte instruction followed by one Data Byte (See Figure 18). The master initiates the operation issuing the following sequence: a START, the identification byte with the R/W bit set to "0", an Address Byte, a second START, and a second Identification byte with the R/W bit set to "1". After each of the three bytes, the ISL90810 responds with an ACK. The the ISL90810 transmits Data Bytes as long as the master responds with an ACK during the SCL cycle following the eighth bit of each byte. The master terminates the read operation (issuing a ACK and a STOP condition) following the last bit of the Data Byte (See Figure 18).

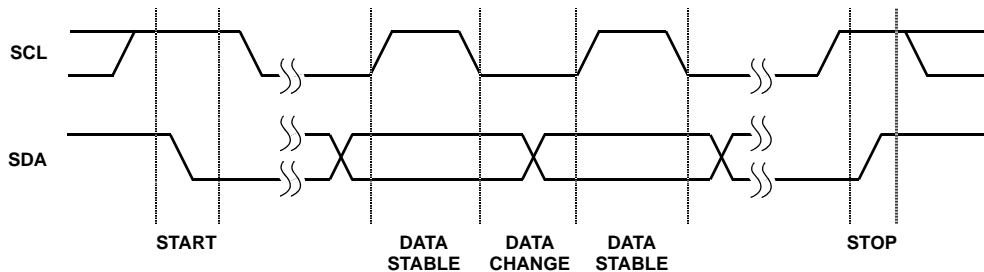

FIGURE 15. VALID DATA CHANGES, START, AND STOP CONDITIONS

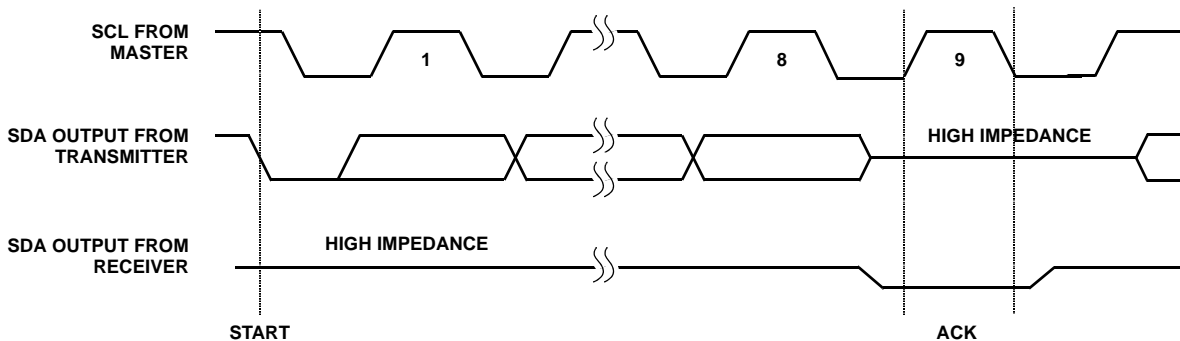

FIGURE 16. ACKNOWLEDGE RESPONSE FROM RECEIVER

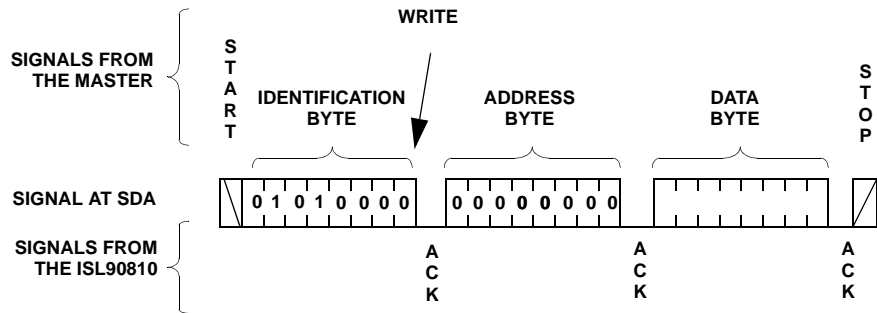

FIGURE 17. BYTE WRITE SEQUENCE

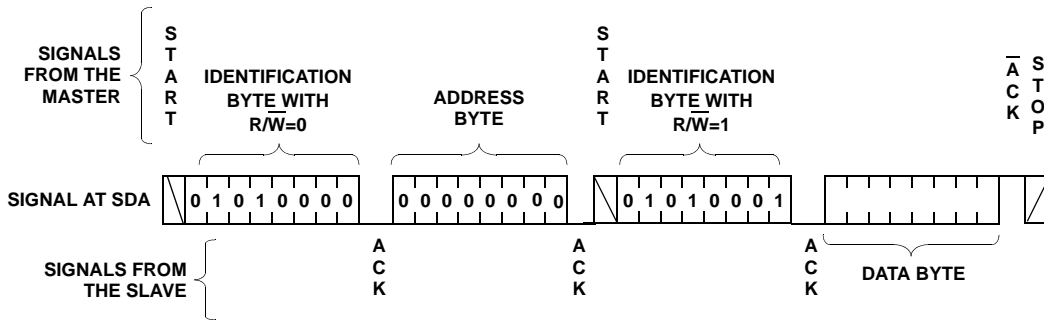
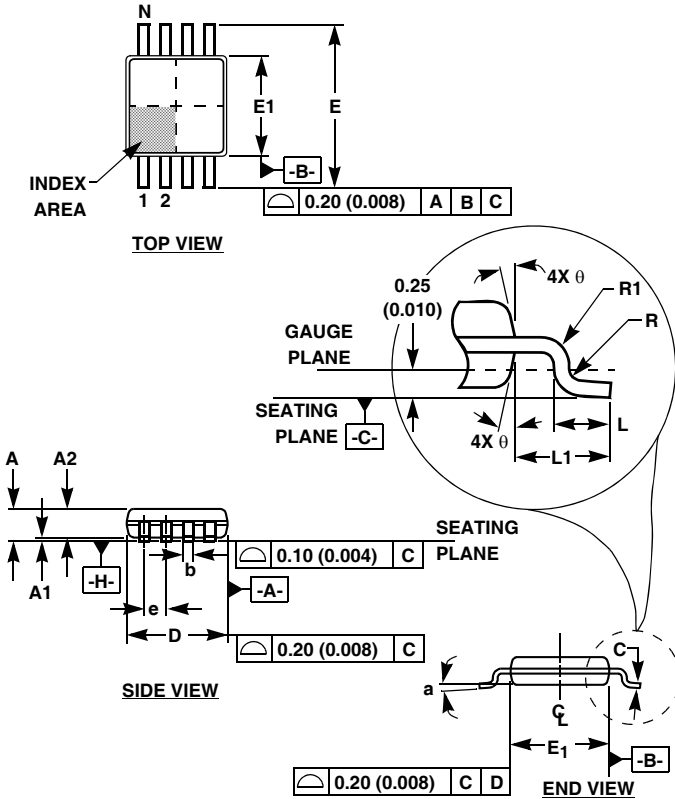

FIGURE 18. READ SEQUENCE

Mini Small Outline Plastic Packages (MSOP)



M8.118 (JEDEC MO-187AA)
8 LEAD MINI SMALL OUTLINE PLASTIC PACKAGE

SYMBOL	INCHES		MILLIMETERS		NOTES
	MIN	MAX	MIN	MAX	
A	0.037	0.043	0.94	1.10	-
A1	0.002	0.006	0.05	0.15	-
A2	0.030	0.037	0.75	0.95	-
b	0.010	0.014	0.25	0.36	9
c	0.004	0.008	0.09	0.20	-
D	0.116	0.120	2.95	3.05	3
E1	0.116	0.120	2.95	3.05	4
e	0.026 BSC		0.65 BSC		-
E	0.187	0.199	4.75	5.05	-
L	0.016	0.028	0.40	0.70	6
L1	0.037 REF		0.95 REF		-
N	8		8		7
R	0.003	-	0.07	-	-
R1	0.003	-	0.07	-	-
θ	5°	15°	5°	15°	-
α	0°	6°	0°	6°	-

Rev. 2 01/03

NOTES:

- These package dimensions are within allowable dimensions of JEDEC MO-187BA.
- Dimensioning and tolerancing per ANSI Y14.5M-1994.
- Dimension "D" does not include mold flash, protrusions or gate burrs and are measured at Datum Plane. Mold flash, protrusion and gate burrs shall not exceed 0.15mm (0.006 inch) per side.
- Dimension "E1" does not include interlead flash or protrusions and are measured at Datum Plane. [-H-] Interlead flash and protrusions shall not exceed 0.15mm (0.006 inch) per side.
- Formed leads shall be planar with respect to one another within 0.10mm (0.004) at seating Plane.
- "L" is the length of terminal for soldering to a substrate.
- "N" is the number of terminal positions.
- Terminal numbers are shown for reference only.
- Dimension "b" does not include dambar protrusion. Allowable dambar protrusion shall be 0.08mm (0.003 inch) total in excess of "b" dimension at maximum material condition. Minimum space between protrusion and adjacent lead is 0.07mm (0.0027 inch).
- Datums [-A-] and [-B-] to be determined at Datum plane [-H-].
- Controlling dimension: MILLIMETER. Converted inch dimensions are for reference only.

All Intersil U.S. products are manufactured, assembled and tested utilizing ISO9000 quality systems. Intersil Corporation's quality certifications can be viewed at www.intersil.com/design/quality

Intersil products are sold by description only. Intersil Corporation reserves the right to make changes in circuit design, software and/or specifications at any time without notice. Accordingly, the reader is cautioned to verify that data sheets are current before placing orders. Information furnished by Intersil is believed to be accurate and reliable. However, no responsibility is assumed by Intersil or its subsidiaries for its use; nor for any infringements of patents or other rights of third parties which may result from its use. No license is granted by implication or otherwise under any patent or patent rights of Intersil or its subsidiaries.

For information regarding Intersil Corporation and its products, see www.intersil.com