

# FMS6419

## Selectable RGB (YUV) HD/SD Video Filter Driver with Y, C, Composite Outputs

### Features

- Three channel video reconstruction filters
- YUV/RGB filters
- 2:1 Mux inputs for multiple RGB/YUV inputs
- Selectable 8MHz or 30MHz 6th order filters for RGB (YUV) applications
- 8MHz 6th order Y, C filters with composite summer
- DC coupled input, AC coupled output
- All outputs can drive AC coupled 150Ω loads and provide 6dB of gain
- Dual multiplexed inputs
- 0.6% differential gain with 0.2° differential phase
- 36dB/octave roll-off on all channels

### Description

The FMS6419 offers comprehensive filtering for set top box or DVD applications. This part consists of a triple 6th order filter with selectable 30MHz or 8MHz frequencies.

A 2-to-1 multiplexer is provided on each filter channel. The triple filters are intended for either YUV or RGB signals. All channels accept DC coupled ground-referenced 1V signals. The filters provide 2Vpp signals into AC coupled terminated loads. The low-pass filters are powered by 3.3V and the outputs by 5.0V.

### Applications

- Cable Set top boxes
- Satellite Set top boxes
- DVD players
- HDTV
- Personal Video Recorders (PVR)
- Video On Demand (VOD)

### Functional Block Diagram

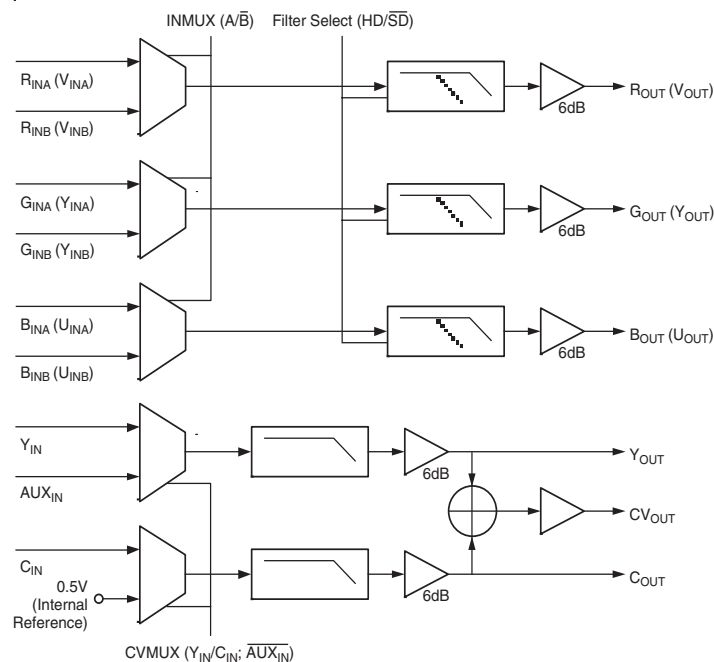

## Electrical Specifications

( $T_C = 25^\circ\text{C}$ ,  $V_i = 1V_{pp}$ ;  $V_{CCA} = 3.3V$ ,  $V_{CCO} = 5.0V$ , all inputs AC coupled with  $0.1\mu\text{F}$ , all outputs AC coupled with  $220\mu\text{F}$  into  $150\Omega$ , referenced to  $400\text{kHz}$ ; unless otherwise noted)

Symbol	Parameter	Conditions	Min	Typ	Max	Units
$I_{CCA}$	Supply Current <sup>1</sup>	$V_{CCA}$ no load	50	85	120	mA
$I_{CCO}$	Supply Current <sup>1</sup>	$V_{CCO}$ no load	50	85	120	mA
$V_i$	Input Voltage Max	Reference to ground		1.3		V
$V_{il}$	Digital Input Low <sup>1</sup>	$F_{SEL}$ , $IN_{MUX}$ , $CV_{MUX}$	0		0.8	V
$V_{ih}$	Digital Input High <sup>1</sup>	$F_{SEL}$ , $IN_{MUX}$ , $CV_{MUX}$	2.4		$V_{CCO}$	V
PSSR	PSSR (all channels)	DC		-40		dB

## Standard Definition Electrical Specifications

( $T_C = 25^\circ\text{C}$ ,  $V_i = 1V_{pp}$ ;  $V_{CCA} = 3.3V$ ,  $V_{CCO} = 5.0V$ ,  $F_{SEL} = 0$ , all inputs AC coupled with  $0.1\mu\text{F}$ , all outputs AC coupled with  $220\mu\text{F}$  into  $150\Omega$ , referenced to  $400\text{kHz}$ ; unless otherwise noted)

Symbol	Parameter	Conditions	Min	Typ	Max	Units
$AV_{RGBSD}$	RGB SD Gain <sup>1</sup>	R,G,B channels SD Mode	5.65	6.0	6.35	dB
$AV_{YC}$	Y,C,CV Gain <sup>1</sup>	Y,C,CV channels	5.65	6.0	6.35	dB
$f_{1dBSD}$	-1dB Bandwidth for SD <sup>1</sup>	R,G,B,Y,C,CV channels	4	6.0		MHz
$f_{CSD}$	-3dB Bandwidth for SD <sup>1</sup>	R,G,B,Y,C,CV channels	6.7	8.2		MHz
$f_{SBSD}$	Attenuation: SD (stopband reject) <sup>1</sup>	R,G,B,Y,C channels at $f = 27\text{MHz}$	37	55		dB
$f_{SBCV}$	Attenuation: SD (stopband reject) <sup>1</sup>	CV channel at $f = 27\text{MHz}$	37	55		dB
dG	Differential Gain	R,G,B,Y,C,CV channels		0.6		%
d $\phi$	Differential Phase	R,G,B,Y,C,CV channels		0.2		°
$X_{TALKYC}$	Crosstalk (channel-to-channel)	at 1MHz		-64		dB
$X_{TALKRGB}$	Crosstalk (channel-to-channel)	at 1MHz		-70		dB
$IN_{MUXISO}$	$IN_{MUX}$ Isolation	at 1MHz		-70		dB
SNR	Signal-to-Noise Ratio	R,G,B,Y,C,CV channels, NTC-7 weighting 4.2MHz lowpass, 100kHz highpass		70		dB
$t_{pdSD}$	Prop Delay for SD	Delay from input to output at 4.5MHz		80		ns
$t_{CLDCV}$	Chroma-Luma Delay $CV_{OUT}$ <sup>1</sup>	$f = 3.58\text{MHz}$ (referenced to 400kHz)	-35	2	35	ns
$t_{CLGCV}$	Chroma-Luma Gain $CV_{OUT}$ <sup>1</sup>	$f = 3.58\text{MHz}$ (referenced to 400kHz)	98	102	106	%

### Notes:

1. 100% tested at  $25^\circ\text{C}$ .

### General Note:

Peaking capacitor increases CV output at 4.2MHz nominally by 0.7dB.

## High Definition Electrical Specifications

( $T_C = 25^\circ\text{C}$ ,  $V_i = 1V_{pp}$ ;  $V_{CCA} = 3.3V$ ,  $V_{CCO} = 5.0V$ ,  $F_{SEL} = 1$ , all inputs AC coupled with  $0.1\mu\text{F}$ , all outputs AC coupled with  $220\mu\text{F}$  into  $150\Omega$ , referenced to  $400\text{kHz}$ ; unless otherwise noted)

Symbol	Parameter	Conditions	Min	Typ	Max	Units
$AV_{\text{RGBHD}}$	RGB HD Gain <sup>1</sup>	R,G,B channels HD Mode	5.65	6.0	6.35	dB
$f_{1\text{dBHD}}$	-1dB Bandwidth for HD <sup>1</sup>	R,G,B channels	20	26		MHz
$f_{\text{CHD}}$	-3dB Bandwidth for HD <sup>1</sup>	R,G,B channels	30	32		MHz
$f_{\text{SBHD}}$	Attenuation: HD (stopband reject) <sup>1</sup>	R,G,B channels at $f = 74.25\text{MHz}$	35	40		dB
$X_{\text{TALKRGB}}$	Crosstalk (channel-to-channel)	at 1MHz		-70		dB
$IN_{\text{MUXISO}}$	$IN_{\text{MUX}}$ Isolation	at 1MHz		-70		dB
SNR	Signal-to-Noise Ratio	R,G,B channels		70		dB
$t_{\text{pdHD}}$	Prop Delay for HD	Delay from input to output at 20MHz		30		ns

### Note:

- 100% tested at  $25^\circ\text{C}$ .

## Absolute Maximum Ratings (beyond which the device may be damaged)

Parameter	Min	Max	Units
Supply Voltage	-0.3	6	V
Analog and Digital I/O	-0.3	$V_{\text{CCO}} + 0.3$	V
Output Current Any One Channel (Do Not Exceed)		120	mA

### Note

Functional operation under any of these conditions is NOT implied. Performance and reliability are guaranteed only if operating conditions are not exceeded.

## Reliability Information

Parameter	Min	Typ	Max	Units
Junction Temperature			+150	$^\circ\text{C}$
Storage Temperature Range	-65		+150	$^\circ\text{C}$
Lead Temperature (Soldering, 10s)			+300	$^\circ\text{C}$
Thermal Resistance ( $\theta_{\text{JA}}$ ), JEDEC Standard, Multi-layer Test Boards, Still Air		47		$^\circ\text{C/W}$

## Recommended Operating Conditions

Parameter	Min	Typ	Max	Units
Operating Temperature Range	0		70	$^\circ\text{C}$
$V_{\text{CCO}}$ Range	4.75	5.0	5.25	V
$V_{\text{CCA}}$ Range	3.135	3.3	3.465	V

## Standard Definition Typical Performance Characteristics

( $T_C = 25^\circ\text{C}$ ,  $V_i = 1V_{pp}$ ;  $V_{CCA} = 3.3V$ ,  $V_{CCO} = 5.0V$ ,  $F_{SEL} = 0$ , all inputs AC coupled with  $0.1\mu\text{F}$ , all outputs AC coupled with  $220\mu\text{F}$  into  $150\Omega$ , referenced to  $400\text{kHz}$ ; unless otherwise noted)

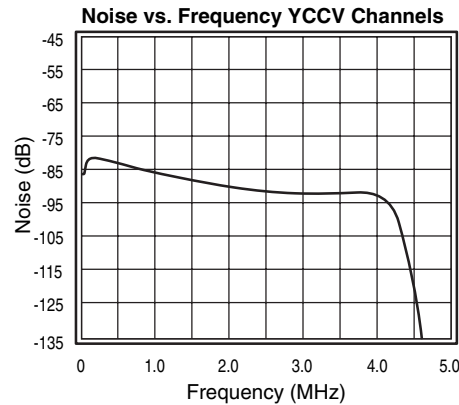
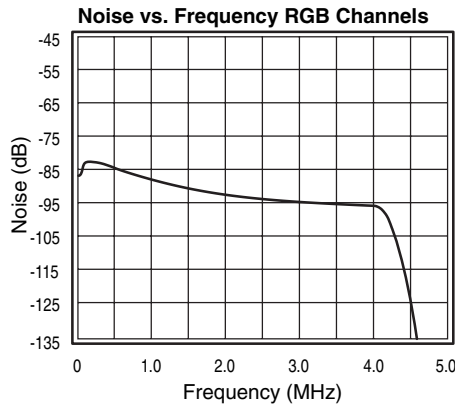
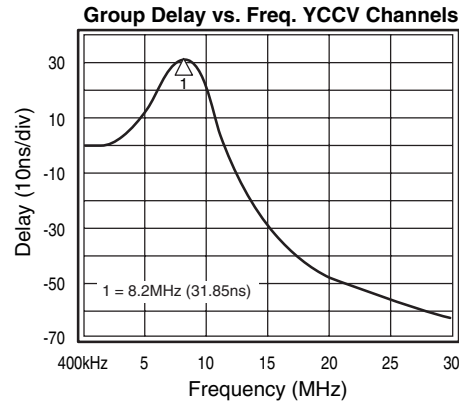
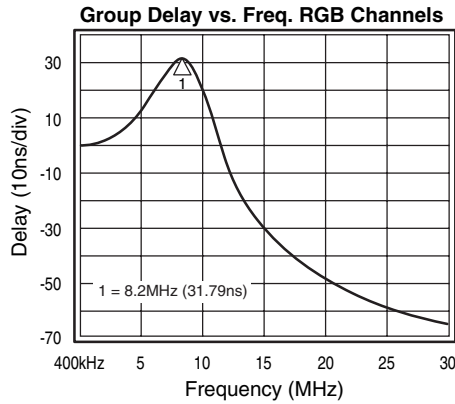
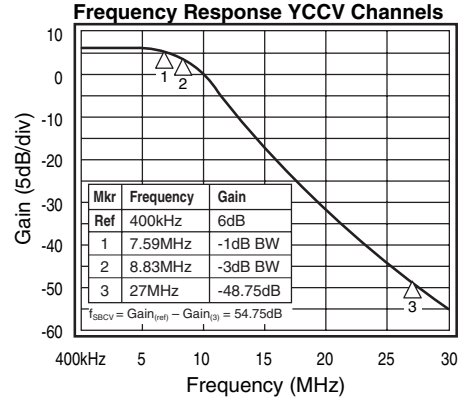
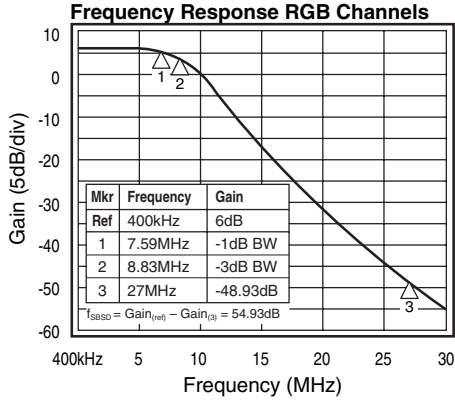

### Standard Definition Typical Performance Characteristics

( $T_C = 25^\circ\text{C}$ ,  $V_i = 1V_{pp}$ ;  $V_{CCA} = 3.3V$ ,  $V_{CCO} = 5.0V$ ,  $F_{SEL} = 0$ , all inputs AC coupled with  $0.1\mu\text{F}$ , all outputs AC coupled with  $220\mu\text{F}$  into  $150\Omega$ , referenced to  $400\text{kHz}$ ; unless otherwise noted)

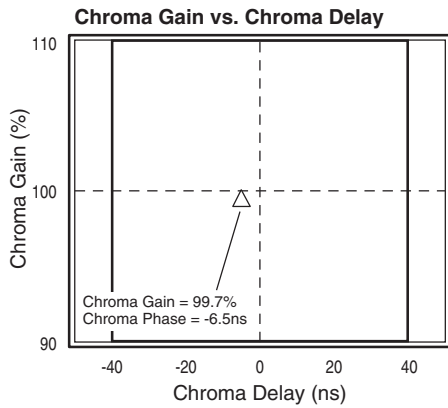
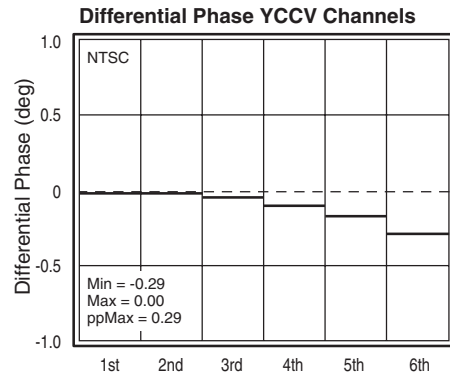
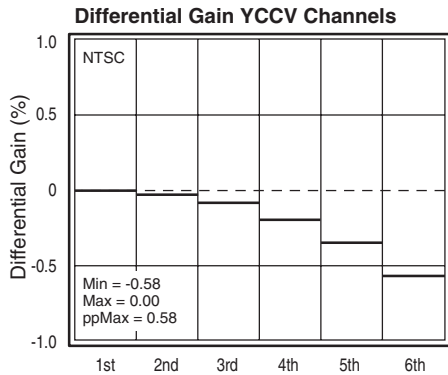
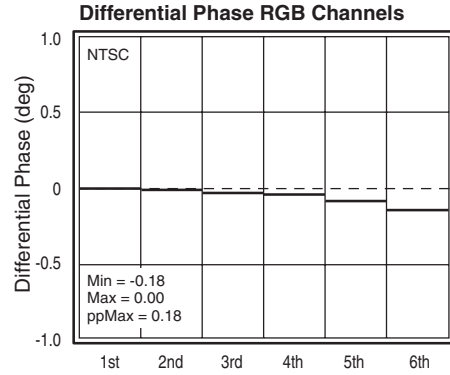
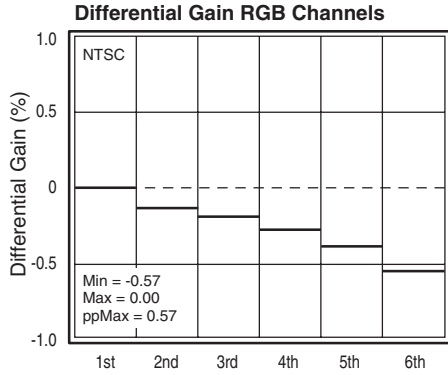

## High Definition Typical Performance Characteristics

( $T_C = 25^\circ\text{C}$ ,  $V_i = 1V_{pp}$ ;  $V_{CCA} = 3.3V$ ,  $V_{CCO} = 5.0V$ ,  $F_{SEL} = 1$ , all inputs AC coupled with  $0.1\mu\text{F}$ , all outputs AC coupled with  $220\mu\text{F}$  into  $150\Omega$ , referenced to  $400\text{kHz}$ ; unless otherwise noted)

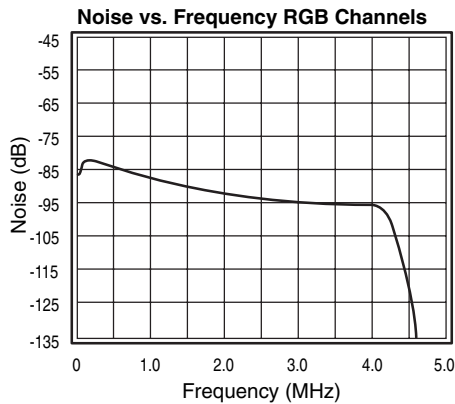
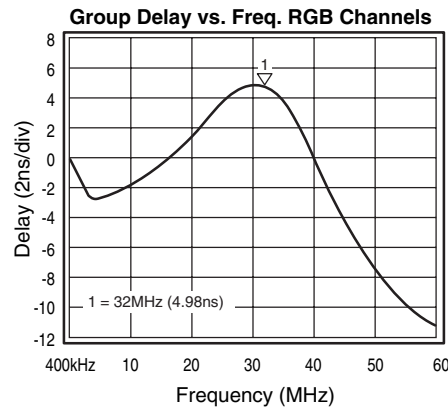
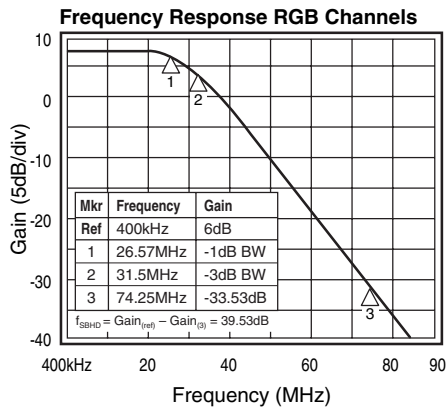

## General Description

The FMS6419 offers comprehensive filtering for set top box or DVD applications. This part consists of triple 6th order filters with selectable 30MHz or 8MHz frequencies and a dual filter for filtering Y, C with a composite summer. 2 to 1 multiplexers are provided on the triple filters as well as provisions for auxiliary input to the composite channel. The triple filters are intended for either YUV or RGB signals. All channels accept DC coupled ground-referenced 1V signals. The filters outputs 2Vpp signals into AC coupled terminated loads. The low-pass filters are powered by 3.3V and output buffers are powered by 5.0V.

The FMS6419 is a next generation filter solution from Fairchild Semiconductor addressing the expanding filtering needs for set top boxes, and DVD players. The product provides selectable filtering from 30MHz to 8MHz on the RGB channels. Thus, the FMS6419 addresses the requirement for a single set top box to be compatible with a variety of resolution standards. Additionally, the product provides

additional filters for Y, C, and Composite Video (CV) outputs. Multiplexers on the RGB and CV channels provide further flexibility.

For DVD applications, the product provides filtering and output drive amplification for 6 channels of outputs. These include R, G, B, Y, C, and CV outputs.

For Set top boxes, this product provides for 2 channels of video to be filtered, as well as the flexibility of selectable high order filtering for multiple resolution standards. Additional flexibility is provided by the Y (Luma) and C (Chroma) filters with a composite summer.

All channels provide 6dB gain, accept 1V ground referenced inputs, and drive AC coupled loads. The filters for the R, G, B, Y, C, and CV channels are powered from a 3.3V supply and the outputs from 5V.

## Applications

### DC Levels

At any given time, the input signal's DC levels must be between 0.0V and 1.3V to utilize the optimal headroom and to avoid clipping on the outputs. The Y channel should nominally have the Sync Tip at ground and be a 1V signal. The C channel should ride around the 0.5V level. This will ensure that the filter will utilize the optimal headroom and avoid clipping.

### DC Coupled Output Applications

The 220 $\mu$ F capacitor coupled with the 150 $\Omega$  termination forms a high pass filter that blocks the DC while passing the video frequencies and avoiding tilt. Lower values such as

10 $\mu$ F would create a problem. By AC coupling, the average DC level is zero. Thus, the output voltages of all channels will be centered around zero. Alternately, DC coupling the output of the FMS6419 is allowable, but not recommended. There are several tradeoffs: The average DC level on the outputs will be 2V. Each output will dissipate an additional 40mW nominally. The application will need to accommodate a 1V DC offset sync tip. Also, it is recommended to limit one 150 $\Omega$  load per output.

### Driving the Digital Pins with 3.3V or 5V Logic

Either is allowed as long as the  $V_{ih}$  and  $V_{il}$  are adhered to.

## Pin Configuration

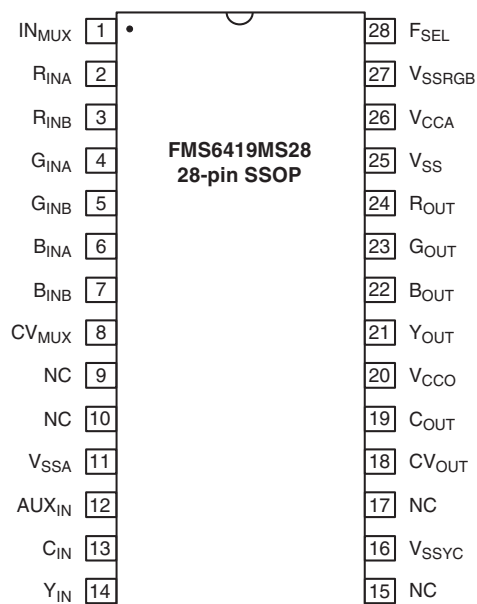

#### Note:

Pin Assignments table follows on page 8.

### Pin Assignments

Pin #	Pin Name	Pin Voltage	Description	Equivalent Circuit
1	IN <sub>MUX</sub>		Logic input selects between channel <A> or <B> of the RGB inputs. (1): RGB A input, (0): RGB B input	
8	CV <sub>MUX</sub>		Logic input pin selects between the Y <sub>IN</sub> or AUX <sub>IN</sub> inputs as well as enabling or disabling C <sub>IN</sub> . (1): Y <sub>IN</sub> /C <sub>IN</sub> , (0): AUX <sub>IN</sub>	
28	F <sub>SEL</sub>		Logic Input selects between (0) SD (8.0MHz) and (1) HD (30.0MHz) filters	
2	R <sub>INA</sub>		Analog RED video input - Channel A	
3	R <sub>INB</sub>		Analog RED video input - Channel B	
4	G <sub>INA</sub>		Analog GREEN video input - Channel A	
5	G <sub>INB</sub>		Analog GREEN video input - Channel B	
6	B <sub>INA</sub>		Analog BLUE video input - Channel A	
7	B <sub>INB</sub>		Analog BLUE video input - Channel B	
12	AUX <sub>IN</sub>		Analog Composite Video Input	
13	C <sub>IN</sub>		Analog Chroma Video Input	
14	Y <sub>IN</sub>		Analog Luma Video Input	
9, 10, 15, 17	N/C		No Connect (float pin)	
26	V <sub>CCA</sub>		+3.3V power supply for filters	
20	V <sub>CCO</sub>		+5V power supply for output buffers	
18	CV <sub>OUT</sub>		Filtered Analog-Composite Video output	
19	C <sub>OUT</sub>		Filtered Analog-Chroma Video output	
21	Y <sub>OUT</sub>		Filtered Analog-Luma Video output	
22	B <sub>OUT</sub>		Filtered Analog BLUE video output from either B <sub>INA</sub> or B <sub>INB</sub>	
23	G <sub>OUT</sub>		Filtered Analog GREEN video output from either G <sub>INA</sub> or G <sub>INB</sub>	
24	R <sub>OUT</sub>		Filtered Analog RED video output from either R <sub>INA</sub> or R <sub>INB</sub>	
25	V <sub>SS</sub>		Ground	
11	V <sub>SSA</sub>		Analog ground	
16	V <sub>SSYC</sub>		Ground for YC output buffers	
27	V <sub>SSRGB</sub>		Ground for RGB output buffers	



# Package Dimensions

## SSOP-28

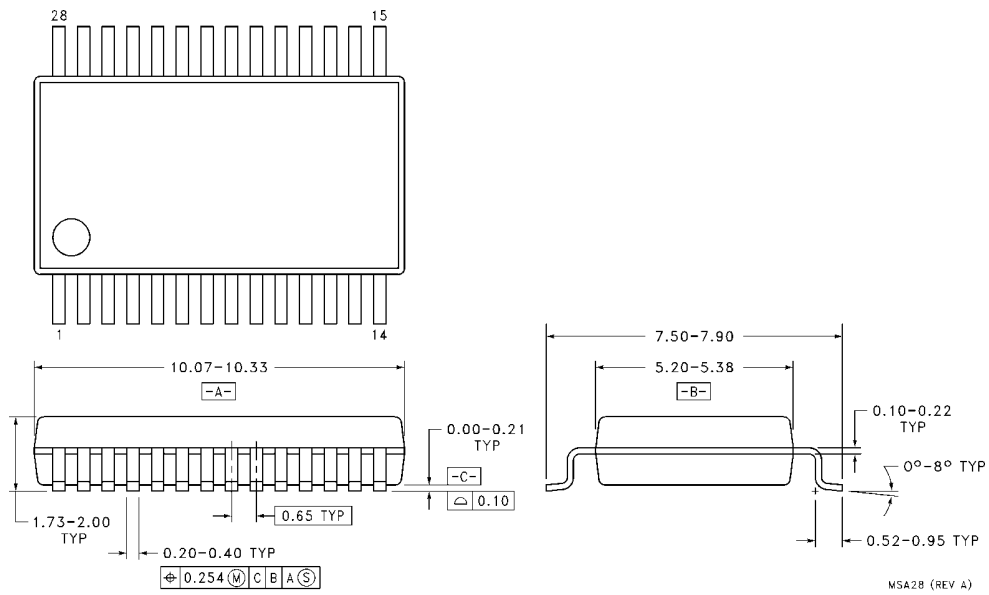

## Ordering Information

Model	Part Number	Package	Container	Pack Qty
FMS6419	FMS6419MSA28	28-pin SSOP	Tube	47
FMS6419	FMS6419MSA28X	28-pin SSOP	Tape & Reel	2,000

Temperature range for all parts: 0°C to +70°C.

---

**DISCLAIMER**

FAIRCHILD SEMICONDUCTOR RESERVES THE RIGHT TO MAKE CHANGES WITHOUT FURTHER NOTICES TO ANY PRODUCTS HEREIN TO IMPROVE RELIABILITY, FUNCTION OR DESIGN. FAIRCHILD DOES NOT ASSUME ANY LIABILITY ARISING OUT OF THE APPLICATION OR USE OF ANY PRODUCT OR CIRCUIT DESCRIBED HEREIN; NEITHER DOES IT CONVEY ANY LICENSE UNDER ITS PATENT RIGHTS, NOR THE RIGHTS OF OTHERS.

**LIFE SUPPORT POLICY**

FAIRCHILD'S PRODUCTS ARE NOT AUTHORIZED FOR USE AS CRITICAL COMPONENTS IN LIFE SUPPORT DEVICES OR SYSTEMS WITHOUT THE EXPRESS WRITTEN APPROVAL OF THE PRESIDENT OF FAIRCHILD SEMICONDUCTOR CORPORATION. As used herein:

1. Life support devices or systems are devices or systems which, (a) are intended for surgical implant into the body, or (b) support or sustain life, and (c) whose failure to perform when properly used in accordance with instructions for use provided in the labeling, can be reasonably expected to result in a significant injury of the user.
2. A critical component in any component of a life support device or system whose failure to perform can be reasonably expected to cause the failure of the life support device or system, or to affect its safety or effectiveness.