

FEATURES

- Lower $R_{DS(on)}$
- Improved inductive ruggedness
- Fast switching times
- Rugged polysilicon gate cell structure
- Lower input capacitance
- Extended safe operating area
- Improved high temperature reliability

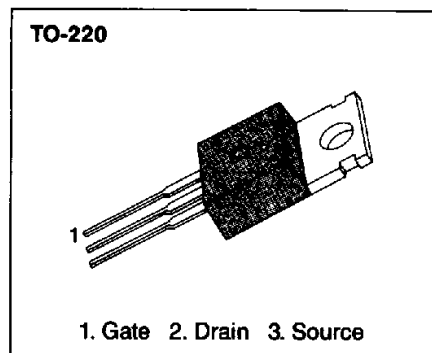

PRODUCT SUMMARY

Part Number	BV_{DSS}	$R_{DS(on)}$	I_D
SSP5N80	800V	2.5Ω	5.0A
SSP5N70	700V	2.5Ω	5.0A

ABSOLUTE MAXIMUM RATINGS

Characteristic	Symbol	SSP5N80	SSP5N70	Unit
Drain-Source Voltage (1)	V_{DSS}	800	700	Vdc
Drain-Gate Voltage ($R_{GS}=1.0M\Omega$)	V_{DGR}	800	700	Vdc
Gate-Source Voltage	V_{GS}	± 30		Vdc
Continuous Drain Current $T_C=25^\circ C$	I_D	5.0		Adc
Continuous Drain Current $T_C=100^\circ C$	I_D	3.5		Adc
Drain Current - Pulsed (3)	I_{DM}	20		Adc
Single Pulsed Avalanche Energy (4)	EAS	280		mJ
Avalanche Current	I_{AS}	5.0		A
Total Power Dissipation at $T_C=25^\circ C$	P_D	140		Watts
Derate above $25^\circ C$		1.11		W/ $^\circ C$
Operating and Storage Junction Temperature Range	T_J, T_{STG}	-55 to +150		$^\circ C$
Maximum Lead Temp. for Soldering Purposes, 1/8" from case for 5 seconds	T_L	300		$^\circ C$

Notes : (1) $T_J=25^\circ C$ to $150^\circ C$

(2) Pulse test : Pulse width $\leq 300\mu s$, Duty Cycle $\leq 2\%$

(3) Repetitive rating : Pulse width limited by max. junction temperature

(4) $L=33mH$, $V_{dd}=50V$, $R_G=25\Omega$, Starting $T_J=25^\circ C$

ELECTRICAL CHARACTERISTICS (Tc=25°C unless otherwise specified)

Symbol	Characteristic	Min	Typ	Max	Units	Test Conditions
BV _{DSS}	Drain-Source Breakdown Voltage					
	SSP5N80	800	-	-	V	V _{GS} =0V, I _D =250μA
	SSP5N70	700	-	-	V	
V _{GS(th)}	Gate Threshold Voltage	2.0	-	4.5	V	V _{DS} =V _{GS} , I _D =250μA
I _{GSS}	Gate-Source Leakage Forward	-	-	100	nA	V _{GS} =20V
I _{GSS}	Gate-Source Leakage Reverse	-	-	-100	nA	V _{GS} =-20V
I _{DSS}	Zero Gate Voltage Drain Current	-	-	250	μA	V _{DS} =Max. Rating, V _{GS} =0V
		-	-	1000	μA	V _{DS} =0.8 Max. Rating, V _{GS} =0V, Tc=125°C
R _{DS(on)}	Static Drain-Source On-Resistance(2)	-	-	2.5	Ω	V _{GS} =10V, I _D =2.5A
g _{fs}	Forward Transconductance (2)	2.5	3.6	-	U	V _{DS} ≥50V, I _D =2.5A
C _{iss}	Input Capacitance	-	1457	-	pF	V _{GS} =0V, V _{DS} =25V, f=1.0MHz
C _{oss}	Output Capacitance	-	130	-	pF	
C _{rss}	Reverse Transfer Capacitance	-	38.8	-	pF	
t _{d(on)}	Turn-On Delay Time	-	-	60	ns	V _{DD} =0.5 BV _{DSS} , I _D =5.0A, Z _o =9.1Ω (MOSFET switching times are essentially independent of operating temperature)
t _r	Rise Time	-	-	150	ns	
t _{d(off)}	Turn-Off Delay Time	-	-	300	ns	
t _f	Fall Time	-	-	130	ns	
Q _g	Total Gate Charge (Gate-Source Plus Gate-Drain)	-	-	56	nC	V _{GS} =10V, I _D =5.0A, V _{DS} =0.8 Max. Rating (Gate charge is essentially independent of operating temperature)
Q _{gs}	Gate-Source Charge	-	10.3	-	nC	
Q _{gd}	Gate-Drain ("Miller") Charge	-	22.3	-	nC	

THERMAL RESISTANCE

Symbol	Characteristics		All	Units	Remark
R _{thJC}	Junction-to-Case	MAX	0.90	K/W	
R _{thCS}	Case-to-Sink	TYP	0.5	K/W	Mounting surface flat, Smooth and greased
R _{thJA}	Junction-to-Ambient	MAX	62.5	K/W	Free Air Operation

- Notes : (1) T_J=25°C to 150°C
 (2) Pulse test : Pulse width ≤ 300μs, Duty Cycle ≤ 2%
 (3) Repetitive rating : Pulse width limited by max. junction temperature

SOURCE-DRAIN DIODE RATINGS AND CHARACTERISTICS

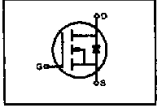
Symbol	Characteristic	Min	Typ	Max	Units	Test Conditions
I_S	Continuous Source Current (Body Diode)	-	-	5.0	A	Modified MOSFET symbol showing the integral reverse P-N junction rectifier 
I_{SM}	Pulse Source Current (Body Diode) (3)	-	-	20	A	
V_{SD}	Diode Forward Voltage (2)	-	-	1.5	V	$T_J=25^\circ\text{C}$, $I_S=5.0\text{A}$, $V_{GS}=0\text{V}$
t_{rr}	Reverse Recovery Time	-	600	-	ns	$T_J=25^\circ\text{C}$, $I_F=5.0\text{A}$, $dI_F/dt=100\text{A}/\mu\text{S}$

Notes : (1) $T_J=25^\circ\text{C}$ to 150°C

(2) Pulse test : Pulse width $\leq 300\mu\text{s}$, Duty Cycle $\leq 2\%$

(3) Repetitive rating : Pulse width limited by max. junction temperature

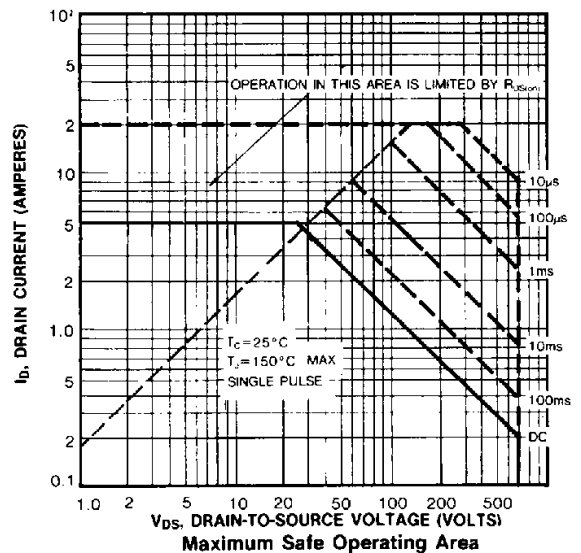
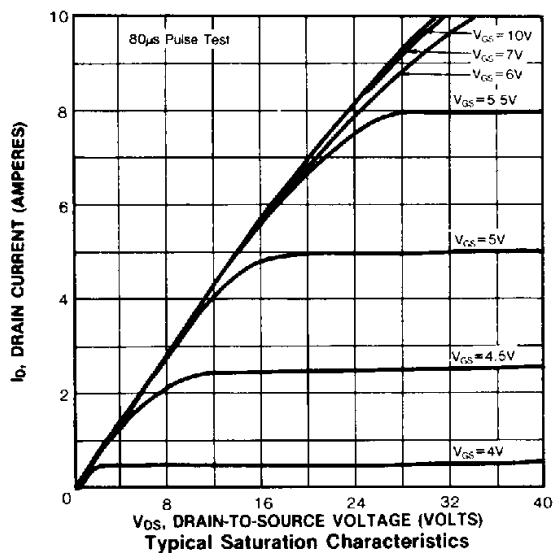
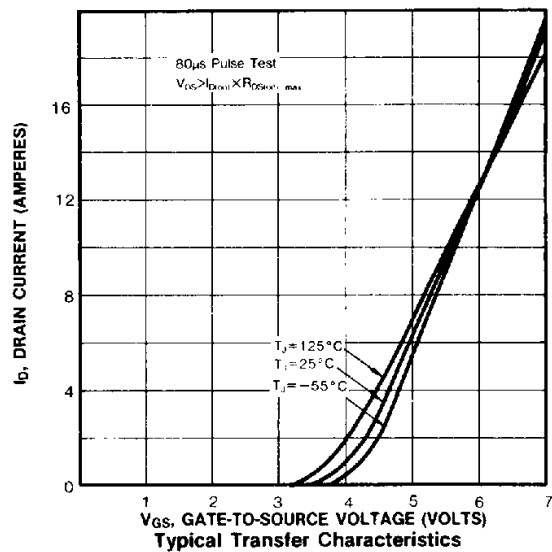
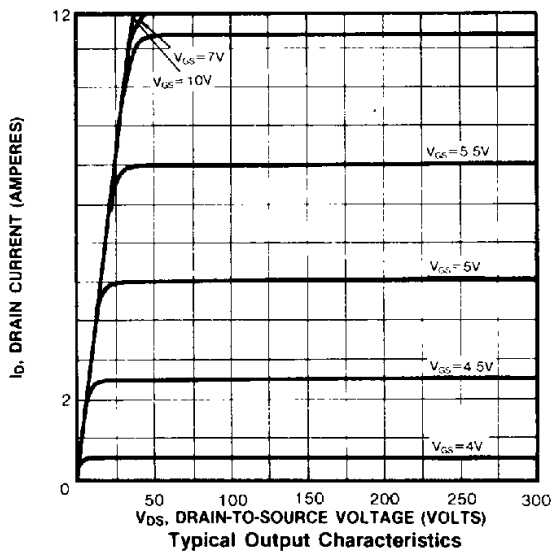

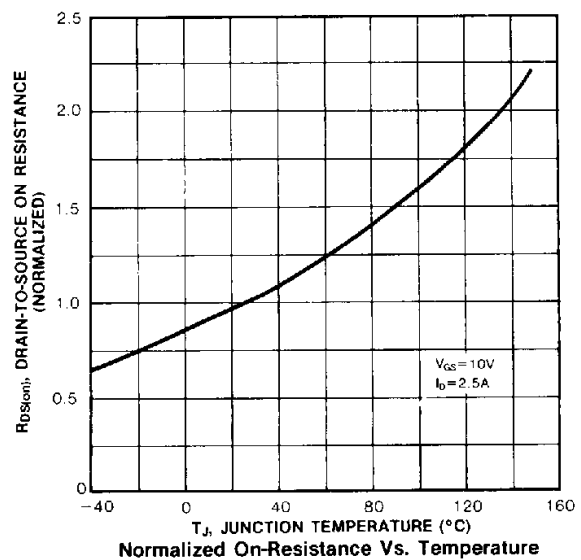
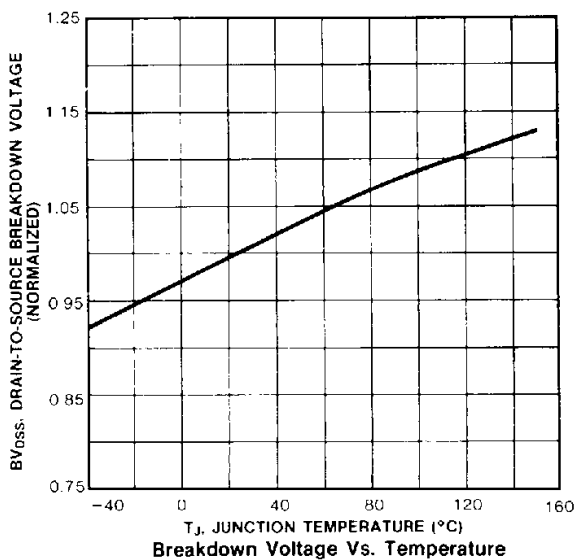
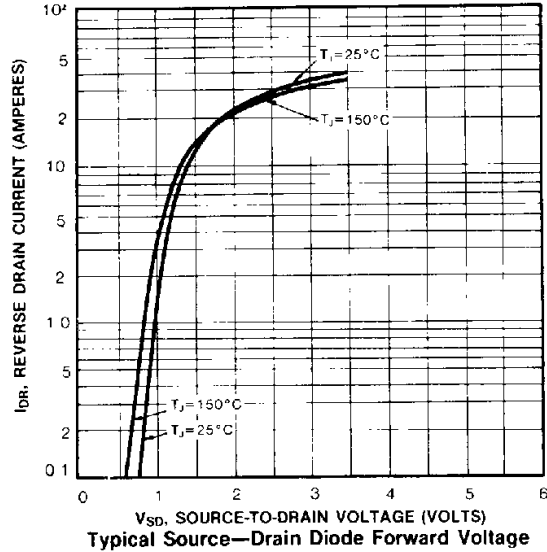
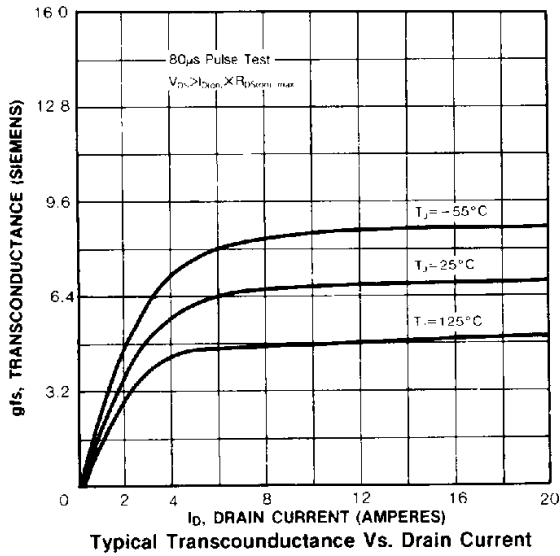
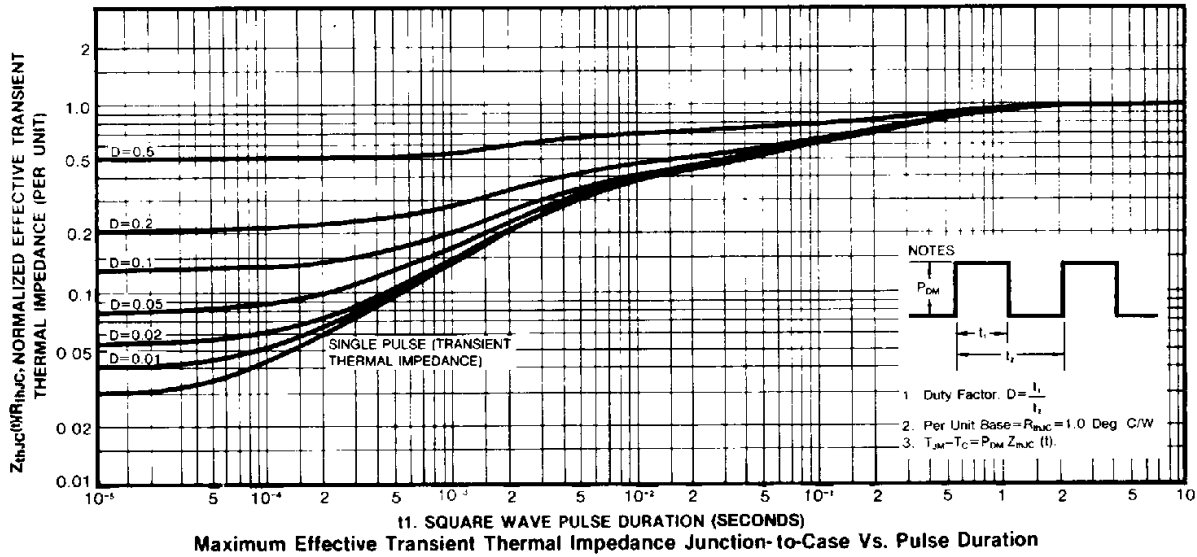

4

