

■ Features

- Colorless transparency lens type
- $\Phi 5\text{mm}(T-1\frac{3}{4})$ all plastic mold type
- High Luminosity

■ Outline dimensions

(unit : mm)

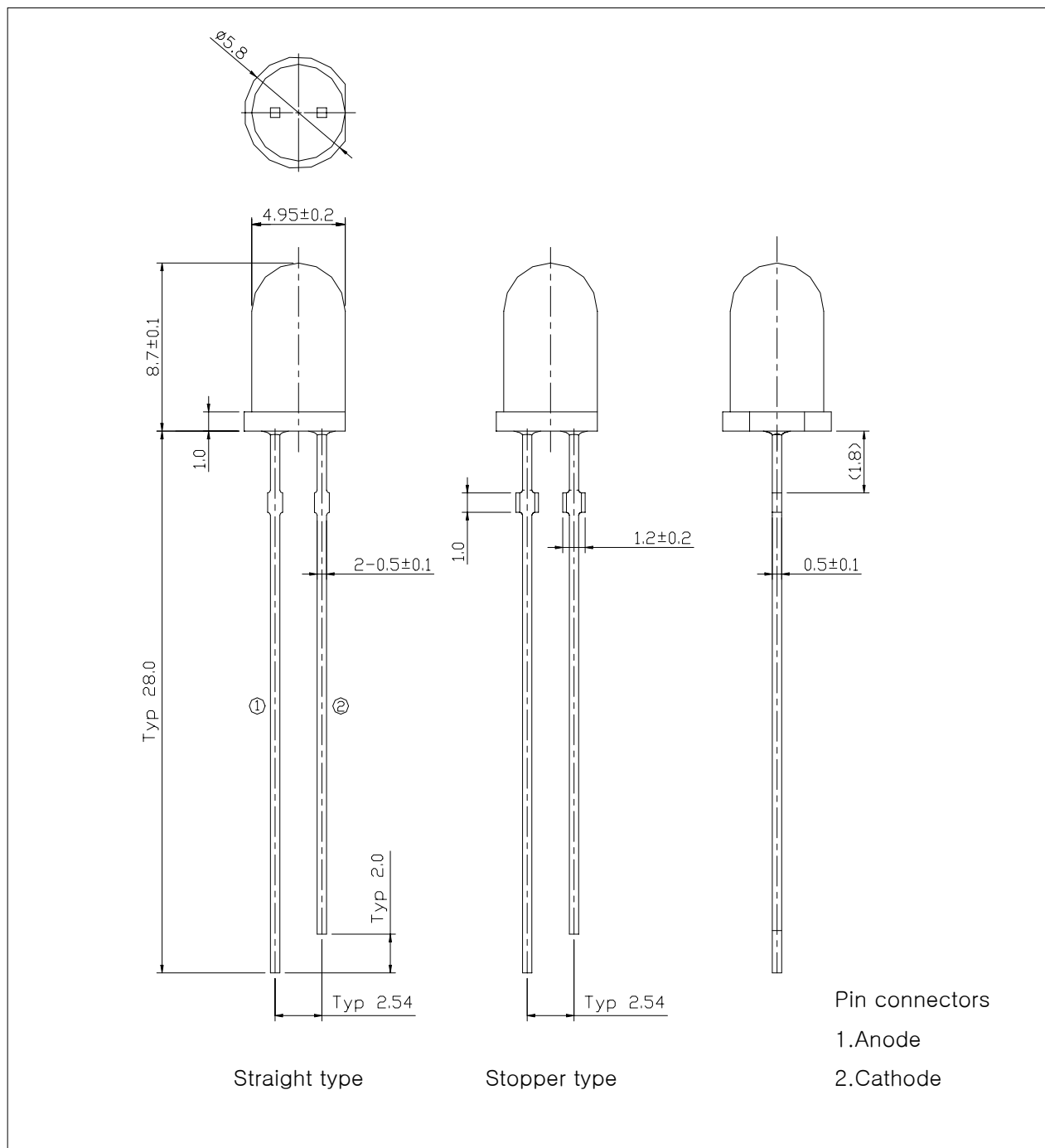

Pin connectors
1. Anode
2. Cathode

Different and Better

■ Absolute Maximum Ratings

Characteristic	Symbol	Ratings	Unit
Power Dissipation	P_D	75	mW
Forward Current	I_F	30	mA
* ¹ Peak Forward Current	I_{FP}	100	mA
Reverse Voltage	V_R	5	V
Operating Temperature	T_{opr}	-30 ~ +85	°C
Storage Temperature	T_{stg}	-40 ~ +100	°C
* ² Soldering Temperature	T_{sol}	260°C for 3 seconds	

*1. Duty ratio 1/10, Pulse Width 10msec

*2. Keep the distance more than 2.0mm from PCB to the bottom of LED package

■ Electrical – Optical Characteristics

($T_a=25^\circ\text{C}$)

Characteristic	Symbol	Test Condition	Min.	Typ.	Max.	Unit
Forward Voltage	V_F	$I_F=20\text{mA}$	-	2.1	2.5	V
Dominant Wavelength	λ_D	$I_F=20\text{mA}$	-	621	-	nm
Spectrum Bandwidth	$\Delta\lambda$	$I_F=20\text{mA}$	-	25	-	nm
Reverse Current	I_R	$V_R=5\text{V}$	-	-	10	uA
* ³ Half Angle	$\theta_{1/2}$	$I_F=20\text{mA}$	-	± 20	-	deg

*3. $\theta_{1/2}$ is the off-axis angle where the luminous intensity is 1/2 the peak intensity

■ Luminous intensity ranks

(Ta=25°C)

Iv RANK	Test Condition	Min.	Typ.	Max.	Unit
P	I _F = 20mA	1200	–	1700	mcd
Q		1700	–	2400	
R		2400	–	3400	
S		3400	–	4800	

* Luminous intensity is tested at a current pulse duration of 25 ms and an accuracy of ±11%.

Intensity Measured : 0.01sr(CIE. LED_B)

■ Precautions On LED using

* To avoid optical difference, Please do not mix differently-ranked product.

■ Characteristic Diagrams

Fig. 1 I_F - V_F

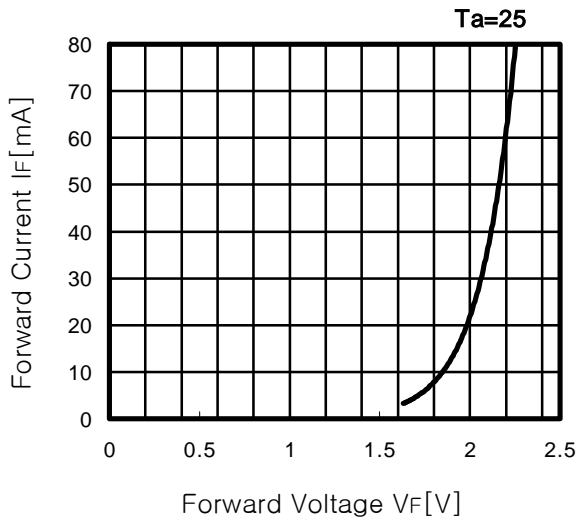

Fig. 2 I_v - I_F

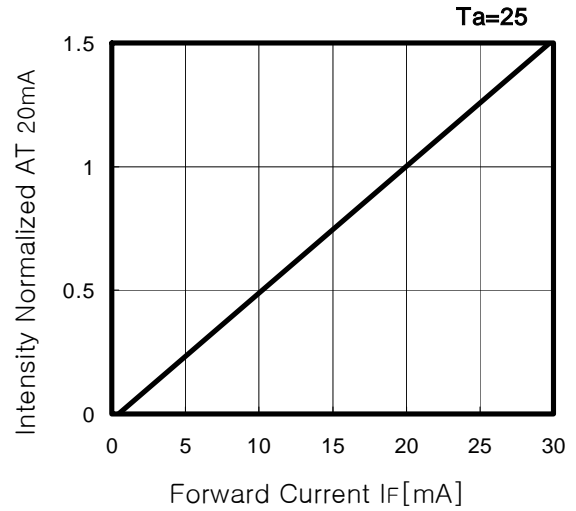

Fig. 3 Max. Permissible Forward Current

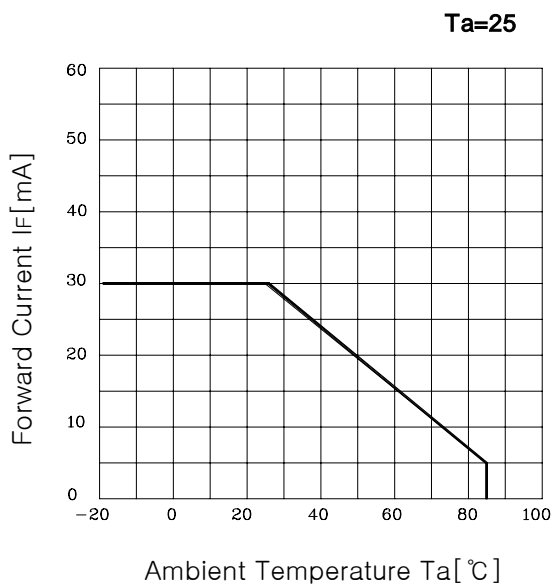

Fig. 4 Spectrum Distribution

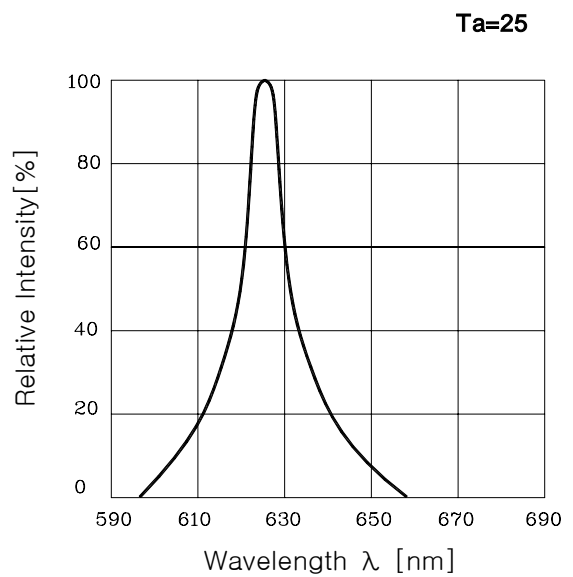

Fig. 5 Relative Intensity - Ta

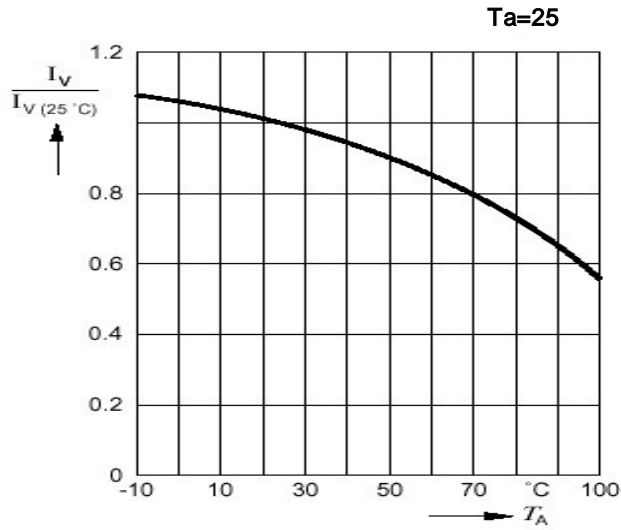
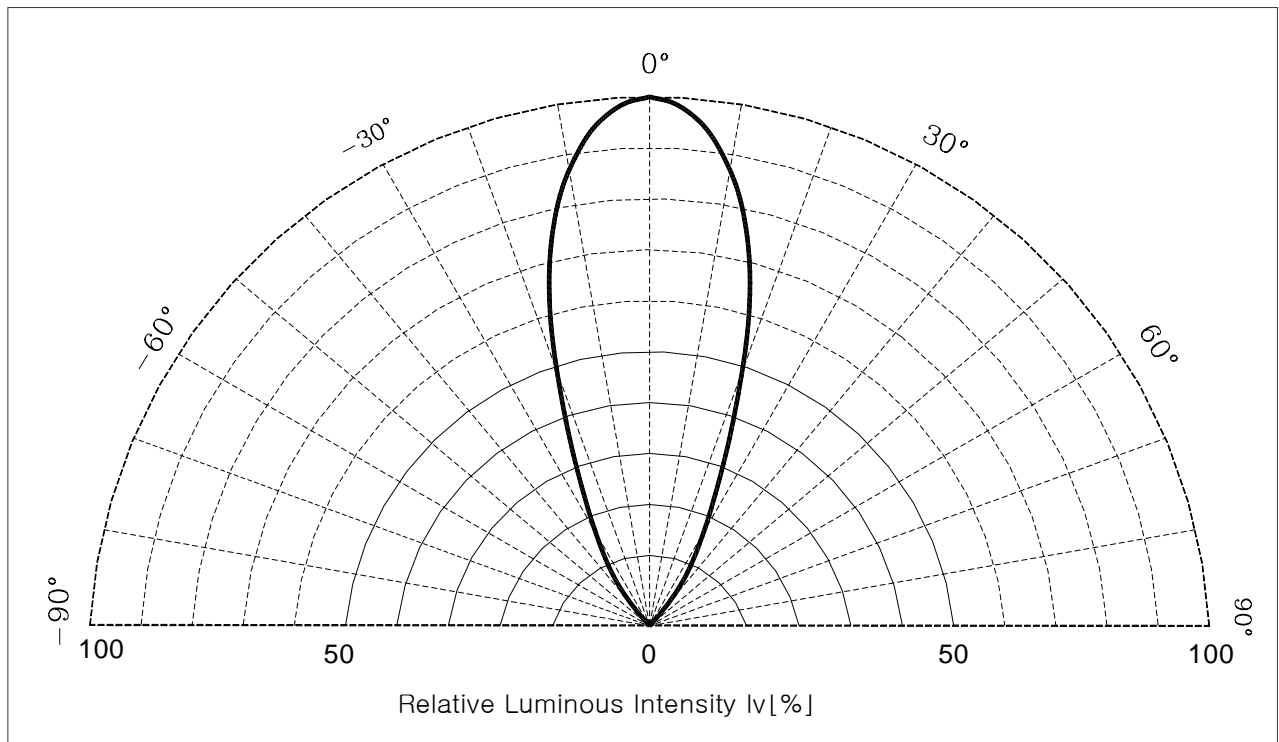

Fig. 6 Radiation Diagram



■ Revision history sheet

Spec NO.			
Title	Specification for Approval		
Times	Date	Summary of revision	Remarks
1	2001. 07. 15	신규제정	
2	2003. 02. 26	Format 변경	
3	2004. 06. 03	Iv Rank 변경	

Different and Better



LOU5020
Ultra Brightness LED Lamp
