

PRELIMINARY DATA SHEET

SKY12146-321: GaAs IC 25 dB Voltage Variable Attenuator 2.7–4.0 GHz

Features

- Power control for 3.5 GHz fixed wireless applications
- Minimum 25 dB attenuation
- Positive 0.2–1.2 V control voltage
- QFN-12 3 x 3 mm package
- Low cost
- No external components needed

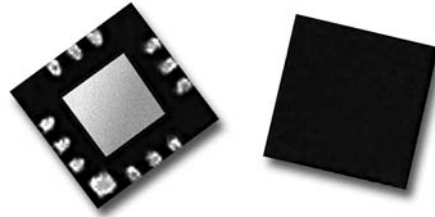

Description

The SKY12146-321 is a GaAs IC PHEMT voltage variable attenuator that has been designed for WLAN applications. Operating from 2.7–4.0 GHz, the SKY12146-321 is ideal for low cost applications such as 3.5 GHz fixed wireless LAN power control applications.

Absolute Maximum Ratings

Characteristic	Value
RF input power	1 W max.
Control voltage	-0.2 V, +6 V
Operating temperature	-40 °C to +85 °C
Storage temperature	-65 °C to +150 °C

1. All measurements made in a 50 Ω system, unless otherwise specified.
2. For worst case state.

Electrical Specifications at 25 °C

Parameter	Frequency	Min.	Typ.	Max.	Unit
Insertion loss ($V_C = 1.2$ V)	2.7–4.0 GHz		1.5	1.8	dB
Maximum attenuation ($V_C = 0.2$ V)	2.7–4.0 GHz	22	25		dB
VSWR — all ports	2.7–4.0 GHz		1.5	1.8	

Operating Characteristics at 25 °C (0, +1.2 V)

Parameter	Condition	Frequency	Min.	Typ.	Max.	Unit
Switching characteristics	Rise, fall (10/90% or 90/10% RF)		80	50		ns
	On, off (50% CTL to 90/10% RF)			150		ns
	Video feedthru			25		mV
Maximum input power for < 1 dB attenuation variation		2.7–4.0 GHz		13		dBm
Input 3rd order intercept point (IIP3)		2.7–4.0 GHz		20		dBm
Control voltage			0.2		1.2	V

1. All measurements made in a 50 Ω system, unless otherwise specified.
2. For worst case state.

Typical Performance Data at 25 °C

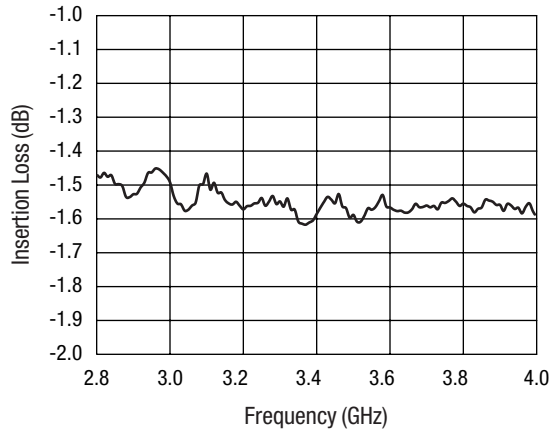

Insertion Loss vs. Frequency

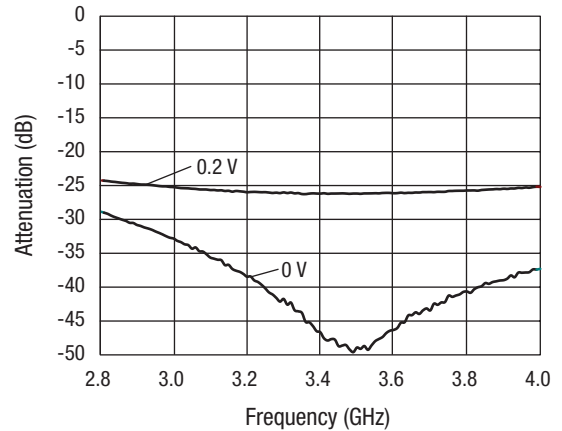

Maximum Attenuation vs. Frequency

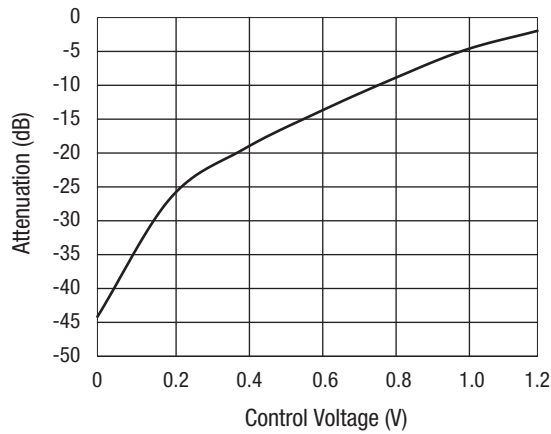

Attenuation vs. Control Voltage

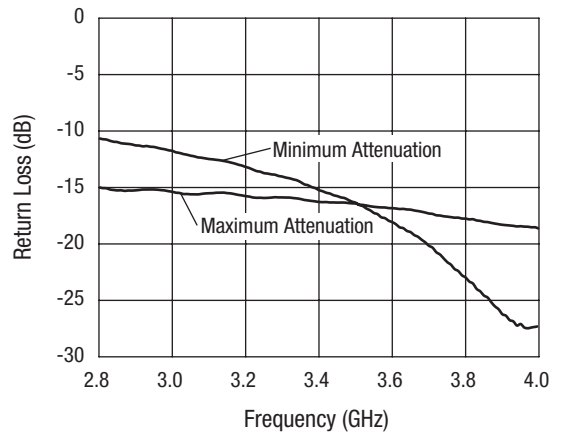

Input Return Loss vs. Frequency

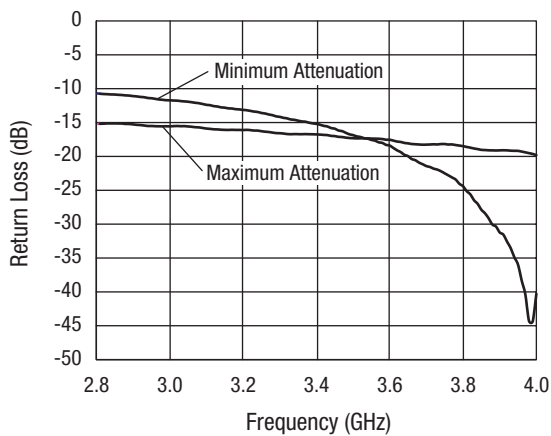

Output Return Loss vs. Frequency

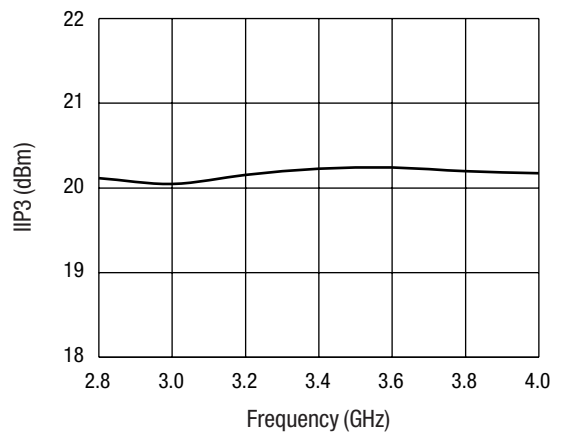

Input IP3 vs. Frequency

Pin Out

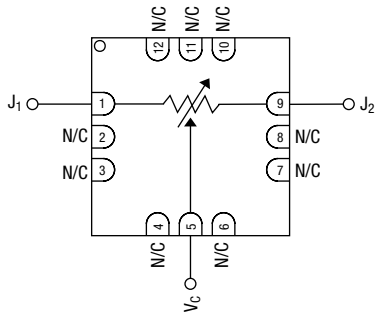

Ground is connected to paddle on bottom.

QFN-12

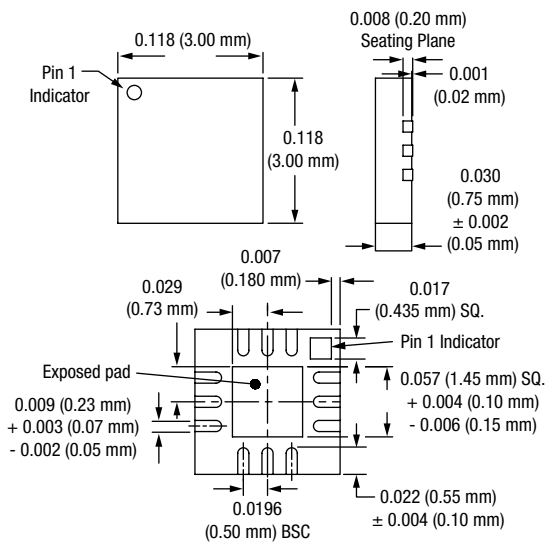

Evaluation Board Layout

