



## P-Channel Enhancement Mode MOSFET

PRODUCT SUMMARY		
V <sub>DSS</sub>	I <sub>D</sub>	R <sub>DS(ON)</sub> (mΩ) Max
-20V	-8A	20 @ V <sub>GS</sub> = -4.5V
		28 @ V <sub>GS</sub> = -2.5V

### FEATURES

- Super high dense cell design for low R<sub>DS(ON)</sub>.
- Rugged and reliable.
- Surface Mount Package.

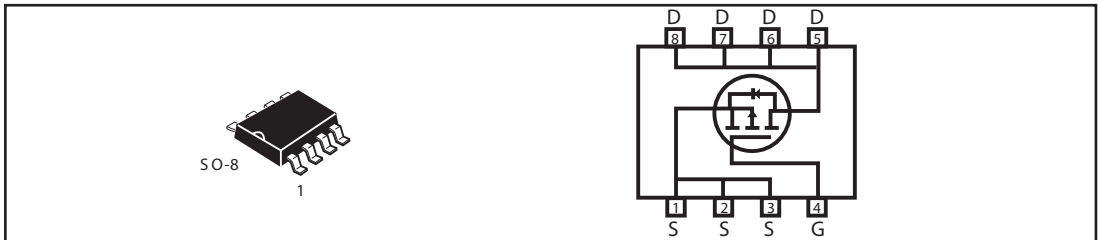

### ABSOLUTE MAXIMUM RATINGS (T<sub>A</sub>=25°C unless otherwise noted)

Parameter	Symbol	Limit	Unit
Drain-Source Voltage	V <sub>DS</sub>	- 20	V
Gate-Source Voltage	V <sub>GS</sub>	± 10	V
Drain Current-Continuous <sup>a</sup> @ T <sub>J</sub> =25°C -Pulsed <sup>b</sup>	I <sub>D</sub>	- 8	A
	I <sub>DM</sub>	- 32	A
Drain-Source Diode Forward Current <sup>a</sup>	I <sub>S</sub>	-1.7	A
Maximum Power Dissipation <sup>a</sup>	P <sub>D</sub>	2.5	W
Operating Junction and Storage Temperature Range	T <sub>J</sub> , T <sub>STG</sub>	-55 to 150	°C

### THERMAL CHARACTERISTICS

Thermal Resistance, Junction-to-Ambient <sup>a</sup>	R <sub>θJA</sub>	50	°C/W
--	------------------	----	------

# STM6375

ELECTRICAL CHARACTERISTICS (TA=25°C unless otherwise noted)

Parameter	Symbol	Condition	Min	Typ <sup>c</sup>	Max	Unit
<b>OFF CHARACTERISTICS</b>						
Drain-Source Breakdown Voltage	BV <sub>DSS</sub>	V <sub>GS</sub> =0V, I <sub>D</sub> =-250uA	-20			V
Zero Gate Voltage Drain Current	I <sub>DSS</sub>	V <sub>DS</sub> =-16V, V <sub>GS</sub> =0V			-1	uA
Gate-Body Leakage	I <sub>GSS</sub>	V <sub>GS</sub> =±10V, V <sub>DS</sub> =0V			±100	nA
<b>ON CHARACTERISTICS<sup>b</sup></b>						
Gate Threshold Voltage	V <sub>GS(th)</sub>	V <sub>DS</sub> =V <sub>GS</sub> , I <sub>D</sub> =-250uA	-0.6	-0.8	-1.5	V
Drain-Source On-State Resistance	R <sub>DS(ON)</sub>	V <sub>GS</sub> =-4.5V, I <sub>D</sub> =-8A		14	20	m-ohm
		V <sub>GS</sub> =-2.5V, I <sub>D</sub> =-6A		19	28	m-ohm
On-State Drain Current	I <sub>D(ON)</sub>	V <sub>DS</sub> =-5V, V <sub>GS</sub> =-4.5V	-20			A
Forward Transconductance	g <sub>FS</sub>	V <sub>DS</sub> =-5V, I <sub>D</sub> =-5A		20		S
<b>DYNAMIC CHARACTERISTICS<sup>c</sup></b>						
Input Capacitance	C <sub>ISS</sub>	V <sub>DS</sub> =-10V, V <sub>GS</sub> =0V f=1.0MHz		1932		pF
Output Capacitance	C <sub>OSS</sub>			550		pF
Reverse Transfer Capacitance	C <sub>RSS</sub>			115		pF
<b>SWITCHING CHARACTERISTICS<sup>c</sup></b>						
Turn-On Delay Time	t <sub>D(ON)</sub>	V <sub>D</sub> =-10V, R <sub>L</sub> =10 ohm I <sub>D</sub> =-1A, V <sub>GEN</sub> =-4.5V, R <sub>GEN</sub> =6 ohm		51.8		ns
Rise Time	t <sub>r</sub>			23.7		ns
Turn-Off Delay Time	t <sub>D(OFF)</sub>			335		ns
Fall Time	t <sub>f</sub>			133		ns
Total Gate Charge	Q <sub>g</sub>	V <sub>DS</sub> =-10V, I <sub>D</sub> =-8A, V <sub>GS</sub> =-10V		30		nC
		V <sub>DS</sub> =-1V, I <sub>D</sub> =-8A, V <sub>GS</sub> =-4.5V		7		nC
Gate-Source Charge	Q <sub>gs</sub>	V <sub>DS</sub> =-10V, I <sub>D</sub> =-8A, V <sub>GS</sub> =-10V		6.5		nC
Gate-Drain Charge	Q <sub>gd</sub>			5.8		nC

# STM6375

## ELECTRICAL CHARACTERISTICS ( $T_A=25^\circ\text{C}$ unless otherwise noted)

Parameter	Symbol	Condition	Min	Typ <sup>c</sup>	Max	Unit
<b>DRAIN-SOURCE DIODE CHARACTERISTICS<sup>b</sup></b>						
Diode Forward Voltage	$V_{SD}$	$V_{GS} = 0V, I_s = -1.7A$		-0.75	-1.2	V

### Notes

- a. Surface Mounted on FR4 Board,  $t_r \leq 10\text{sec}$ .
- b. Pulse Test: Pulse Width  $\leq 300\mu\text{s}$ , Duty Cycle  $\leq 2\%$ .
- c. Guaranteed by design, not subject to production testing.

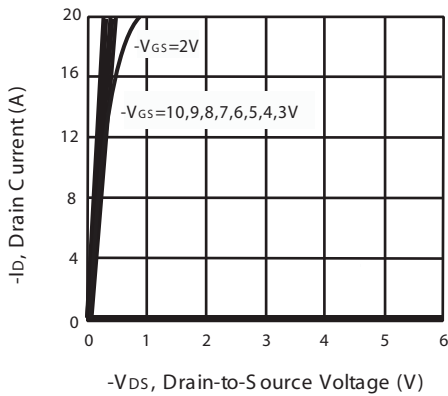

Figure 1. Output Characteristics

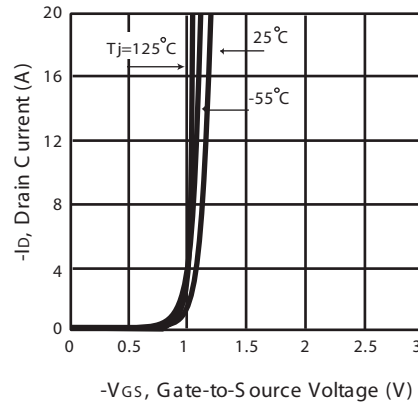

Figure 2. Transfer Characteristics

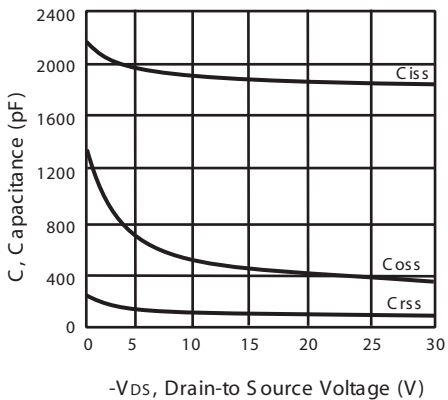

Figure 3. Capacitance

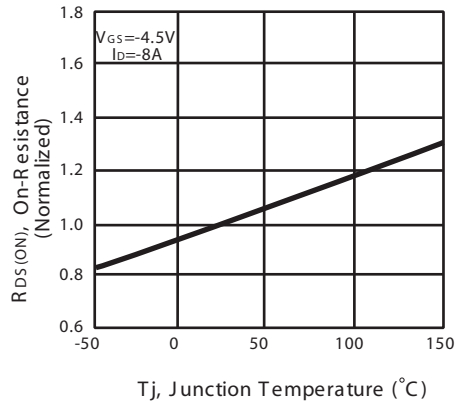

Figure 4. On-Resistance Variation with Temperature

# STM6375

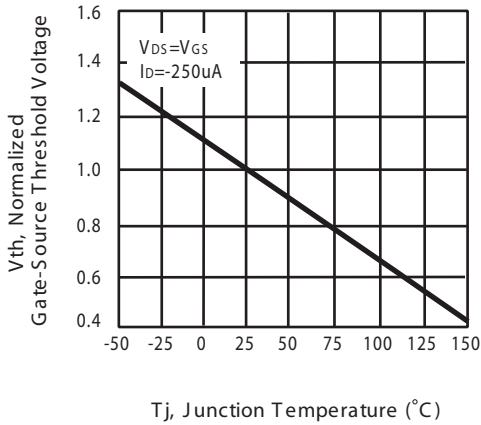

Figure 5. Gate Threshold Variation with Temperature

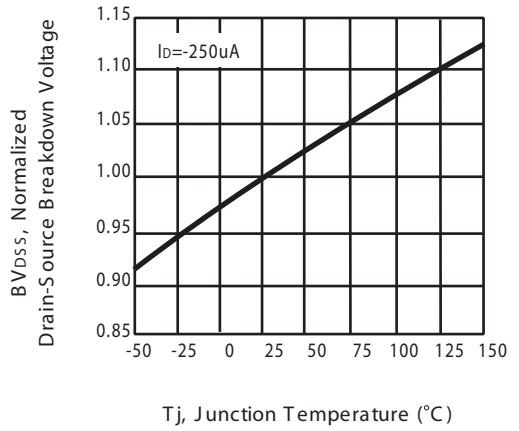

Figure 6. Breakdown Voltage Variation with Temperature

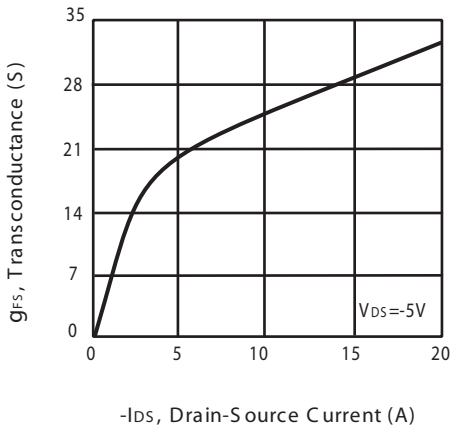

Figure 7. Transconductance Variation with Drain Current

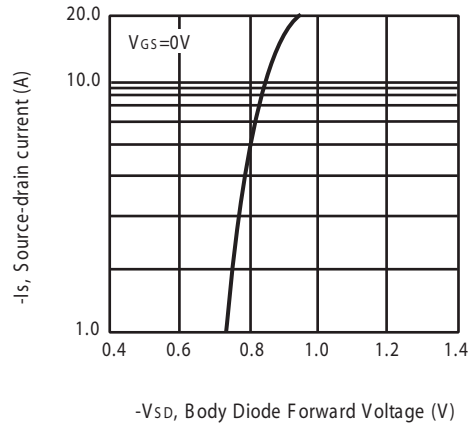

Figure 8. Body Diode Forward Voltage Variation with Source Current

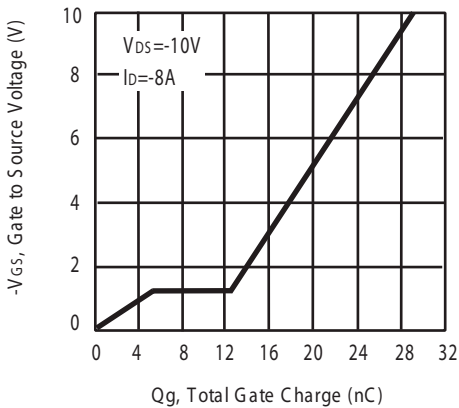

Figure 9. Gate Charge

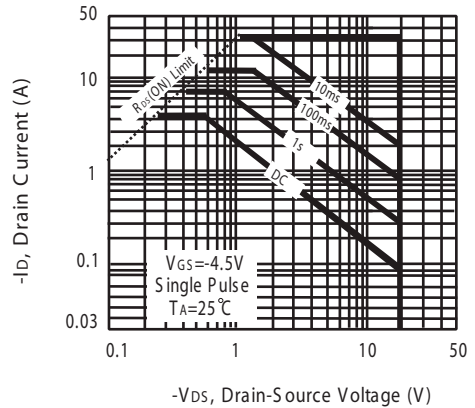

Figure 10. Maximum Safe Operating Area

# STM6375

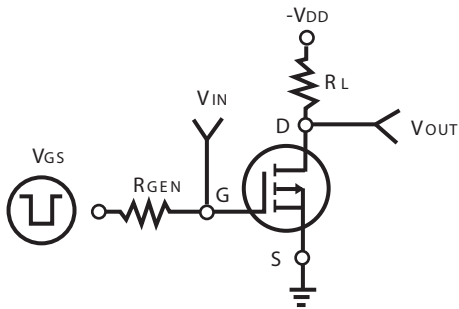

Figure 11. Switching Test Circuit

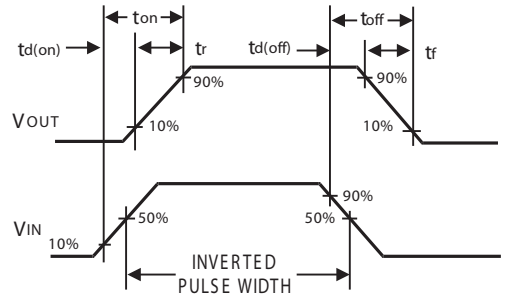

Figure 12. Switching Waveforms

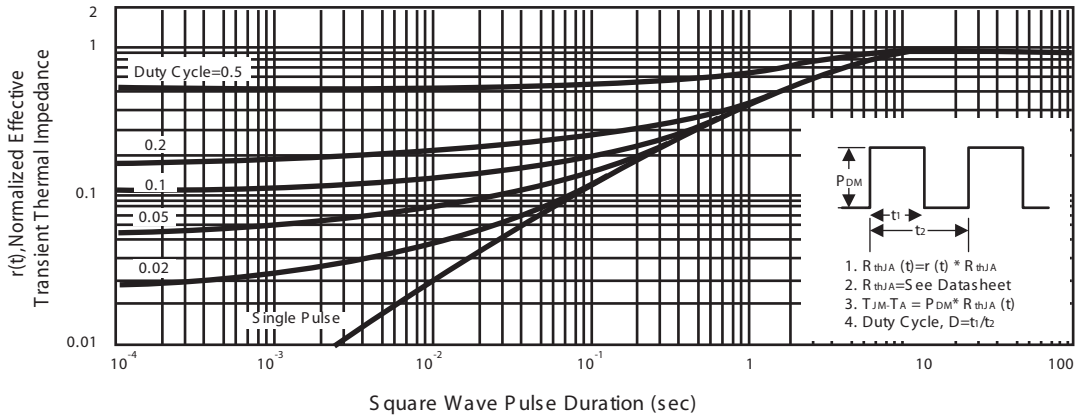

Figure 13. Normalized Thermal Transient Impedance Curve



# STM6375

## SO-8 Tape and Reel Data

### SO-8 Carrier Tape

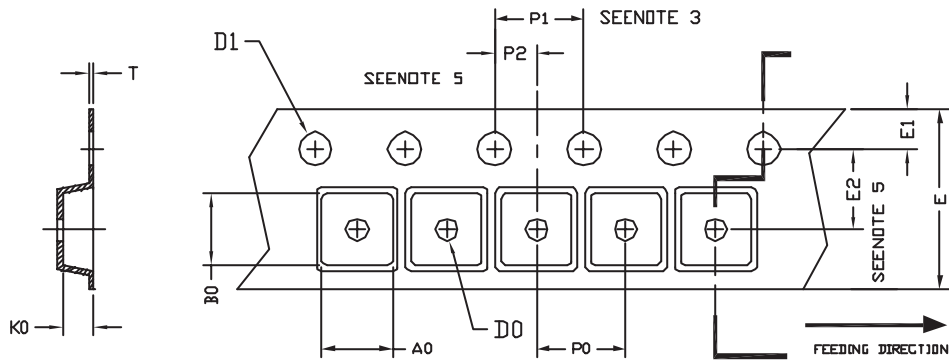

unit:mm

PACKAGE	A0	B0	K0	D0	D1	E	E1	E2	P0	P1	P2	T
SOP 8N 150mil	6.40	5.20	2.10	$\phi$ 1.5 (MIN)	$\phi$ 1.5 + 0.1 - 0.0	12.0 $\pm$ 0.3	1.75	5.5 $\pm$ 0.05	8.0	4.0	2.0 $\pm$ 0.05	0.3 $\pm$ 0.05

### SO-8 Reel

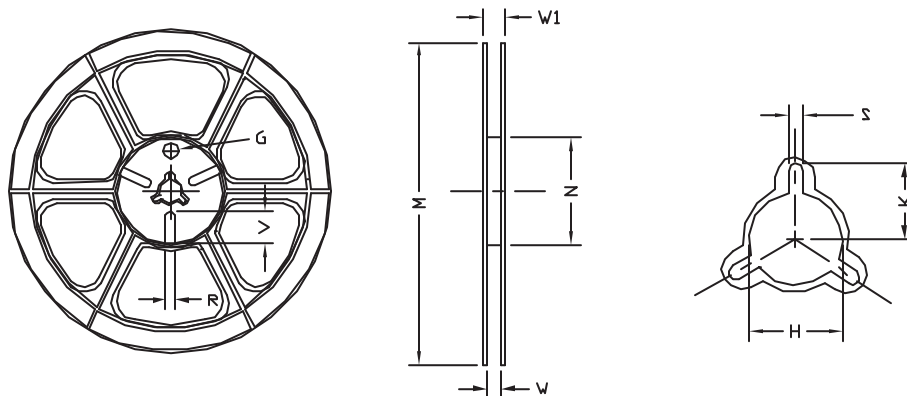

UNIT:mm

TAPE SIZE	REEL SIZE	M	N	W	W1	H	K	S	G	R	V
12 mm	$\phi$ 330	330 $\pm$ 1	62 $\pm$ 1.5	12.4 + 0.2	16.8 - 0.4	$\phi$ 12.75 + 0.15	---	2.0 $\pm$ 0.15	---	---	---