

POWER AMPLIFIER APPLICATION.
POWER SWITCHING APPLICATION.

FEATURES

- Low Collector Saturation Voltage
: $V_{CE(sat)}=0.5V(\text{Max.}) (I_C=1A)$
- High Speed Switching Time : $t_{stg}=1\mu S(\text{Typ.})$
- Complementary to KTA1718D/L.

MAXIMUM RATING (Ta=25°C)

CHARACTERISTIC		SYMBOL	RATING	UNIT
Collector-Base Voltage		V_{CBO}	50	V
Collector-Emitter Voltage		V_{CEO}	50	V
Emitter-Base Voltage		V_{EBO}	5	V
Collector Current		I_C	2	A
Emitter Current		I_E	-2	A
Collector Power Dissipation	Ta=25°C	P_C	1.0	W
	Tc=25°C		10	
Junction Temperature		T_j	150	°C
Storage Temperature Range		T_{stg}	-55 ~ 150	°C

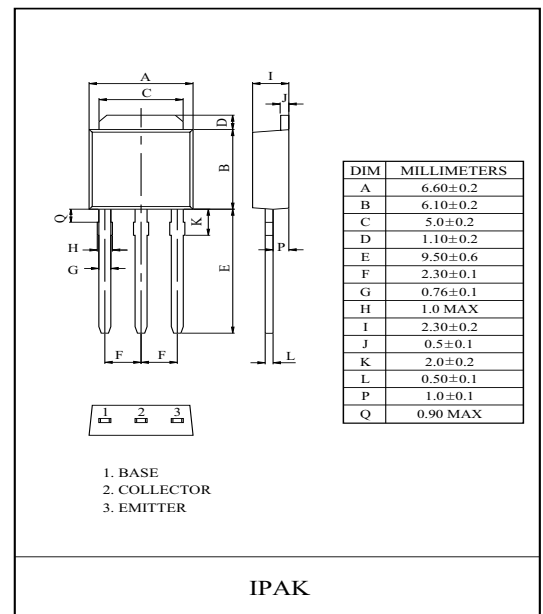
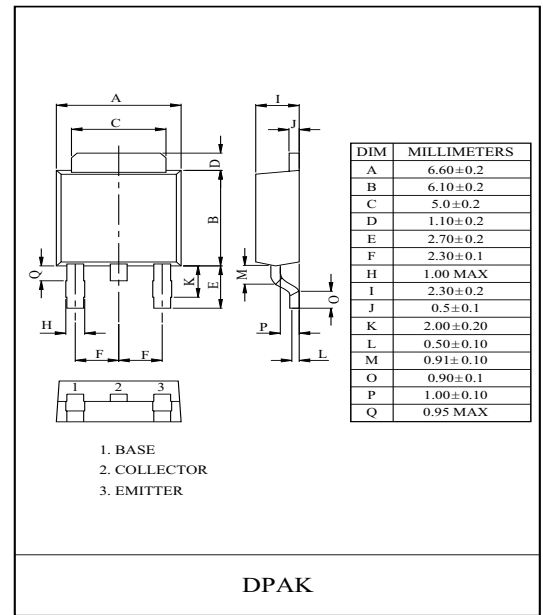

ELECTRICAL CHARACTERISTICS (Ta=25°C)

CHARACTERISTIC		SYMBOL	TEST CONDITION	MIN.	TYP.	MAX.	UNIT
Collector Cut-off Current		I_{CBO}	$V_{CB}=50V, I_E=0$	-	-	0.1	μA
Emitter Cut-off Current		I_{EBO}	$V_{EB}=5V, I_C=0$	-	-	0.1	μA
Collector-Emitter Breakdown Voltage		$V_{(BR)CEO}$	$I_C=10mA, I_B=0$	50	-	-	V
DC Current Gain	$h_{FE(1)}$ (Note)	$V_{CE}=2V, I_C=0.5A$	70	-	240		
	h_{FE2}	$V_{CE}=2V, I_C=1.5A$	40	-	-		
Collector-Emitter Saturation Voltage		$V_{CE(sat)}$	$I_C=1A, I_B=0.05A$	-	-	0.5	V
Base-Emitter Saturation Voltage		$V_{BE(sat)}$	$I_C=1A, I_B=0.05A$	-	-	1.2	V
Transition Frequency		f_T	$V_{CE}=2V, I_C=0.5A$	-	100	-	MHz
Collector Output Capacitance		C_{ob}	$V_{CB}=10V, I_E=0, f=1MHz$	-	30	-	pF
Switching Time	Turn On Time	t_{on}		-	0.1	-	μS
	Storage Time	t_{stg}		-	1.0	-	
	Fall Time	t_f		-	0.1	-	

Note : $h_{FE(1)}$ Classification O:70~140, Y:120~240.

KTC2815D/L

STATIC CHARACTERISTICS

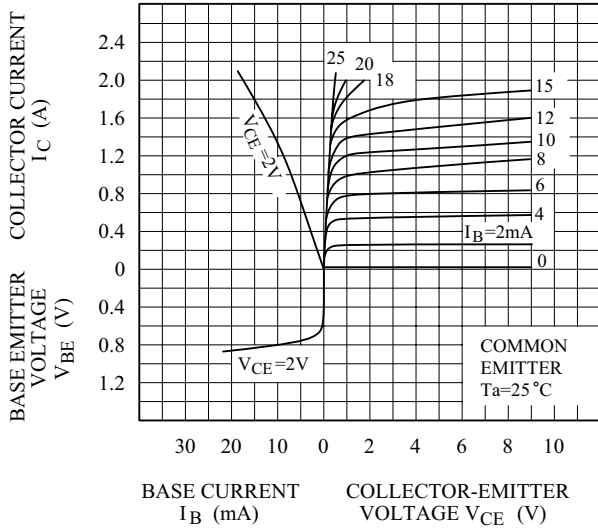

$V_{CE} - I_C$

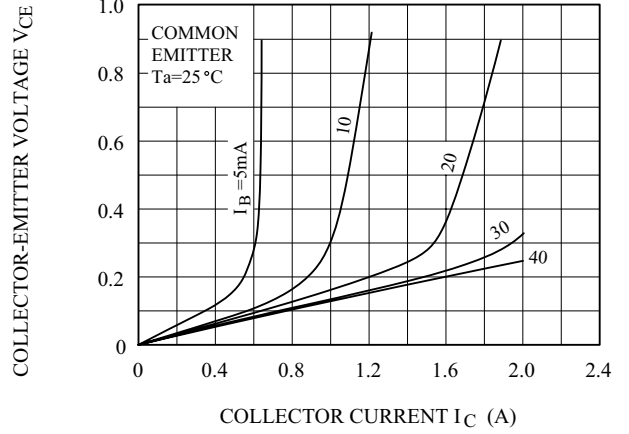

$V_{CE} - I_C$

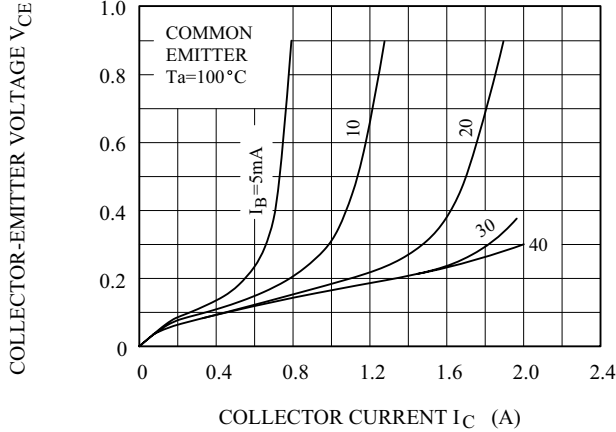

$V_{CE} - I_C$

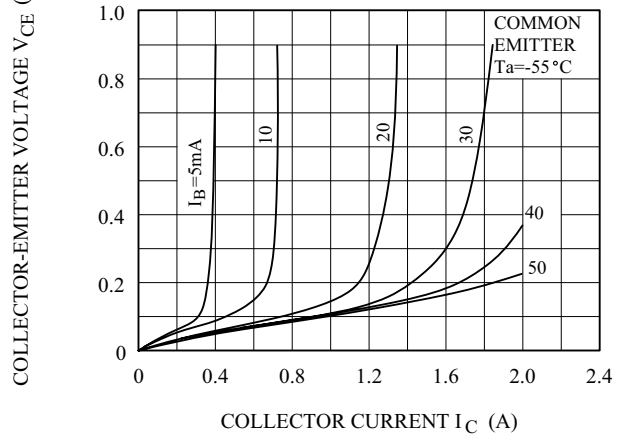

$h_{FE} - I_C$

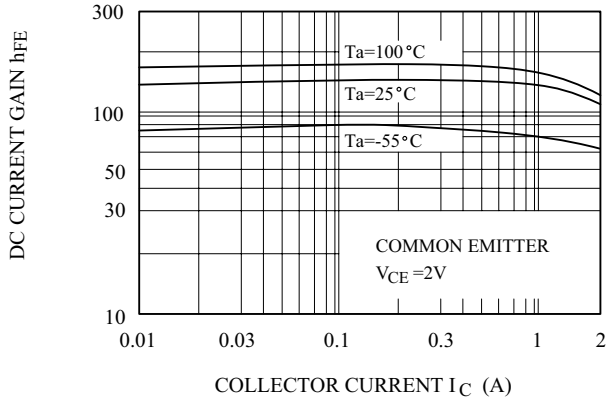

$V_{CE(sat)} - I_C$

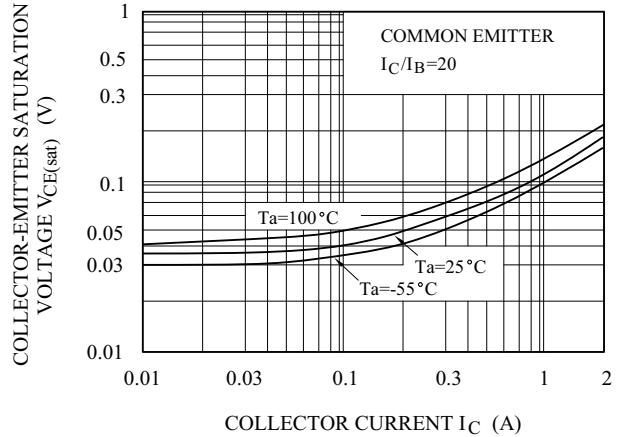

KTC2815D/L

SAFE OPERATING AREA

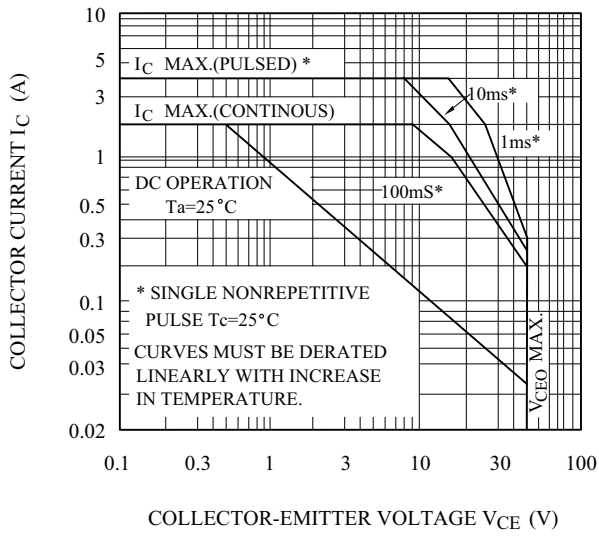

$P_c - T_a$

