

2SD2259

Silicon NPN epitaxial planer type

For low-frequency amplification

■ Features

- High forward current transfer ratio h_{FE} .
- Low collector to emitter saturation voltage $V_{CE(sat)}$.
- Allowing supply with the radial taping.

■ Absolute Maximum Ratings (Ta=25°C)

Parameter	Symbol	Ratings	Unit
Collector to base voltage	V_{CBO}	20	V
Collector to emitter voltage	V_{CEO}	20	V
Emitter to base voltage	V_{EBO}	15	V
Peak collector current	I_{CP}	1.5	A
Collector current	I_C	0.7	A
Collector power dissipation	P_C^*	1	W
Junction temperature	T_j	150	°C
Storage temperature	T_{stg}	-55 ~ +150	°C

* Printed circuit board: Copper foil area of 1cm² or more, and the board thickness of 1.7mm for the collector portion

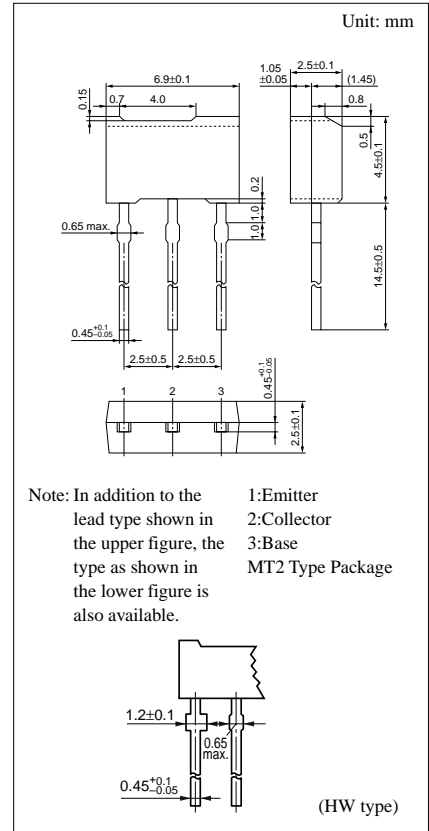

■ Electrical Characteristics (Ta=25°C)

Parameter	Symbol	Conditions	min	typ	max	Unit
Collector cutoff current	I_{CBO}	$V_{CB} = 15V, I_E = 0$			1	μA
	I_{CEO}	$V_{CE} = 15V, I_B = 0$			10	μA
Collector to base voltage	V_{CBO}	$I_C = 10\mu A, I_E = 0$	20			V
Collector to emitter voltage	V_{CEO}	$I_C = 1mA, I_B = 0$	20			V
Emitter to base voltage	V_{EBO}	$I_E = 10\mu A, I_C = 0$	15			V
Forward current transfer ratio	h_{FE}	$V_{CE} = 10V, I_C = 150mA^*$	1000		2500	
Collector to emitter saturation voltage	$V_{CE(sat)}$	$I_C = 500mA, I_B = 50mA^*$		0.15	0.4	V
Transition frequency	f_T	$V_{CB} = 20V, I_E = -20mA, f = 200MHz$		55		MHz
Collector output capacitance	C_{ob}	$V_{CB} = 10V, I_E = 0, f = 1MHz$		10	15	pF

*2 Pulse measurement

$P_C - T_a$

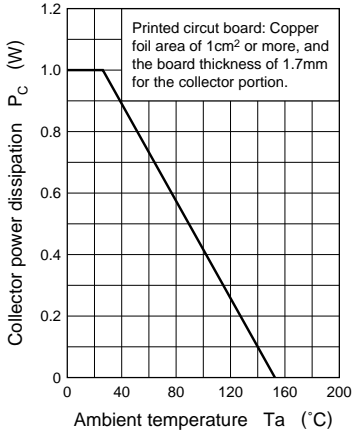

$I_C - V_{CE}$

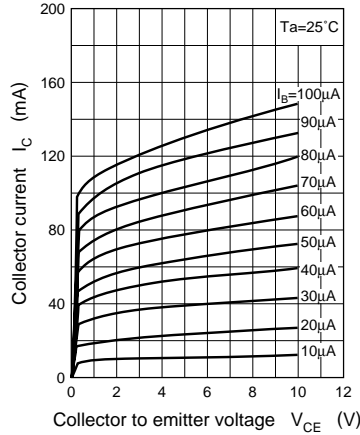

$I_C - V_{BE}$

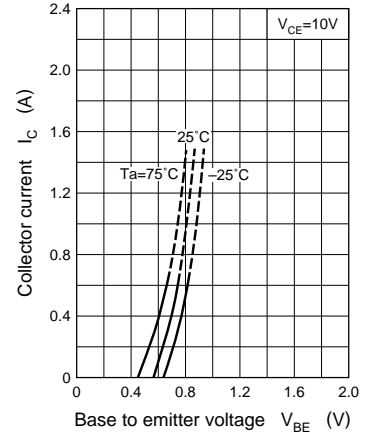

$V_{CE(sat)} - I_C$

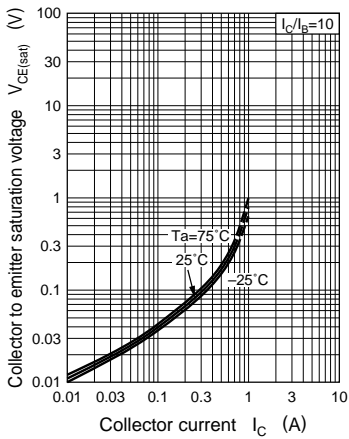

$h_{FE} - I_C$

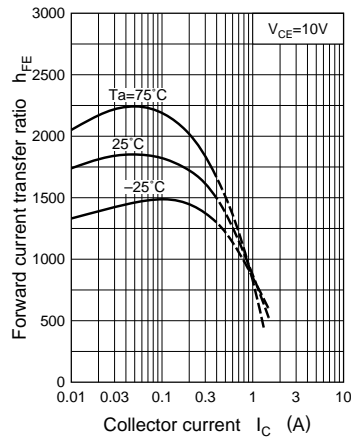

$f_T - I_E$

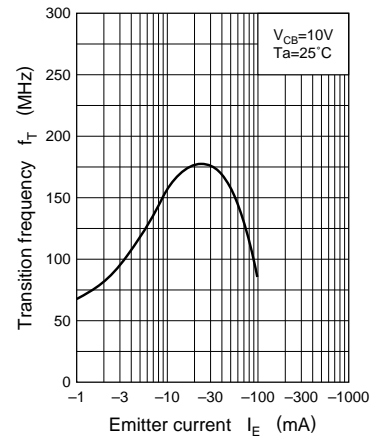

$C_{ob} - V_{CB}$

