

TOSHIBA Transistor Silicon PNP Epitaxial Type (PCT Process)

RN2007, RN2008, RN2009

Switching, Inverter Circuit, Interface Circuit
And Driver Circuit Applications

- With built-in bias resistors
- Simplify circuit design
- Reduce a quantity of parts and manufacturing process
- Complementary to RN1007~RN1009

Equivalent Circuit and Bias Resister Values

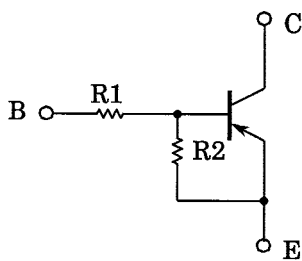

Type No.	R1 (kΩ)	R2 (kΩ)
RN2007	10	47
RN2008	22	47
RN2009	47	22

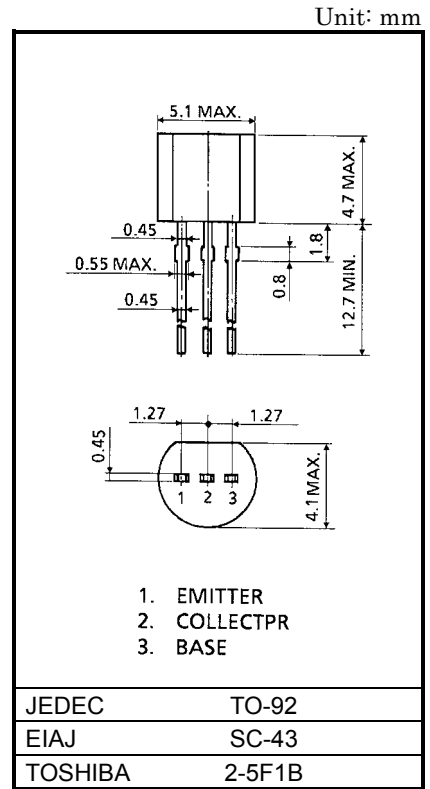

Weight: 0.21g

Maximum Ratings (Ta = 25°C)

Characteristic	Symbol	Rating	Unit
Collector-base voltage	V_{CBO}	-50	V
Collector-emitter voltage	V_{CEO}	-50	V
Emitter-base voltage	RN2007	-6	V
	RN2008	-7	
	RN2009	-15	
Collector current	I_C	-100	mA
Collector power dissipation	P_C	400	mW
Junction temperature	T_j	150	°C
Storage temperature range	T_{stg}	-55~150	°C

Electrical Characteristics (Ta = 25°C)

Characteristic		Symbol	Test Circuit	Test Condition	Min	Typ.	Max	Unit
Collector cut-off current		I_{CBO}	—	$V_{CB} = -50V, I_E = 0$	—	—	-100	nA
		I_{CEO}		$V_{CE} = -50V, I_B = 0$	—	—	-500	
Emitter cut-off current	RN2007	I_{EBO}	—	$V_{EB} = -6V, I_C = 0$	-0.081	—	-0.15	mA
	RN2008			$V_{EB} = -7V, I_C = 0$	-0.078	—	-0.145	
	RN2009			$V_{EB} = -15V, I_C = 0$	-0.167	—	-0.311	
DC current gain	RN2007	h_{FE}	—	$V_{CE} = -5V,$ $I_C = -10mA$	80	—	—	
	RN2008				80	—	—	
	RN2009				70	—	—	
Collector-emitter saturation voltage		$V_{CE(sat)}$	—	$I_C = -5mA,$ $I_B = -0.25mA$	—	-0.1	-0.3	V
Input voltage (ON)	RN2007	$V_{I(ON)}$	—	$V_{CE} = -0.2V,$ $I_C = -5mA$	-0.7	—	-1.8	V
	RN2008				-1.0	—	-2.6	
	RN2009				-2.2	—	-5.8	
Input voltage (OFF)	RN2007	$V_{I(OFF)}$	—	$V_{CE} = -5V,$ $I_C = -0.1mA$	-0.5	—	-1.0	V
	RN2008				-0.6	—	-1.16	
	RN2009				-1.5	—	-2.6	
Transition frequency		f_T	—	$V_{CE} = -10V,$ $I_C = -5mA$	—	200	—	MHz
Collector Output capacitance		C_{ob}	—	$V_{CB} = -10V, I_E = 0,$ $f = 1MHz$	—	3	6	pF
Input resistor	RN2007	R1	—		7	10	13	kΩ
	RN2008				15.4	22	28.6	
	RN2009				32.9	47	61.1	
Resistor ratio	RN2007	R1/R2	—		0.191	0.213	0.232	
	RN2008				0.421	0.468	0.515	
	RN2009				1.92	2.14	2.35	

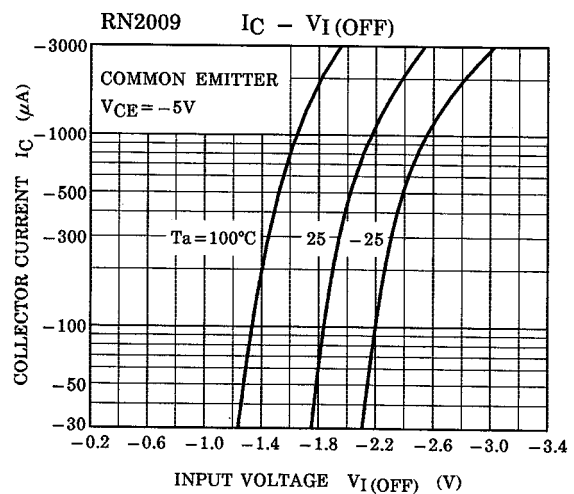
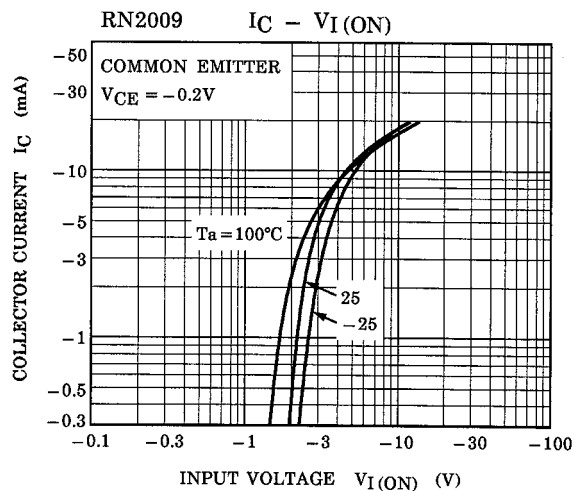
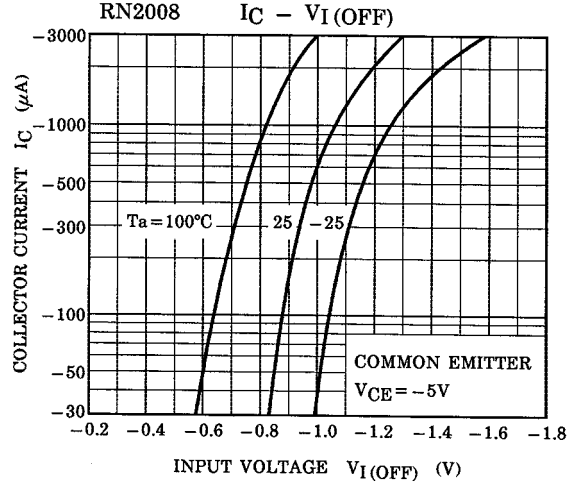
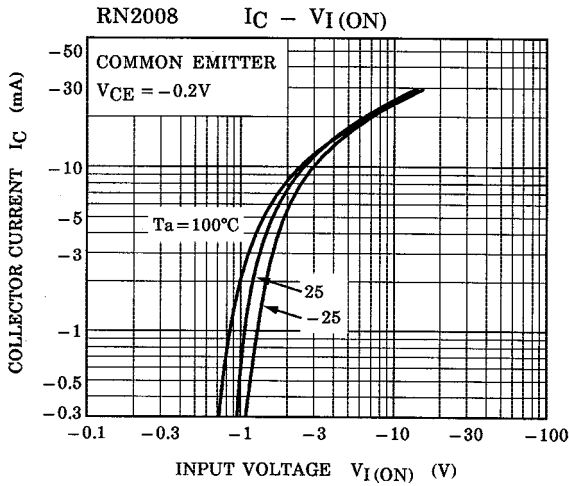
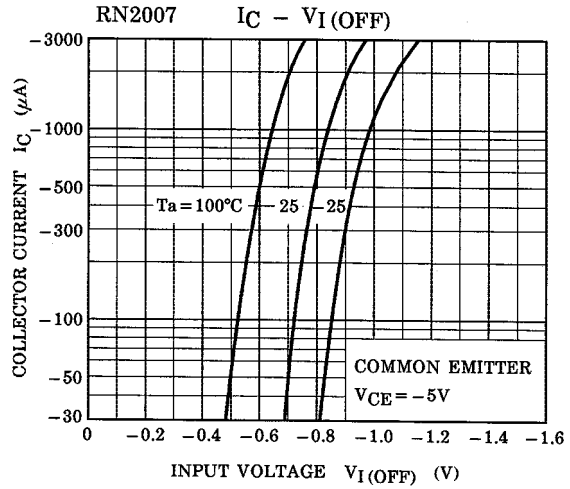
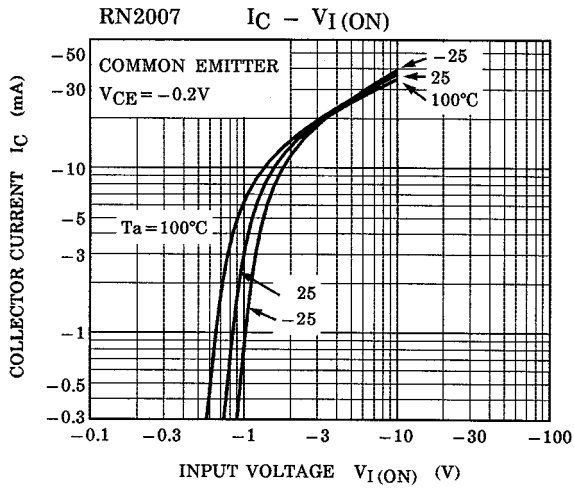

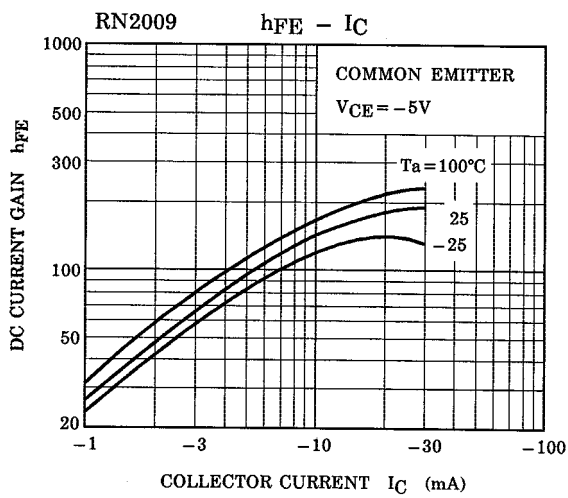
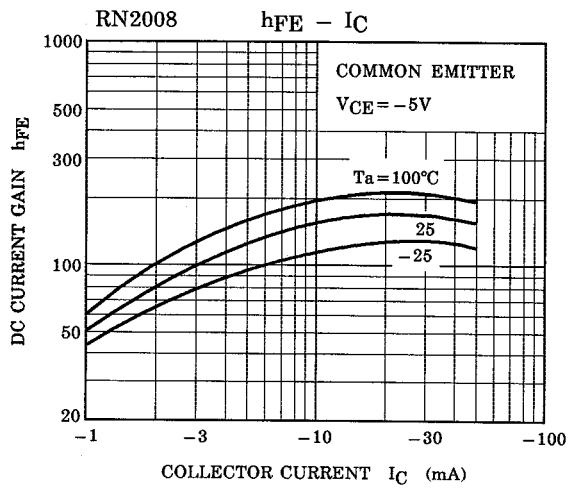
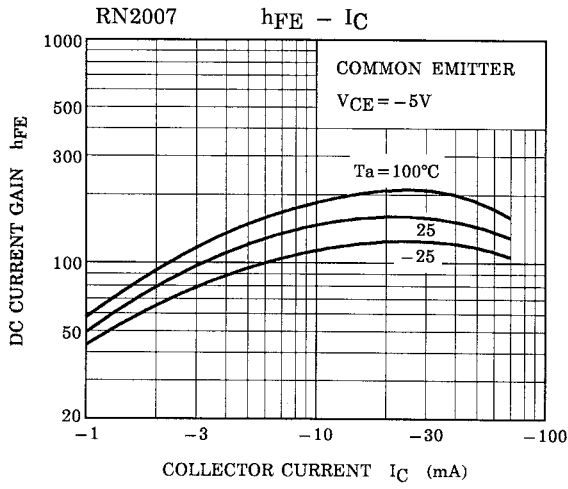

RESTRICTIONS ON PRODUCT USE

000707EAA

- TOSHIBA is continually working to improve the quality and reliability of its products. Nevertheless, semiconductor devices in general can malfunction or fail due to their inherent electrical sensitivity and vulnerability to physical stress. It is the responsibility of the buyer, when utilizing TOSHIBA products, to comply with the standards of safety in making a safe design for the entire system, and to avoid situations in which a malfunction or failure of such TOSHIBA products could cause loss of human life, bodily injury or damage to property.
In developing your designs, please ensure that TOSHIBA products are used within specified operating ranges as set forth in the most recent TOSHIBA products specifications. Also, please keep in mind the precautions and conditions set forth in the "Handling Guide for Semiconductor Devices," or "TOSHIBA Semiconductor Reliability Handbook" etc..
- The TOSHIBA products listed in this document are intended for usage in general electronics applications (computer, personal equipment, office equipment, measuring equipment, industrial robotics, domestic appliances, etc.). These TOSHIBA products are neither intended nor warranted for usage in equipment that requires extraordinarily high quality and/or reliability or a malfunction or failure of which may cause loss of human life or bodily injury ("Unintended Usage"). Unintended Usage include atomic energy control instruments, airplane or spaceship instruments, transportation instruments, traffic signal instruments, combustion control instruments, medical instruments, all types of safety devices, etc.. Unintended Usage of TOSHIBA products listed in this document shall be made at the customer's own risk.
- The information contained herein is presented only as a guide for the applications of our products. No responsibility is assumed by TOSHIBA CORPORATION for any infringements of intellectual property or other rights of the third parties which may result from its use. No license is granted by implication or otherwise under any intellectual property or other rights of TOSHIBA CORPORATION or others.
- The information contained herein is subject to change without notice.