

T-77-07-05

# SL 1431/2

## TV IF PREAMPLIFIERS WITH AGC GENERATOR

The SL1431 and SL1432 are fixed gain IF pre-amplifiers for television with a differential output optimised for driving Plessey surface acoustic wave (SAW) filters. Besides providing the necessary gain block between the tuner and SAW filter they also supply a properly derived, broadband AGC signal to the tuner, the SL1431 providing the correct sense signal for a NPN tuner, and the SL1432 for an PNP tuner. The tuner AGC threshold is internally preset to a value to allow adequate signal handling in the SL1431 and SL1432 and does not normally require any external adjustment. However, to account for the large variations in signal handling capability which is encountered on some tuners, the tuner AGC threshold may be externally adjusted by altering the bias on pin 1.

Both devices feature on-chip decoupling for a minimum external component count.

### AGC Signal

For high input signal levels the voltage on pin 7 goes low with SL1431 and high with the SL1432.

### QUICK REFERENCE DATA

- 23dB Gain at 40MHz
- 12V Supply at 25mA
- 120mV R.M.S. Input Handling
- 15mA Tuner AGC Capability

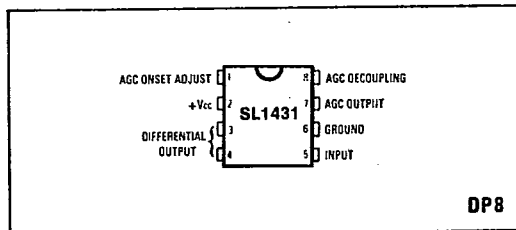

Fig. 1 Pin connections - top view

### FEATURES

- Properly Derived Tuner AGC
- Low Cost
- Low Noise
- Low External Component Count
- Low Distortion
- Direct 12V Operation
- Can be used with Different Types of SAW Filters

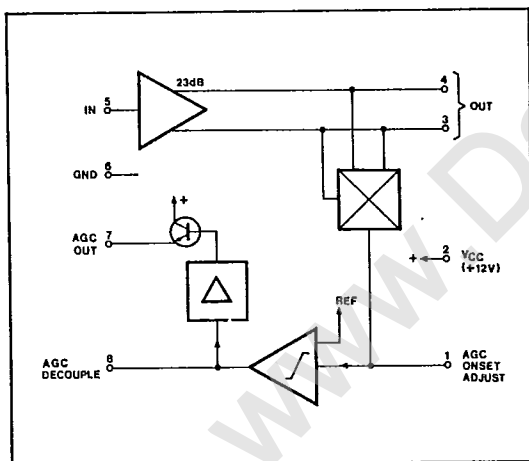

Fig. 2 Block diagram

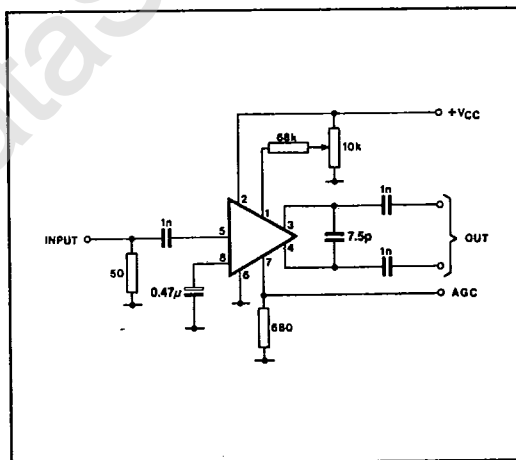

Fig. 3 Test circuit

**ELECTRICAL CHARACTERISTICS**

Test conditions (unless otherwise stated):

- T<sub>amb</sub> = +25°C
- Supply voltage = +12V
- Frequency = 40MHz
- Output load = 7.5pF (Pins 3 and 4)
- Measurements made using test circuit Fig. 3.

T-77-07-05

Characteristic	Pin	Value			Units	Conditions
		Min.	Typ.	Max.		
Supply Voltage	2	7	12	13.5	V	Pins o/c
Quiescent Current	2	22	33	40	mA	
Cut-off frequency (-3dB)	5	60	110		MHz	
Voltage gain		20	23	26	dB	
Input signal for 46dB intermodulation	5		120		mV	Red colour bar (wanted level 20mV,, unwanted modulation 65%)
Input signal for 1% cross-modulation	5		75		mV	
Input signal for 1dB sync tip compression	5	130			mVrms	
Noise figure	5		4		dB	
Input impedance	5		300Ω //4.2pF			
<b>Tuner AGC</b>						
Output current	7	15	20		mA	@ 10.0 V
Input impedance	1		6		kΩ	

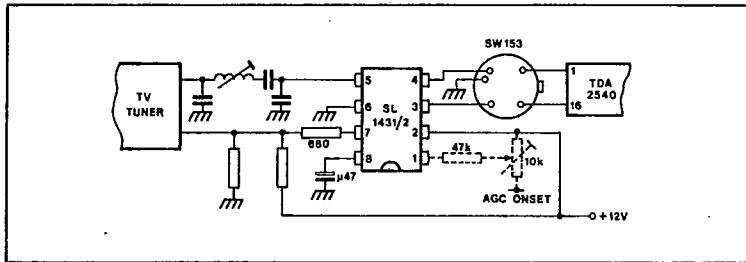

Fig. 4 Typical applications

SL1431 TYPICAL CHARACTERISTICS AT 12V, +25°C, WITH SW173 AS LOAD (7.5pF)  
 (FIGS. 5 TO 10) Unwanted signal with 65% amplitude modulation at 10kHz

T-77-07-05

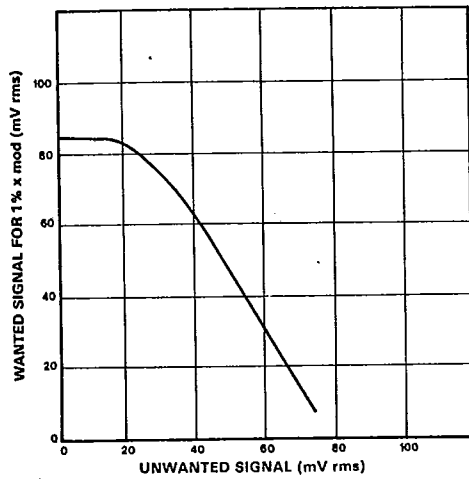

Fig. 5 Cross modulation performance (see note 1)

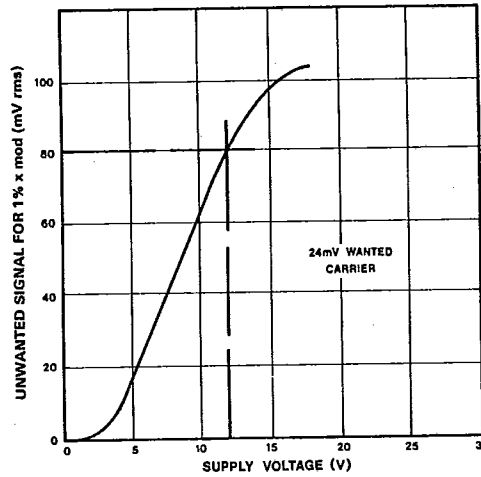

Fig. 6 Cross modulation performance V supply voltage (see note 1)

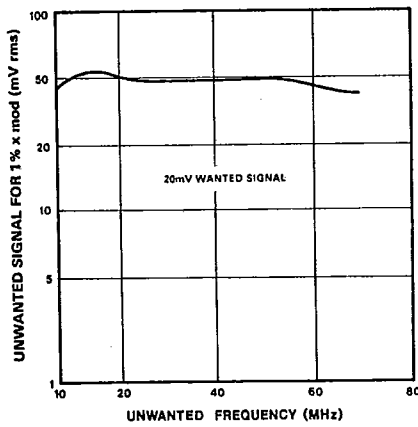

Fig. 7 Cross modulation performance V frequency of unwanted signal (see note 1)

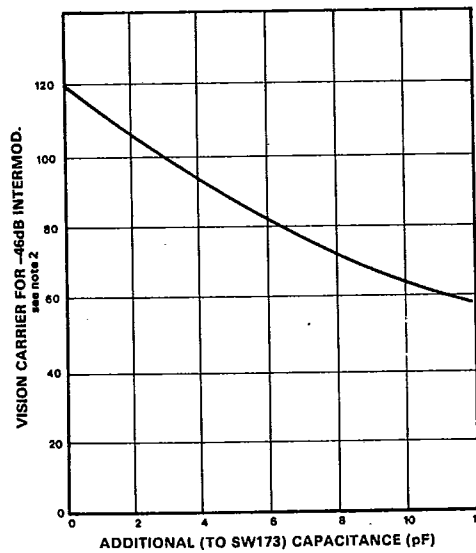

Fig. 8 Intermodulation performance v. load capacitance

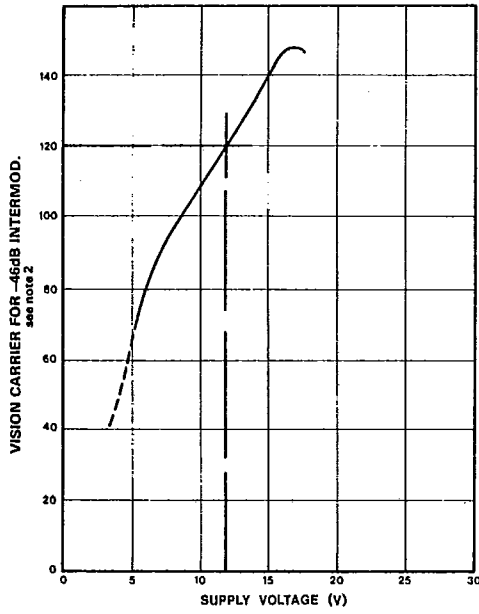

Fig. 9 Intermodulation performance v. supply voltage

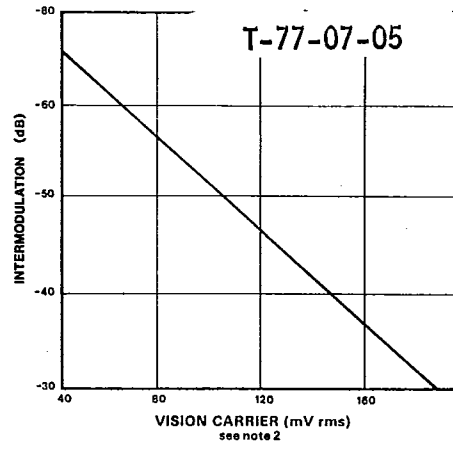

Fig. 10 Intermodulation performance (see note 2)

NOTE 1. Signal level refers to peak rms. i.e. The effective sync. tip level of a composite video signal.

NOTE 2. The test signal employed corresponds to the red bar of a transmitted colour bar and consists of the following elements related to the sync. tip level, the vision carrier at 38.9MHz-6dB, the colour carrier at 34.5MHz-18dB, and the sound carrier at 33.4MHz-7dB.

**ABSOLUTE MAXIMUM RATINGS**

- Supply voltage                    -0.5V to +25V
- Operating temperature range    -10°C to +65°C
- Storage temperature range      -55°C to +125°C