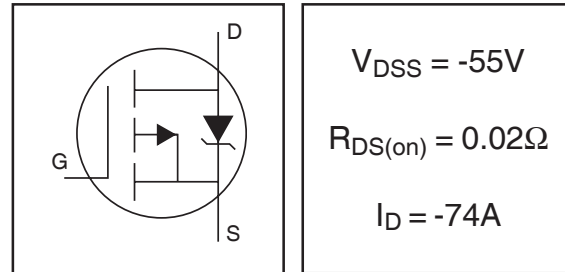


# IRF4905PbF

HEXFET® Power MOSFET

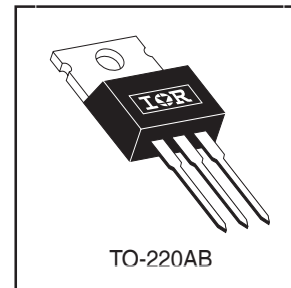
- Advanced Process Technology
- Ultra Low On-Resistance
- Dynamic dv/dt Rating
- 175°C Operating Temperature
- Fast Switching
- P-Channel
- Fully Avalanche Rated
- Lead-Free



## Description

Fifth Generation HEXFETs from International Rectifier utilize advanced processing techniques to achieve extremely low on-resistance per silicon area. This benefit, combined with the fast switching speed and ruggedized device design that HEXFET Power MOSFETs are well known for, provides the designer with an extremely efficient and reliable device for use in a wide variety of applications.

The TO-220 package is universally preferred for all commercial-industrial applications at power dissipation levels to approximately 50 watts. The low thermal resistance and low package cost of the TO-220 contribute to its wide acceptance throughout the industry.



## Absolute Maximum Ratings

|                                 | Parameter  | Max.               | Units |
|---------------------------------|--|--------------------|-------|
| $I_D @ T_C = 25^\circ\text{C}$  | Continuous Drain Current, $V_{GS} @ -10\text{V}$ | -74                | A     |
| $I_D @ T_C = 100^\circ\text{C}$ | Continuous Drain Current, $V_{GS} @ -10\text{V}$ | -52                |       |
| $I_{DM}$                        | Pulsed Drain Current ①                           | -260               |       |
| $P_D @ T_C = 25^\circ\text{C}$  | Power Dissipation                                | 200                | W     |
|                                 | Linear Derating Factor                           | 1.3                | W/°C  |
| $V_{GS}$                        | Gate-to-Source Voltage                           | $\pm 20$           | V     |
| $E_{AS}$                        | Single Pulse Avalanche Energy②                   | 930                | mJ    |
| $I_{AR}$                        | Avalanche Current③                               | -38                | A     |
| $E_{AR}$                        | Repetitive Avalanche Energy④                     | 20                 | mJ    |
| dv/dt                           | Peak Diode Recovery dv/dt ⑤                      | -5.0               | V/ns  |
| $T_J$                           | Operating Junction and                           | -55 to +175        | °C    |
| $T_{STG}$                       | Storage Temperature Range                        |                    |       |
|                                 | Soldering Temperature, for 10 seconds            |                    |       |
|                                 | Mounting torque, 6-32 or M3 screw                | 10 lbf•in (1.1N•m) |       |

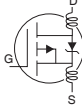
## Thermal Resistance

|                 | Parameter                           | Typ. | Max. | Units |
|-----------------|-------------------------------------|------|------|-------|
| $R_{\theta JC}$ | Junction-to-Case                    | —    | 0.75 | °C/W  |
| $R_{\theta CS}$ | Case-to-Sink, Flat, Greased Surface | 0.50 | —    |       |
| $R_{\theta JA}$ | Junction-to-Ambient                 | —    | 62   |       |

# IRF4905PbF

International  
IR Rectifier

## Electrical Characteristics @ $T_J = 25^\circ\text{C}$ (unless otherwise specified)

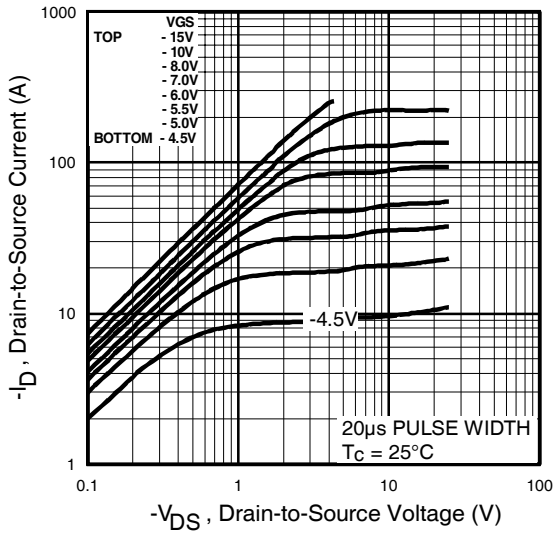
|                                 | Parameter                            | Min. | Typ.  | Max. | Units    | Conditions   |
|---------------------------------|--------------------------------------|------|-------|------|----------|--|
| $V_{(BR)DSS}$                   | Drain-to-Source Breakdown Voltage    | -55  | —     | —    | V        | $V_{GS} = 0V, I_D = -250\mu A$   |
| $\Delta V_{(BR)DSS}/\Delta T_J$ | Breakdown Voltage Temp. Coefficient  | —    | -0.05 | —    | V/°C     | Reference to $25^\circ\text{C}, I_D = -1\text{mA}$                                   |
| $R_{DS(on)}$                    | Static Drain-to-Source On-Resistance | —    | —     | 0.02 | $\Omega$ | $V_{GS} = -10V, I_D = -38A$ ④  |
| $V_{GS(th)}$                    | Gate Threshold Voltage               | -2.0 | —     | -4.0 | V        | $V_{DS} = V_{GS}, I_D = -250\mu A$   |
| $g_{fs}$                        | Forward Transconductance             | 21   | —     | —    | S        | $V_{DS} = -25V, I_D = -38A$  |
| $I_{DSS}$                       | Drain-to-Source Leakage Current      | —    | —     | -25  | $\mu A$  | $V_{DS} = -55V, V_{GS} = 0V$   |
|                                 |                                      | —    | —     | -250 |          | $V_{DS} = -44V, V_{GS} = 0V, T_J = 150^\circ\text{C}$                                |
| $I_{GSS}$                       | Gate-to-Source Forward Leakage       | —    | —     | 100  | nA       | $V_{GS} = 20V$   |
|                                 | Gate-to-Source Reverse Leakage       | —    | —     | -100 |          | $V_{GS} = -20V$  |
| $Q_g$                           | Total Gate Charge                    | —    | —     | 180  | nC       | $I_D = -38A$   |
| $Q_{gs}$                        | Gate-to-Source Charge                | —    | —     | 32   |          | $V_{DS} = -44V$  |
| $Q_{gd}$                        | Gate-to-Drain ("Miller") Charge      | —    | —     | 86   |          | $V_{GS} = -10V$ , See Fig. 6 and 13 ④  |
| $t_{d(on)}$                     | Turn-On Delay Time                   | —    | 18    | —    | ns       | $V_{DD} = -28V$  |
| $t_r$                           | Rise Time                            | —    | 99    | —    |          | $I_D = -38A$   |
| $t_{d(off)}$                    | Turn-Off Delay Time                  | —    | 61    | —    |          | $R_G = 2.5\Omega$  |
| $t_f$                           | Fall Time                            | —    | 96    | —    |          | $R_D = 0.72\Omega$ , See Fig. 10 ④   |
| $L_D$                           | Internal Drain Inductance            | —    | 4.5   | —    | nH       | Between lead,<br>6mm (0.25in.)<br>from package<br>and center of die contact          |
| $L_S$                           | Internal Source Inductance           | —    | 7.5   | —    |          |  |
| $C_{iss}$                       | Input Capacitance                    | —    | 3400  | —    | pF       | $V_{GS} = 0V$  |
| $C_{oss}$                       | Output Capacitance                   | —    | 1400  | —    |          | $V_{DS} = -25V$  |
| $C_{rss}$                       | Reverse Transfer Capacitance         | —    | 640   | —    |          | $f = 1.0\text{MHz}$ , See Fig. 5   |

## Source-Drain Ratings and Characteristics

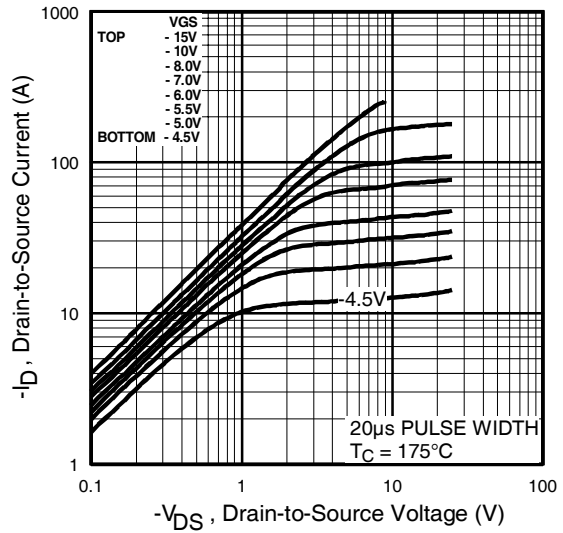
|          | Parameter                                 | Min.  | Typ. | Max. | Units | Conditions  |
|----------|---|---|------|------|-------|---|
| $I_S$    | Continuous Source Current<br>(Body Diode) | —   | —    | -74  | A     | MOSFET symbol<br>showing the<br>integral reverse<br>p-n junction diode. |
| $I_{SM}$ | Pulsed Source Current<br>(Body Diode) ①   | —   | —    | -260 |       |   |
| $V_{SD}$ | Diode Forward Voltage                     | —   | —    | -1.6 | V     | $T_J = 25^\circ\text{C}, I_S = -38A, V_{GS} = 0V$ ④                     |
| $t_{rr}$ | Reverse Recovery Time                     | —   | 89   | 130  | ns    | $T_J = 25^\circ\text{C}, I_F = -38A$                                    |
| $Q_{rr}$ | Reverse Recovery Charge                   | —   | 230  | 350  | nC    | $di/dt = -100A/\mu s$ ④   |
| $t_{on}$ | Forward Turn-On Time                      | Intrinsic turn-on time is negligible (turn-on is dominated by $L_S+L_D$ ) |      |      |       |   |

### Notes:

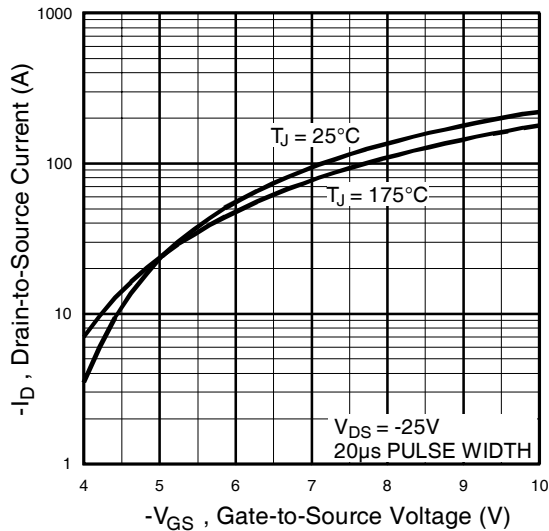
- ① Repetitive rating; pulse width limited by max. junction temperature. ( See fig. 11 )
- ② Starting  $T_J = 25^\circ\text{C}$ ,  $L = 1.3\text{mH}$   
 $R_G = 25\Omega, I_{AS} = -38A$ . (See Figure 12)
- ③  $I_{SD} \leq -38A, di/dt \leq -270A/\mu s, V_{DD} \leq V_{(BR)DSS}, T_J \leq 175^\circ\text{C}$
- ④ Pulse width  $\leq 300\mu s$ ; duty cycle  $\leq 2\%$ .



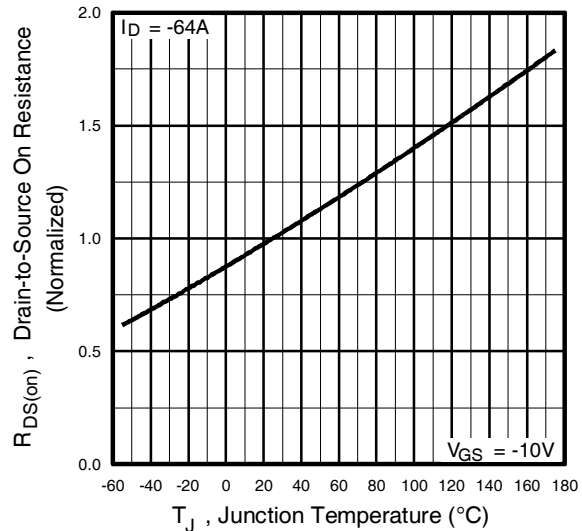
**Fig 1.** Typical Output Characteristics



**Fig 2.** Typical Output Characteristics



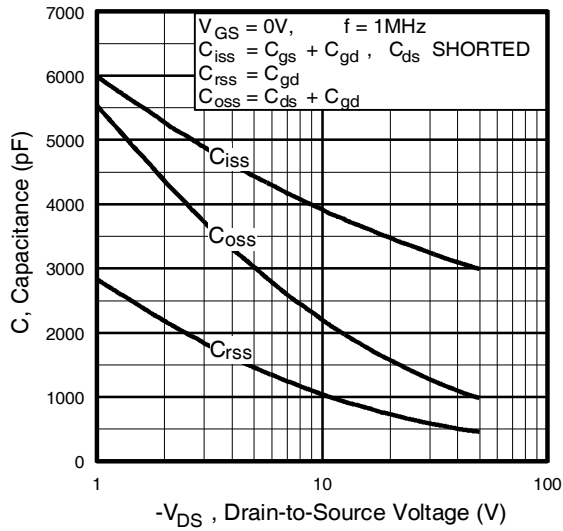
**Fig 3.** Typical Transfer Characteristics



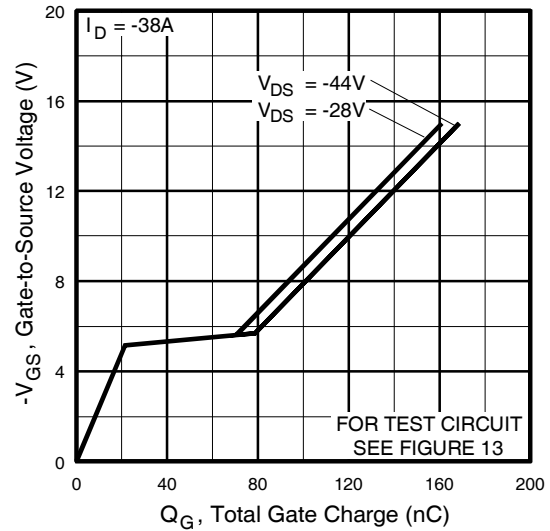
**Fig 4.** Normalized On-Resistance Vs. Temperature

# IRF4905PbF

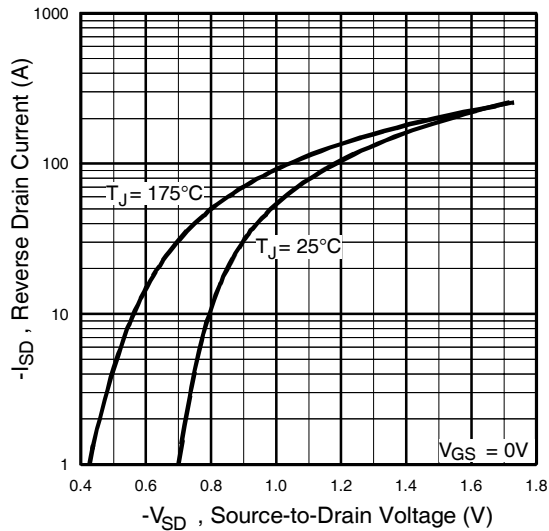
International  
**IR** Rectifier



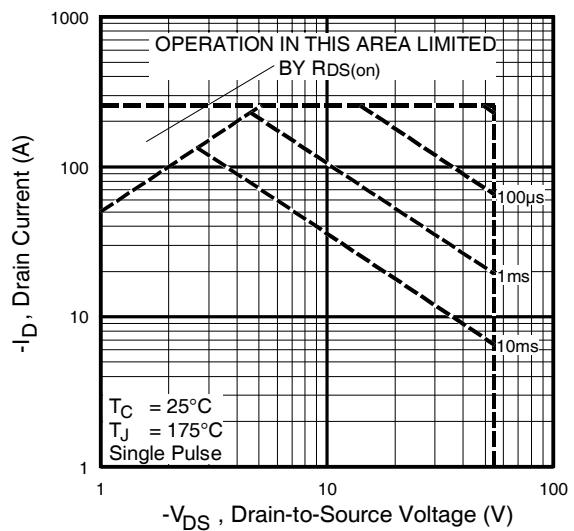
**Fig 5.** Typical Capacitance Vs. Drain-to-Source Voltage



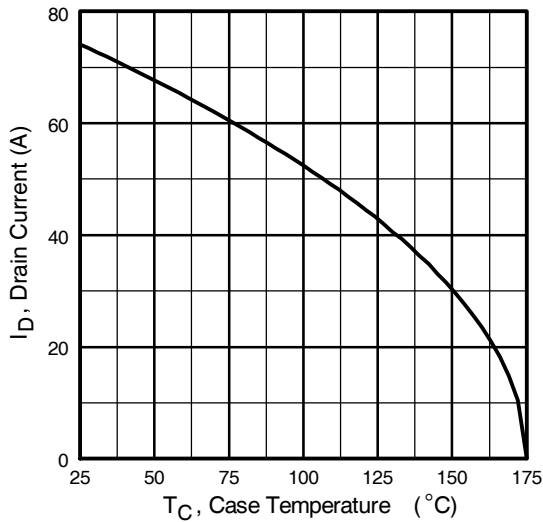
**Fig 6.** Typical Gate Charge Vs. Gate-to-Source Voltage



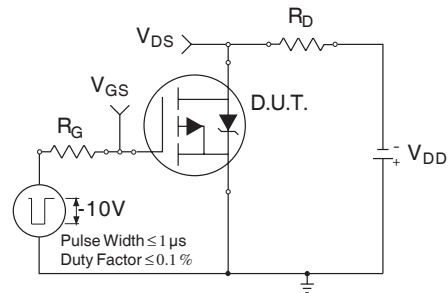
**Fig 7.** Typical Source-Drain Diode Forward Voltage



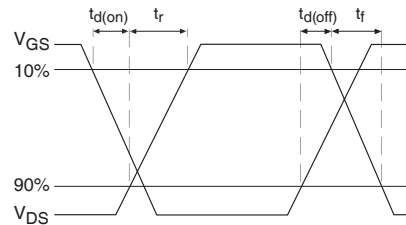
**Fig 8.** Maximum Safe Operating Area



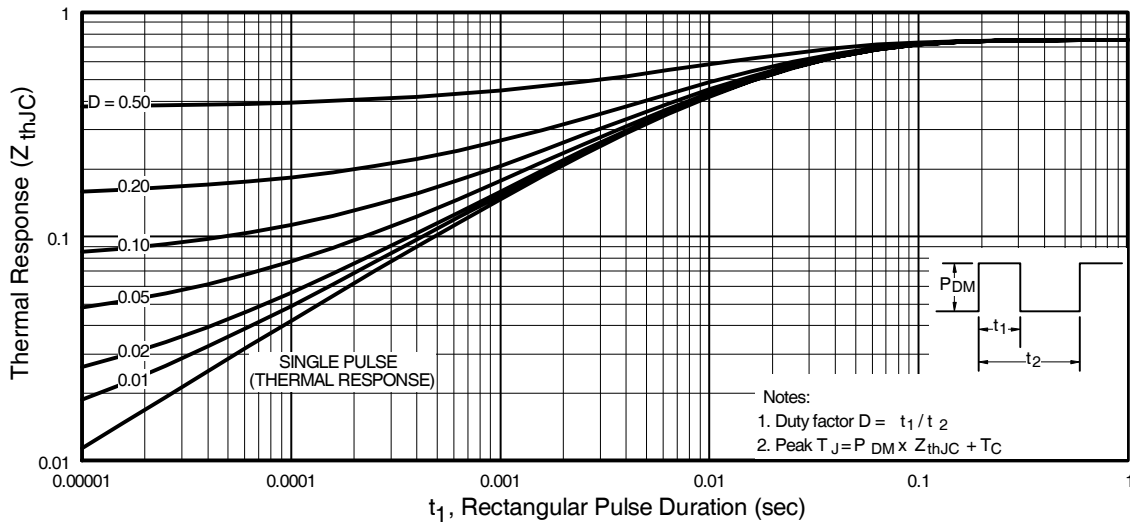
**Fig 9.** Maximum Drain Current Vs. Case Temperature



**Fig 10a.** Switching Time Test Circuit



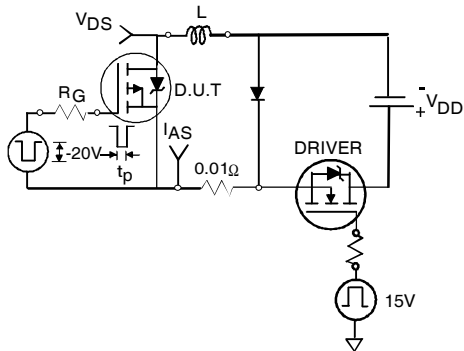
**Fig 10b.** Switching Time Waveforms



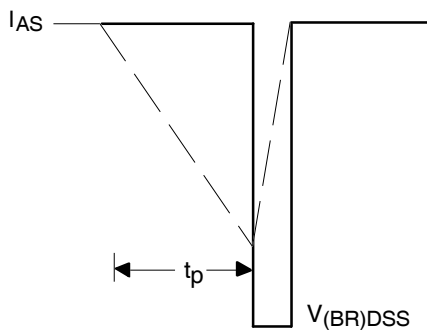
**Fig 11.** Maximum Effective Transient Thermal Impedance, Junction-to-Case

# IRF4905PbF

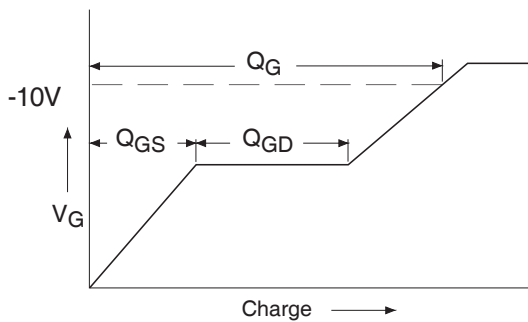
International  
**IR** Rectifier



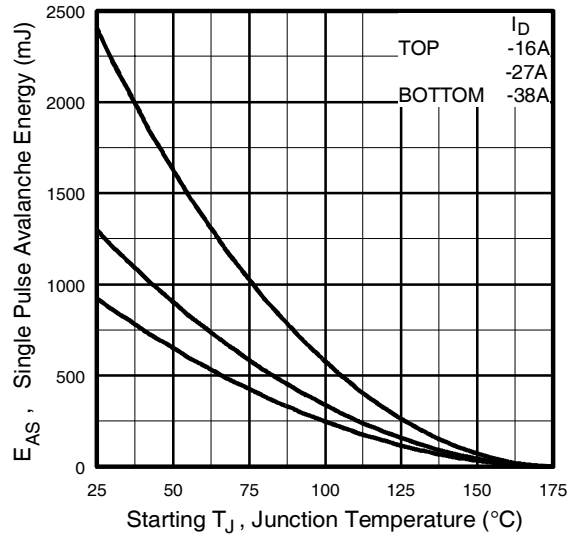
**Fig 12a.** Unclamped Inductive Test Circuit



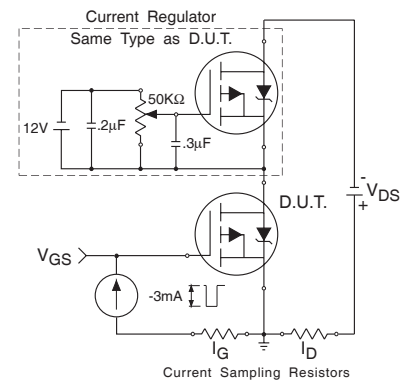
**Fig 12b.** Unclamped Inductive Waveforms



**Fig 13a.** Basic Gate Charge Waveform

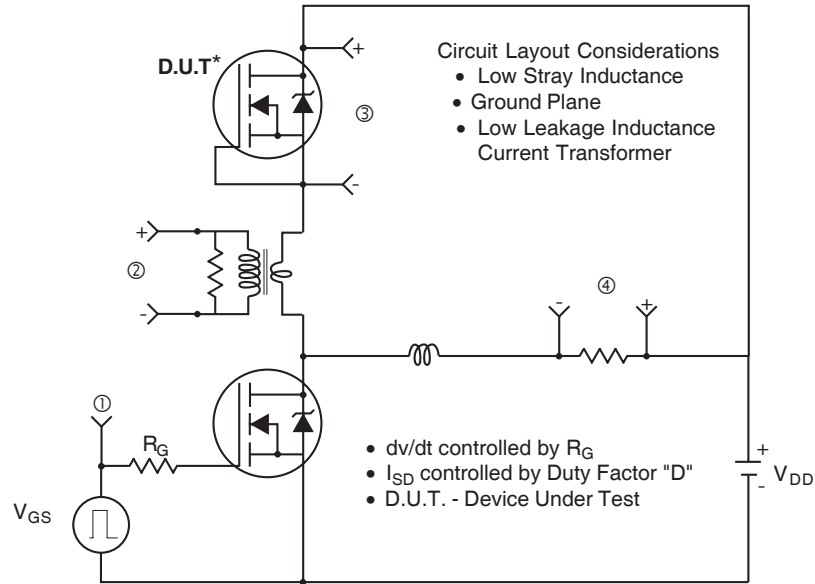


**Fig 12c.** Maximum Avalanche Energy Vs. Drain Current

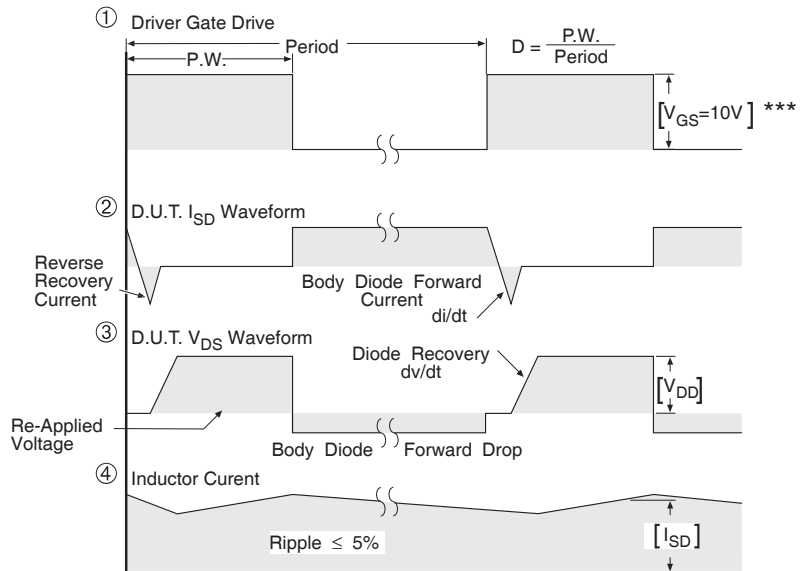


**Fig 13b.** Gate Charge Test Circuit

## Peak Diode Recovery dv/dt Test Circuit



\* Reverse Polarity of D.U.T for P-Channel



\*\*\*  $V_{GS} = 5.0V$  for Logic Level and 3V Drive Devices

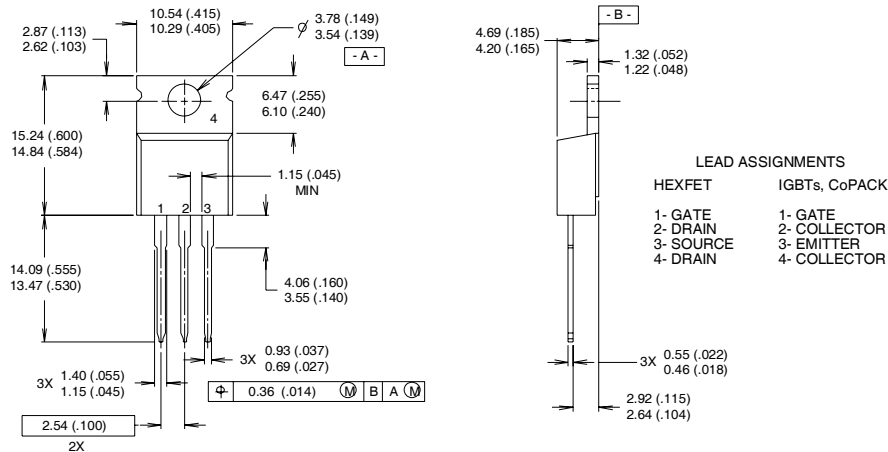
**Fig 14.** For P-Channel HEXFETS

# IRF4905PbF

International  
**IR** Rectifier

## TO-220AB Package Outline

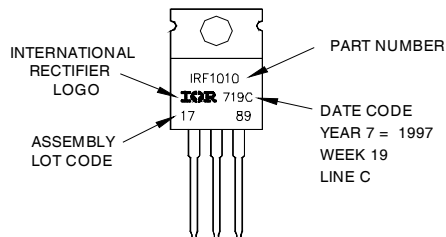
Dimensions are shown in millimeters (inches)



- NOTES:
- 1 DIMENSIONING & TOLERANCING PER ANSI Y14.5M, 1982.
  - 2 CONTROLLING DIMENSION : INCH
  - 3 OUTLINE CONFORMS TO JEDEC OUTLINE TO-220AB.
  - 4 HEATSINK & LEAD MEASUREMENTS DO NOT INCLUDE BURRS.

## TO-220AB Part Marking Information

EXAMPLE: THIS IS AN IRF1010  
 LOT CODE 1789  
 ASSEMBLED ON WW 19, 1997  
 IN THE ASSEMBLY LINE "C"  
**Note:** "P" in assembly line  
 position indicates "Lead-Free"



Data and specifications subject to change without notice.

International  
**IR** Rectifier

**IR WORLD HEADQUARTERS:** 233 Kansas St., El Segundo, California 90245, USA Tel: (310) 252-7105  
 TAC Fax: (310) 252-7903

Visit us at [www.irf.com](http://www.irf.com) for sales contact information.11/03