

AN1741 (AN6570), AN1741S (AN6570S), AN6573

Single Operational Amplifiers

Overview

The AN1741 (AN6570), the AN1741S (AN6570S), and the AN6573 are single-type operational amplifier with a phase compensation circuit built-in and also an output short-circuit protection circuit built-in, so that they are highly stable and can be used widely in various electronic circuits

Features

- Phase compensation circuit built-in
- High common mode input range, no latch-up
- Short circuit protection
- Low input offset voltage : $V_{I(\text{offset})} = 0.5\text{mV typ.}$
- Low input offset current : $I_{IO} = 10\text{nA typ.}$
- Offset null circuit

Block Diagrams

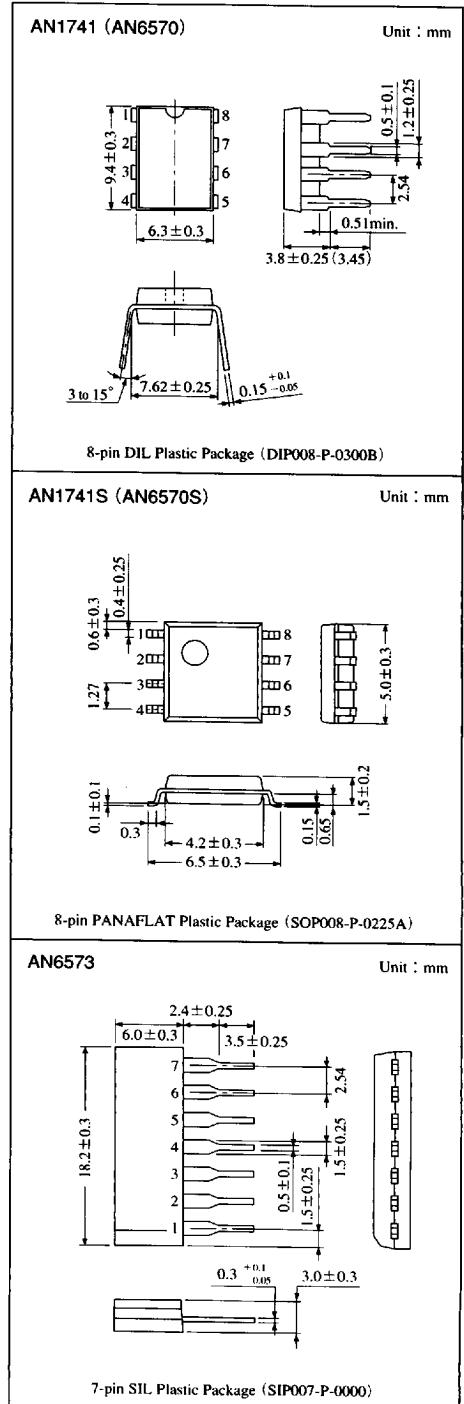
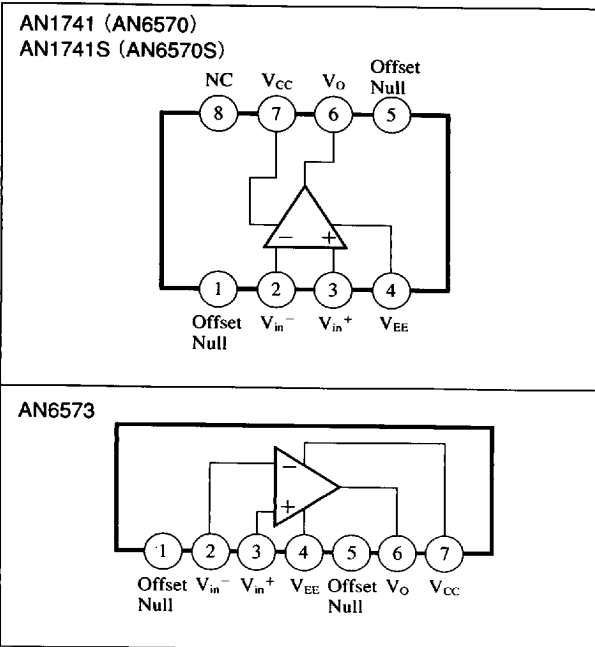

Operational Amplifiers

6932852 0012387 T79

Pin Descriptions

(AN1741 (AN6570), AN1741S (AN6570S))

Pin No.	Pin name
1	Offset Null
2	inverting input
3	Non inverting input
4	V_{EE}
5	Offset Null
6	Output
7	V_{CC}
8	NC

(AN6573)

Pin No.	Pin name
1	Offset Null
2	inverting input
3	Non inverting input
4	V_{EE}
5	Offset Null
6	Output
7	V_{CC}

Absolute Maximum Ratings ($T_a = 25^\circ\text{C}$)

Parameter		Symbol	Rating	Unit
Voltage	Supply voltage	V_{CC}	± 18	V
	Differential input voltage	V_{ID}	± 30	V
	Common-mode input voltage	V_{ICM}	± 15	V
Power dissipation	AN1741 (AN6570), AN6573	P_D	500	mW
	AN1741S (AN6570S)		360	
Operating ambient temperature		T_{opr}	-20 to $+75$	$^\circ\text{C}$
Storage temperature	AN1741 (AN6570), AN6573	T_{sig}	-55 to $+150$	$^\circ\text{C}$
	AN1741S (AN6570S)		-55 to $+125$	

Electrical Characteristics ($V_{CC} = 15\text{V}$, $V_{EE} = -15\text{V}$, $T_a = 25^\circ\text{C}$)

Parameter	Symbol	Condition	min	typ	max	Unit
Input offset voltage	$V_{I(\text{offset})}$	$R_S \leq 10\text{k}\Omega$	—	0.5	4	mV
Input offset current	I_{IO}		—	10	100	nA
Input bias current	I_{bias}		—	50	250	nA
Voltage gain	G_V	$R_L \geq 2\text{k}\Omega$, $V_O = \pm 10\text{V}$	86	106	—	dB
Maximum output voltage	$V_{O(\text{max.})}$	$R_L \geq 10\text{k}\Omega$	± 12	± 14	—	V
		$R_L \geq 2\text{k}\Omega$	± 10	± 13	—	V
Common-mode input voltage width	V_{CM}		± 12	± 13	—	V
Common-mode rejection ratio	CMR	$R_S \leq 10\text{k}\Omega$	70	90	—	dB
Supply voltage rejection ratio	SVR	$R_S \leq 10\text{k}\Omega$	—	30	150	$\mu\text{V/V}$
Supply current	I_{CC}	$R_L = \infty$	—	—	2.8	mA
Power consumption	P_C	$R_L = \infty$	—	—	85	mW
Output short-circuit current	$I_{O(\text{short})}$		—	± 20	—	mA
Slew rate	SR		—	0.7	—	V/ μs

6932852 0012388 905

Panasonic

■ Characteristics Curve

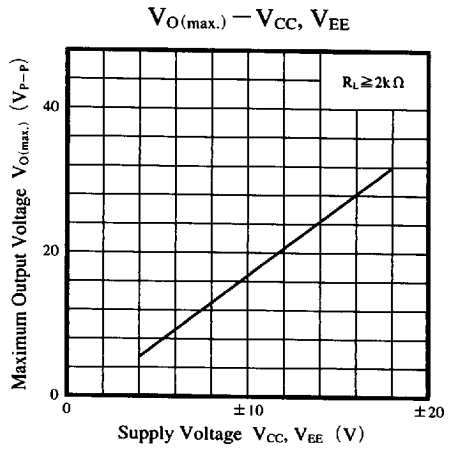
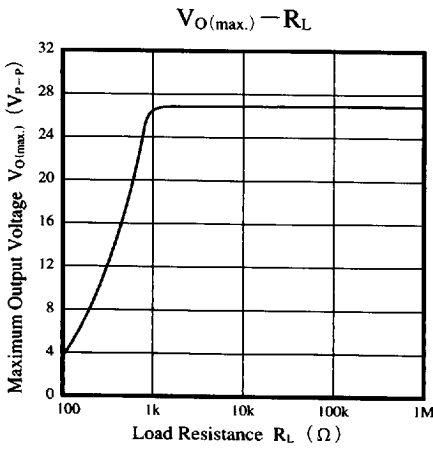
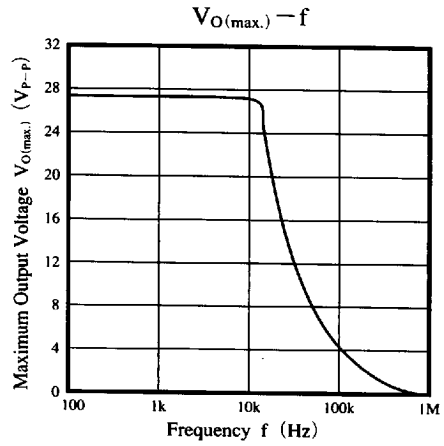
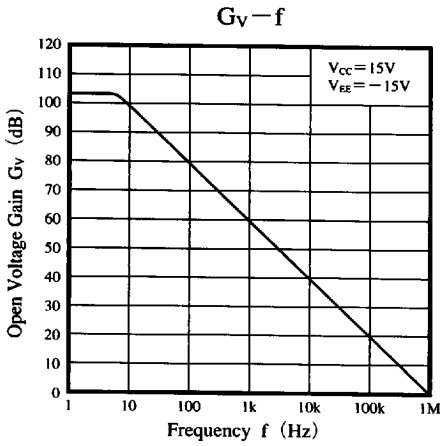

Operational Amplifiers

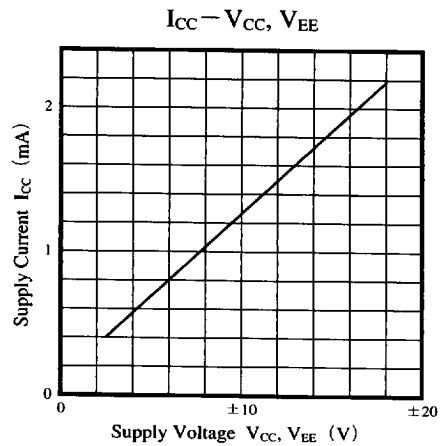
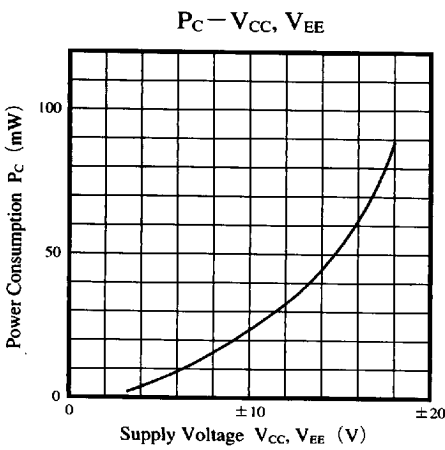

■ 6932852 0012389 841 ■

Panasonic

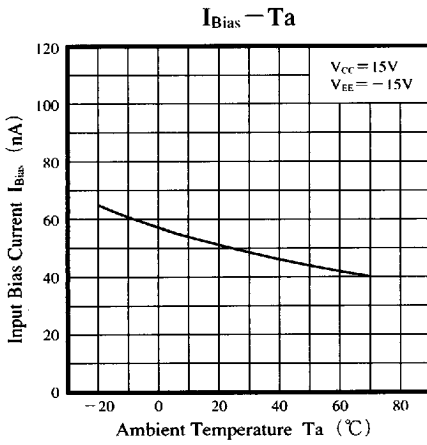
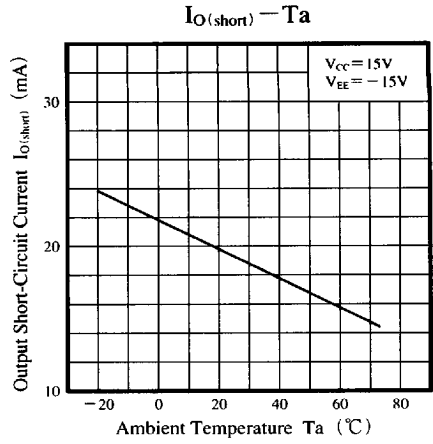
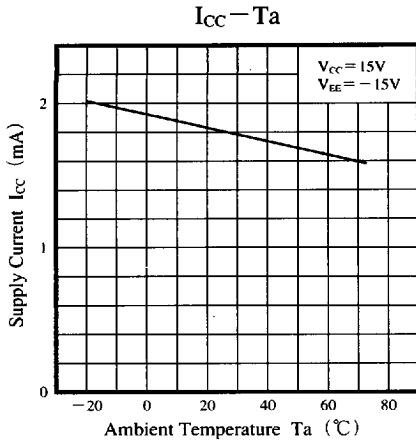

■ **Application Circuit**

Differential Amplifier

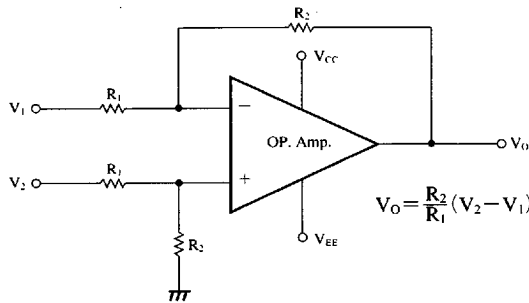

■ 6932852 0012390 563 ■

Panasonic