

Logic N-Channel MOSFET

Features

- Low $R_{DS(on)}$ (Max 0.018 Ω)@ $V_{GS}=10V$
 Low $R_{DS(on)}$ (Max 0.028 Ω)@ $V_{GS}=4.5V$
- Gate Charge (Typical 16nC)
- Maximum Junction Temperature Range (150°C)
- Available in Tape and Reel

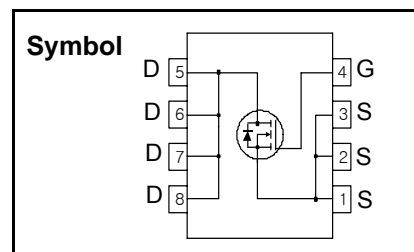

General Description

This Power MOSFET is produced using Semiwell's advanced planar stripe, DMOS technology. This latest technology has been especially designed to minimize on-state resistance, have a low gate charge with superior switching performance, and rugged avalanche characteristics. This Power MOSFET is well suited for power management circuit or DC-DC converter.

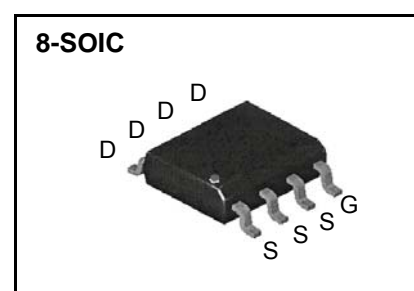

Absolute Maximum Ratings

Symbol	Parameter	Value	Units
V_{DSS}	Drain to Source Voltage	30	V
I_D	Continuous Drain Current(@ $T_A = 25^\circ C$)	9	A
I_{DM}	Drain Current Pulsed (Note 1)	50	A
V_{GS}	Gate to Source Voltage	± 20	V
P_D	Total Power Dissipation Single Operation ($T_A=25^\circ C$)	2.5	W
	Total Power Dissipation Single Operation ($T_A=70^\circ C$)	1.6	W
T_{STG}, T_J	Operating Junction Temperature & Storage Temperature	- 55 ~ 150	$^\circ C$
T_L	Maximum Lead Temperature for soldering purpose, 1/8 from Case for 10 seconds.	300	$^\circ C$

Thermal Characteristics

Symbol	Parameter	Value			Units
		Min.	Typ.	Max.	
$R_{\theta JA}$	Thermal Resistance, Junction-to-Ambient (Note 4)	-	-	50	$^\circ C/W$

SFS4416

Electrical Characteristics ($T_J = 25\text{ }^\circ\text{C}$ unless otherwise noted)

Symbol	Parameter	Test Conditions	Min	Typ	Max	Units
Off Characteristics						
BV_{DSS}	Drain-Source Breakdown Voltage	$V_{GS} = 0V, I_D = 250\mu A$	30	-	-	V
$\frac{\Delta BV_{DSS}}{\Delta T_J}$	Breakdown Voltage Temperature coefficient	$I_D = 250\mu A$, referenced to $25\text{ }^\circ\text{C}$	-	15	-	mV/ $^\circ\text{C}$
I_{DSS}	Drain-Source Leakage Current	$V_{DS} = 24V, V_{GS} = 0V$ $V_{DS} = 24V, V_{GS} = 0V, T_J = 55\text{ }^\circ\text{C}$	-	-	1 25	μA
I_{GSS}	Gate-Source Leakage, Forward	$V_{GS} = 20V, V_{DS} = 0V$	-	-	100	nA
	Gate-Source Leakage, Reverse	$V_{GS} = -20V, V_{DS} = 0V$	-	-	-100	nA
On Characteristics						
$V_{GS(th)}$	Gate Threshold Voltage	$V_{DS} = V_{GS}, I_D = 250\mu A$	1.0	-	-	V
$R_{DS(on)}$	Static Drain-Source On-state Resistance	$V_{GS} = 10V, I_D = 9A$ $V_{GS} = 4.5V, I_D = 7.3A$	- -	0.013 0.018	0.018 0.028	Ω
Dynamic Characteristics						
C_{iss}	Input Capacitance	$V_{GS} = 0V, V_{DS} = 15V, f = 1MHz$	-	920	-	pF
C_{oss}	Output Capacitance		-	490	-	
C_{rss}	Reverse Transfer Capacitance		-	150	-	
Dynamic Characteristics						
$t_{d(on)}$	Turn-on Delay Time	$V_{DD} = 15V, I_D = 1A, R_G = 50\Omega$ $V_{GS} = 10V$ (Note 2,3)	-	13	20	ns
t_r	Rise Time		-	23	50	
$t_{d(off)}$	Turn-off Delay Time		-	130	150	
t_f	Fall Time		-	65	100	
Q_g	Total Gate Charge	$V_{DS} = 15V, V_{GS} = 5V, I_D = 9A$ (Note 2,3)	-	16	20	nC
Q_{gs}	Gate-Source Charge		-	4	-	
Q_{gd}	Gate-Drain Charge(Miller Charge)		-	7.5	-	

Source-Drain Diode Ratings and Characteristics

Symbol	Parameter	Test Conditions	Min.	Typ.	Max.	Unit.
I_S	Continuous Source Diode Forward Current		-	-	2.1	A
V_{SD}	Diode Forward Voltage	$I_S = 2.1A, V_{GS} = 0V$ (Note 2)	-	-	1.2	V

※ NOTES

1. Repeatability rating : pulse width limited by junction temperature
2. Pulse Test : Pulse Width $\leq 300\mu s$, Duty Cycle $\leq 2\%$
3. Essentially independent of operating temperature.
4. Surface mounted on 1 inch² Cu board.



Fig 1. On-State Characteristics

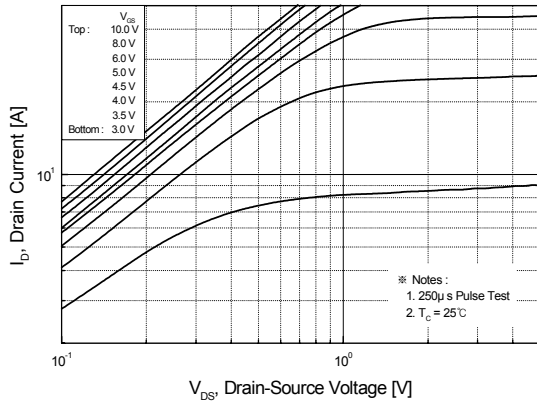

Fig 2. Transfer Characteristics

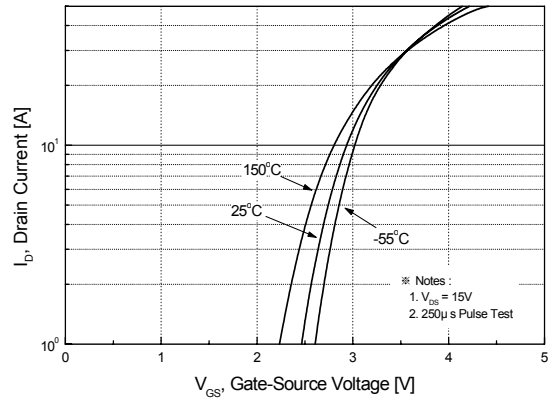

Fig 3. On Resistance Variation vs. Drain Current and Gate Voltage

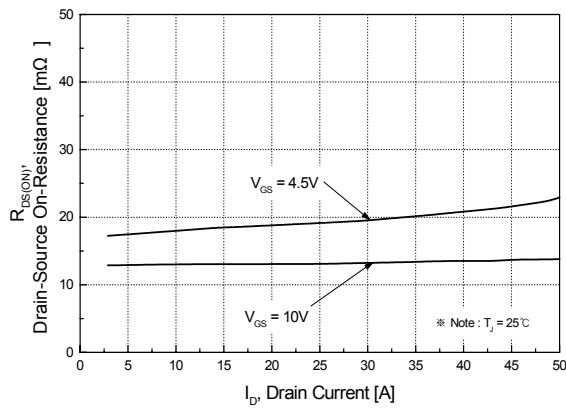

Fig 4. On State Current vs. Allowable Case Temperature

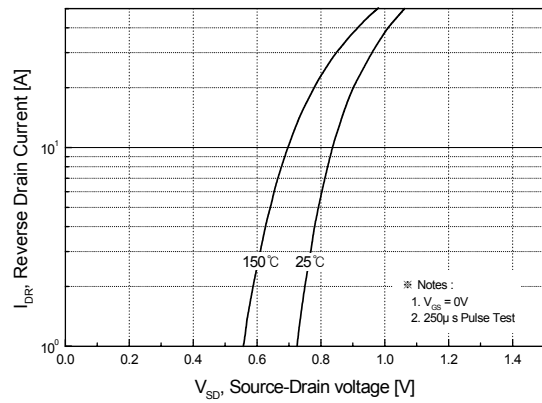

Fig 5. Capacitance Characteristics

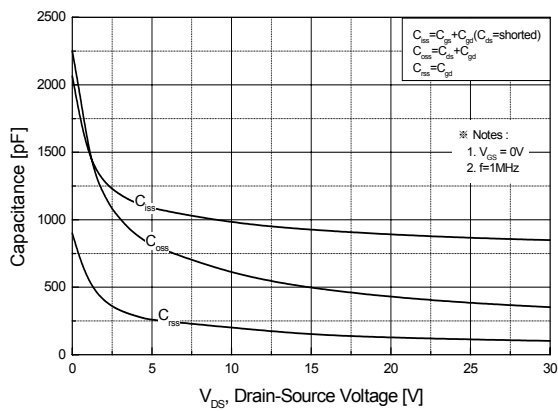

Fig 6. Gate Charge Characteristics

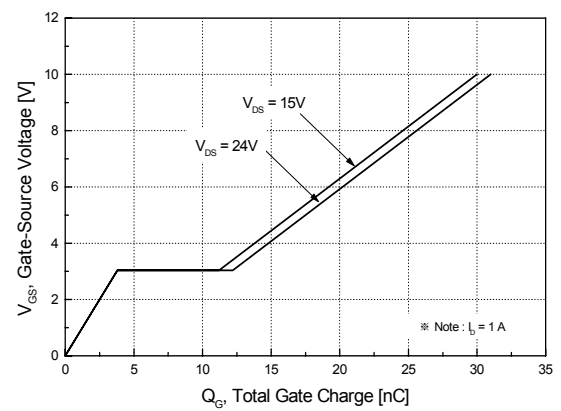

Fig 7. Breakdown Voltage Variation vs. Junction Temperature

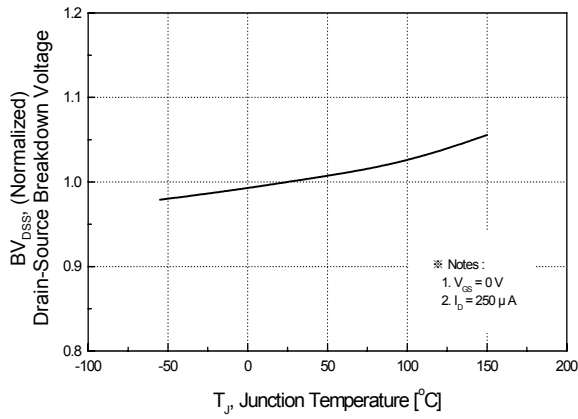

Fig 8. On-Resistance Variation vs. Junction Temperature

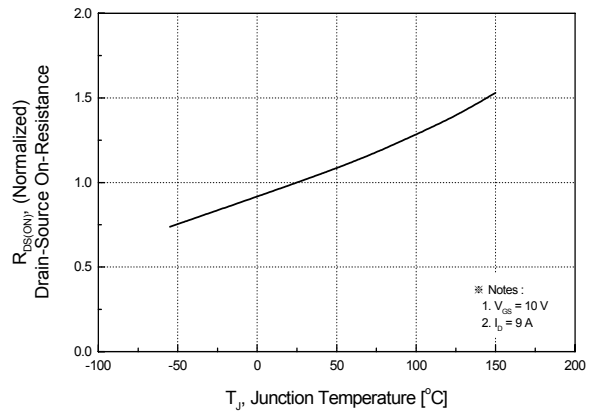

Fig 9. Normalized Transient Thermal Response Curve

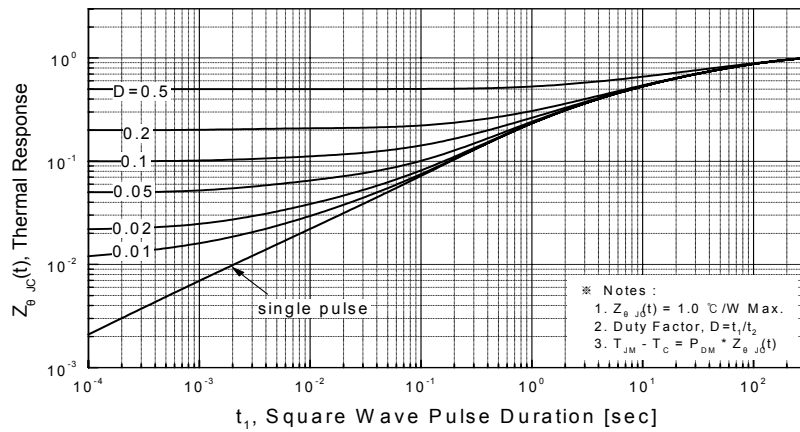

Fig. 10. Gate Charge Test Circuit & Waveforms

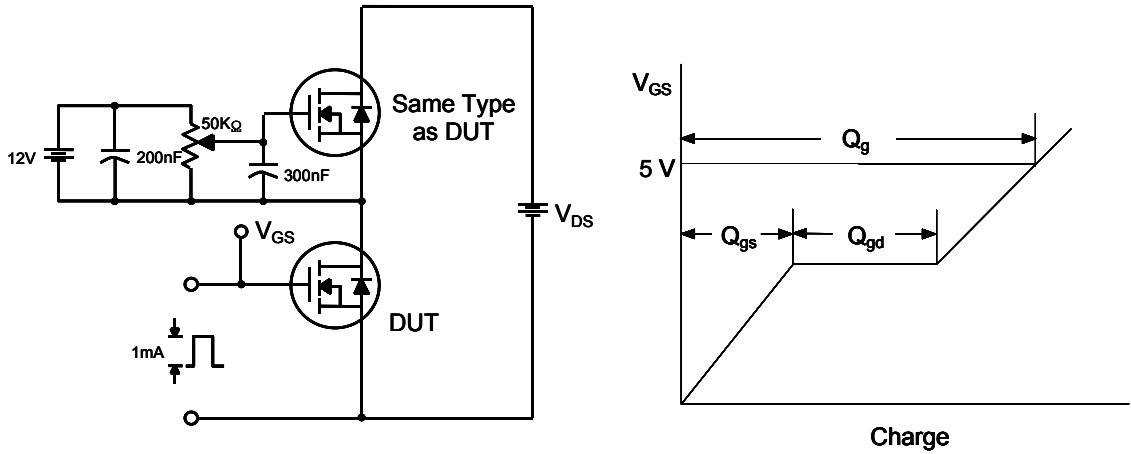
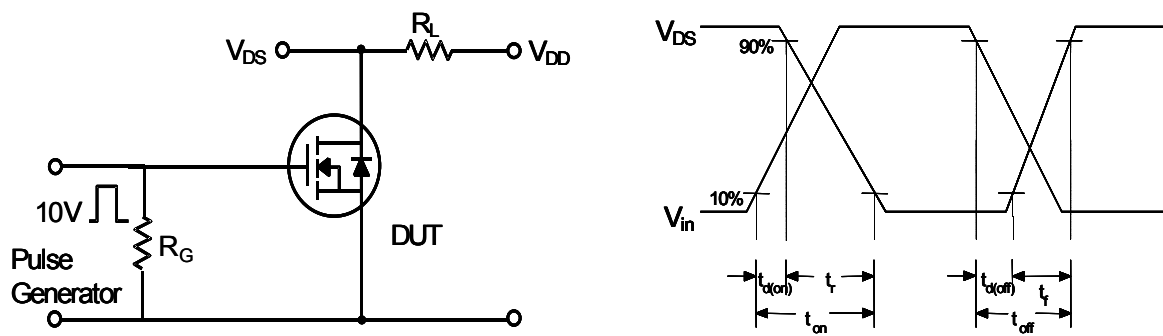

Fig. 11. Switching Time Test Circuit & Waveforms



SFS4416

8-SOIC Package Dimension

Dim.	mm			Inch		
	Min.	Typ.	Max.	Min.	Typ.	Max.
A	1.35	1.55	1.75	0.053	0.061	0.069
B	0.1	0.175	0.25	0.004	0.007	0.010
C	0.38	0.445	0.510	0.015	0.018	0.020
D	0.19	0.22	0.25	0.007	0.009	0.010
E	4.8	4.9	5	0.189	0.193	0.197
F	3.8	3.9	4	0.150	0.154	0.157
G	1.27 BSC					
H	5.8	6	6.2	0.228	0.236	0.244
I	0.5	0.715	0.93	0.020	0.028	0.037
J	0'	4'	8'	0'	4'	8'
K	0.250	0.375	0.05	0.010	0.015	0.020

