

# SBL2030CT AND SBL2040CT

## SCHOTTKY RECTIFIER

Reverse Voltage - 30 and 40 Volts      Forward Current - 20.0 Amperes

### TO-220AB

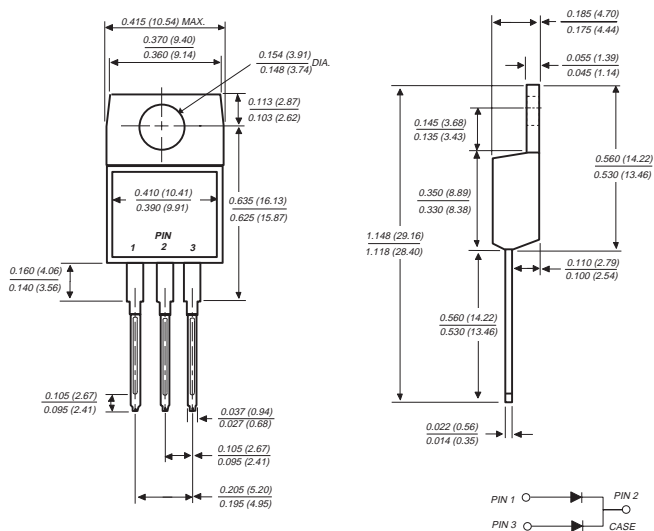

Dimensions in inches and (millimeters)

### FEATURES

- ◆ Plastic package has Underwriters Laboratory Flammability Classifications 94V-0
- ◆ Metal silicon junction, majority carrier conduction
- ◆ Low power loss, high efficiency
- ◆ High current capability, low forward voltage drop
- ◆ High surge capability
- ◆ For use in low voltage, high frequency inverters, free wheeling, and polarity protection applications
- ◆ Dual rectifier construction, positive center-tap
- ◆ Guardring for overvoltage protection
- ◆ High temperature soldering guaranteed: 250°C/10 seconds, 0.17" (4.3mm) from case

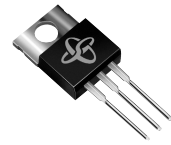

### MECHANICAL DATA

**Case:** JEDEC TO-220AB molded plastic  
**Terminals:** Leads solderable per MIL-STD-750, Method 2026  
**Polarity:** As marked  
**Mounting Position:** Any  
**Mounting Torque:** 5 in. - lbs.max.  
**Weight:** 0.08 ounce, 2.24 grams

### MAXIMUM RATINGS AND ELECTRICAL CHARACTERISTICS

Ratings at 25°C ambient temperature unless otherwise specified.

	SYMBOLS	SBL2030CT	SBL2040CT	UNITS
Maximum repetitive peak reverse voltage	V <sub>RRM</sub>	30	40	Volts
Maximum RMS voltage	V <sub>RMS</sub>	21	28	Volts
Maximum DC blocking voltage	V <sub>DC</sub>	30	40	Volts
Maximum average forward rectified current at T <sub>C</sub> =105°C	I(AV)	20.0		Amps
Peak forward surge current, 8.3ms single half sine-wave superimposed on rated load (JEDEC Method)	I <sub>FSM</sub>	175.0		Amps
Peak repetitive reverse surge current (NOTE 3)	I <sub>RRM</sub>	1.0		Amp
Maximum instantaneous forward voltage per leg at 10.0A (NOTE 1)	V <sub>F</sub>	0.55		Volts
Maximum instantaneous current at rated DC blocking voltage per leg (NOTE 1) T <sub>C</sub> =25°C T <sub>C</sub> =100°C	I <sub>R</sub>	1.0 50.0		mA
Typical thermal resistance per leg (NOTE 2)	R <sub>θJC</sub>	2.0		°C/W
Operating junction and storage temperature range	T <sub>J</sub> , T <sub>STG</sub>	-40 to +125		°C

#### NOTES:

- (1) Pulse test: 300μs pulse width, 1% duty cycle
- (2) Thermal resistance from junction to case per leg
- (3) 2.0μs pulse width, f=1.0 KHz

# RATINGS AND CHARACTERISTIC CURVES SBL2030CT AND SBL2040CT

FIG. 1 - FORWARD CURRENT DERATING CURVE

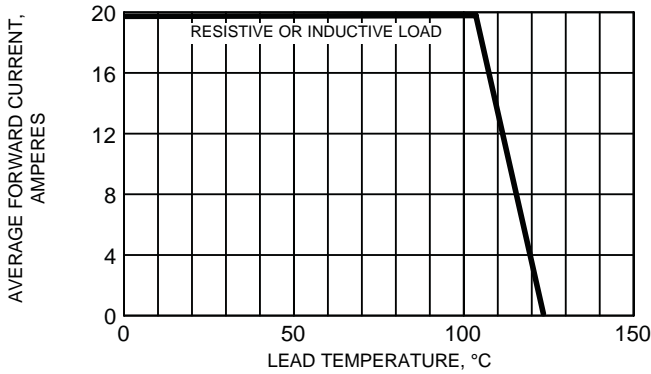

FIG. 2 - MAXIMUM NON-REPETITIVE PEAK FORWARD SURGE CURRENT PER LEG

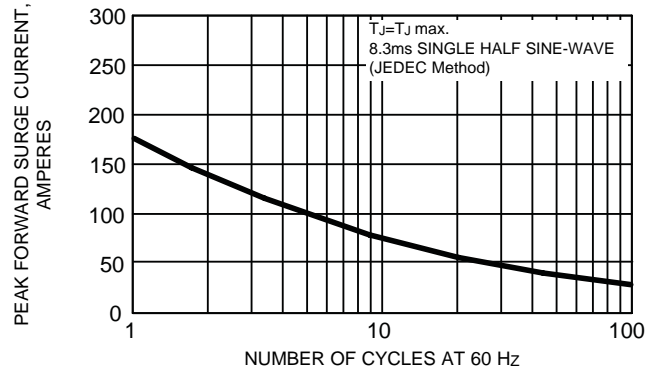

FIG. 3 - TYPICAL INSTANTANEOUS FORWARD CHARACTERISTICS PER LEG

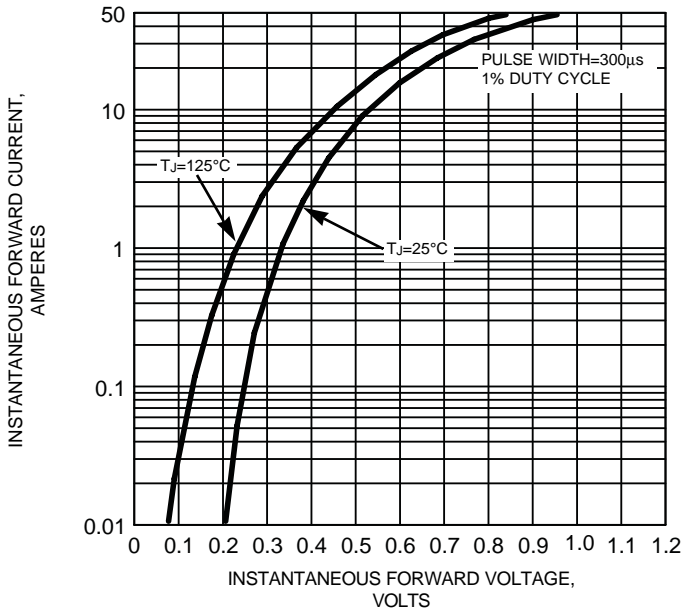

FIG. 4 - TYPICAL REVERSE CHARACTERISTICS PER LEG

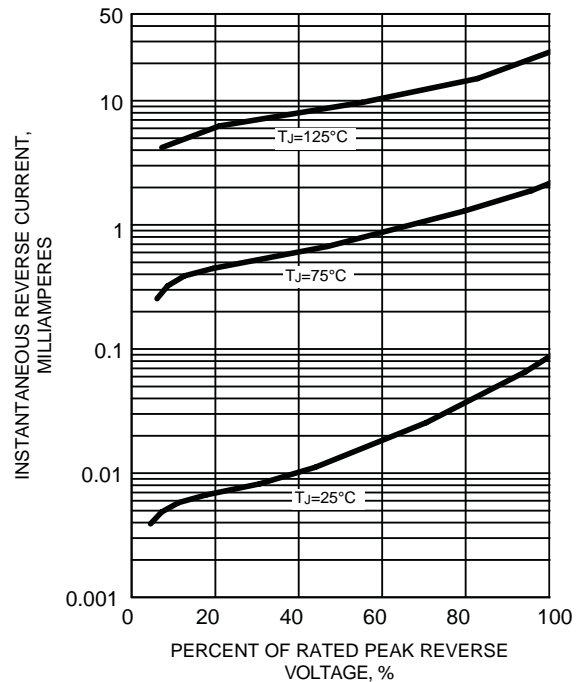

FIG. 5 - TYPICAL JUNCTION CAPACITANCE PER LEG

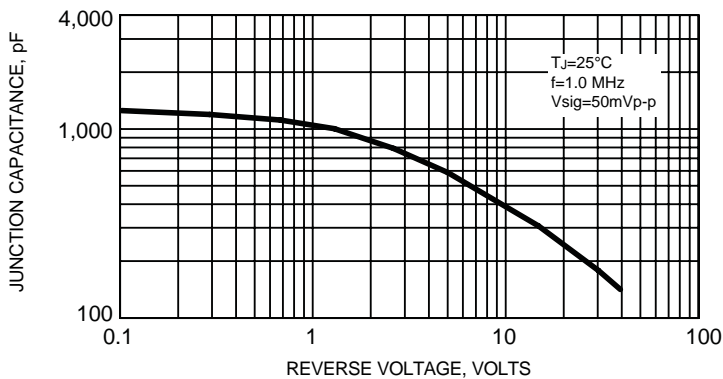

FIG. 6 - TYPICAL TRANSIENT THERMAL IMPEDANCE PER LEG

