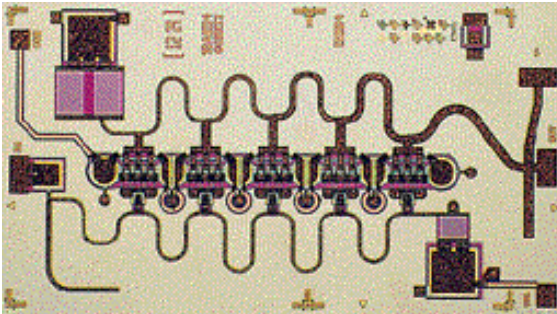

**2 - 20 GHz Power Amplifier****TGA8334-SCC****Key Features and Performance**

- 2 to 20 GHz Frequency Range
- 0.4-W Output Power at 1 dB Gain Compression at Midband
- Positive Gain Slope Across Frequency
- On-Chip Input DC-Blocking Capacitor
- 1.8:1 Input SWR at Midband, 1.3:1 Output SWR at Midband
- 8 dB Gain with +/- 1 dB Flatness
- 3.1750 x 1.8034 x 0.1524 mm (0.125 x 0.071 x 0.006 in.)

**Description**

The TriQuint TGA8334-SCC is a GaAs monolithic dual-gate distributed amplifier. Small-signal gain is typically 8 dB with positive gain slope across the band. Input and output return loss is typically greater than 9.7 dB. Five 600um gatewidth FETs provide more than 26 dB output power at 1 dB gain compression at midband. Ground is provided to the circuitry through vias to the backside metallization.

The TGA8334-SCC is directly cascadable with other broadband TriQuint GaAs amplifiers, such as the TGA8300-SCC, TGA8622-SCC, and TGA8220-SCC. This general power amplifier is suitable for a variety of wide-band applications such as distributed networks, logging stages and oscillator buffers.

Bond pad and backside metallization is gold plated for compatibility with eutectic alloy attachment methods as well as the thermocompression and thermosonic wire bonding processes. The TGA8334-SCC is supplied in chip form and is readily assembled using automated equipment.

**TYPICAL  
OUTPUT POWER**  
 $P_{1dB}$

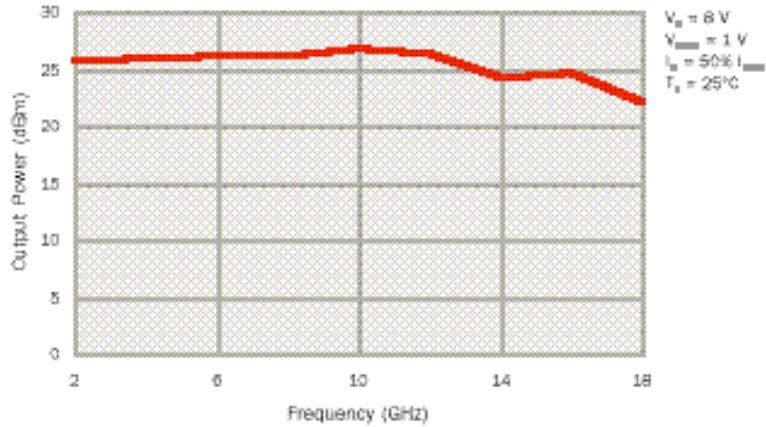

**TYPICAL  
SMALL-SIGNAL  
POWER GAIN**

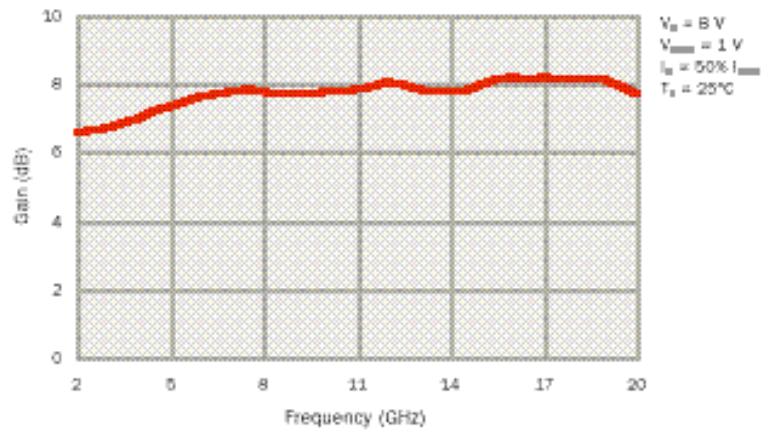

**TYPICAL  
RETURN LOSS**

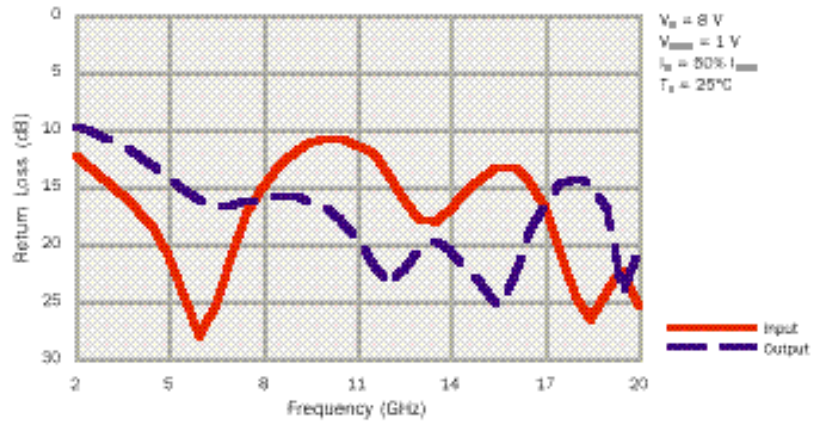

**ABSOLUTE  
MAXIMUM  
RATINGS**

---

Positive supply voltage, V+.....	9 V
Positive supply current, I+.....	I <sub>bss</sub>
Negative supply voltage range, V-.....	-5 V to 0 V
Gain control voltage range, V <sub>CTRL</sub> .....	-5 V to 4 V
Gain control voltage range with respect to positive supply voltage, V <sub>CTRL</sub> .....	0 V to -10 V
Power dissipation, P <sub>D</sub> , at (or below ) 25°C base-plate temperature *.....	7.2 W
Input continuous wave power, P <sub>IN</sub> .....	27 dBm
Operating Channel temperature, T <sub>CH</sub> **.....	150°C
Mounting temperature (30 sec.), T <sub>M</sub> .....	320°C
Storage temperature range, T <sub>STG</sub> .....	-65 to 150°C

**Ratings over operating channel temperature range, TCH (unless otherwise noted).**

Stresses beyond those listed under "Absolute Maximum Ratings" may cause permanent damage to the device. These are stress ratings only, and functional operation of the device at these or any other conditions beyond those indicated under "RF Characteristics" is not implied. Exposure to absolute maximum rated conditions for extended periods may affect device reliability.

\* For operation above 25°C base-plate temperature, derate linearly at the rate of 15.2 mW/°C.

\*\* Operating channel temperature directly affects the device MTTF. For maximum life, it is recommended that channel temperature be maintained at the lowest possible level. These ratings apply to each individual FET.

### TYPICAL S-PARAMETERS

Frequency (GHz)	S <sub>11</sub>		S <sub>21</sub>		S <sub>12</sub>		S <sub>22</sub>		GAIN (dB)
	MAG	ANG(°)	MAG	ANG(°)	MAG	ANG(°)	MAG	ANG(°)	
0.5	0.62	-67	2.156	154	0.001	42	0.36	-170	6.7
1.0	0.40	-103	2.092	143	0.001	65	0.35	171	6.4
1.5	0.30	-126	2.110	128	0.002	81	0.34	159	6.5
2.0	0.24	-146	2.132	113	0.003	80	0.33	150	6.6
2.5	0.21	-163	2.156	96	0.004	75	0.31	140	6.7
3.0	0.19	-180	2.181	80	0.005	66	0.29	133	6.8
3.5	0.16	166	2.213	63	0.006	56	0.27	126	6.9
4.0	0.14	151	2.241	47	0.007	46	0.24	120	7.0
4.5	0.12	138	2.294	30	0.008	32	0.22	116	7.2
5.0	0.09	128	2.338	12	0.009	18	0.19	115	7.4
5.5	0.06	125	2.374	-6	0.009	3	0.17	115	7.5
6.0	0.04	149	2.408	-24	0.009	-14	0.15	118	7.6
6.5	0.05	-178	2.431	-42	0.009	-27	0.15	122	7.7
7.0	0.09	-172	2.459	-61	0.009	-47	0.15	124	7.8
7.5	0.14	178	2.471	-79	0.008	-66	0.15	126	7.9
8.0	0.18	165	2.458	-98	0.008	-83	0.16	125	7.8
8.5	0.22	151	2.444	-117	0.008	-100	0.16	123	7.8
9.0	0.25	136	2.432	-135	0.009	-117	0.16	120	7.7
9.5	0.27	122	2.430	-153	0.010	-134	0.16	115	7.7
10.0	0.29	107	2.451	-172	0.011	-150	0.14	109	7.8
10.5	0.29	93	2.465	170	0.012	-165	0.13	104	7.8
11.0	0.27	81	2.470	151	0.013	176	0.11	97	7.9
11.5	0.25	69	2.492	132	0.014	155	0.08	98	7.9
12.0	0.20	59	2.532	111	0.014	133	0.07	115	8.1
12.5	0.16	57	2.521	90	0.012	107	0.08	134	8.0
13.0	0.13	64	2.471	70	0.007	89	0.09	133	7.9
13.5	0.12	74	2.446	51	0.004	89	0.10	123	7.8
14.0	0.14	80	2.447	31	0.003	133	0.09	114	7.8
14.5	0.17	83	2.457	10	0.006	134	0.08	108	7.8
15.0	0.19	71	2.507	-11	0.007	110	0.07	107	8.0
15.5	0.22	56	2.557	-34	0.007	80	0.05	124	8.2
16.0	0.21	38	2.572	-57	0.007	40	0.07	150	8.2
16.5	0.19	18	2.563	-80	0.005	1	0.11	153	8.2
17.0	0.14	-6	2.574	-104	0.006	-33	0.15	147	8.2
17.5	0.09	-26	2.562	-129	0.009	-75	0.18	137	8.2
18.0	0.06	-37	2.563	-154	0.012	-114	0.19	122	8.2
19.0	0.06	-42	2.561	151	0.015	179	0.14	93	8.2
19.5	0.08	-81	2.501	122	0.015	144	0.06	102	8.0
20.0	0.05	-103	2.430	94	0.015	108	0.10	-175	7.7

$$V_D = 8 \text{ V}, V_{CTRL} = 1 \text{ V}, I_D = 50\% I_{DSS}, T_A = 25^\circ\text{C},$$

The reference planes for S-parameter data include bond wires as specified in the "Recommended Assembly Diagram." The S-parameters are also available on floppy disk and the world wide web.

**RF CHARACTERISTICS**

PARAMETER		TEST CONDITIONS	TYP	UNIT
$G_p$	Small-signal power gain	$f = 2$ to 20 GHz	8	dB
$P_{1dB}$	Output power at 1-dB gain compression	$f = 2$ to 14 GHz	26	dBm
		$f = 14$ to 18 GHz	25	
$\Delta G_p$	Gain flatness	$f = 2$ to 20 GHz	$\pm 1$	dB
SWR(in)	Input standing wave ratio	$f = 2$ GHz	1.6:1	-
		$f = 9$ GHz	1.7:1	-
		$f = 18$ GHz	1.1:1	-
SWR(out)	Output standing wave ratio	$f = 2$ GHz	2.0:1	-
		$f = 9$ GHz	1.4:1	-
		$f = 18$ GHz	1.5:1	-
$IP_3$	Output third-order intercept point	$f = 2$ GHz	38	dBm
		$f = 9$ GHz	41	
		$f = 18$ GHz	38	

$V_D = 8\text{ V}, V_{CNTR} = 1\text{ V}, I_D = 50\% I_{DSS}, T_A = 25^\circ\text{C},$

**DC CHARACTERISTICS**

PARAMETER		TEST CONDITIONS	MIN	MAX	UNIT
$I_{DSS}$	Total zero-gate-voltage drain current at saturation	$V_{DS} = 0.5\text{ V to }3.5\text{ V}, V_{GS} = 0\text{ V}$	630	1170	mA

$T_A = 25^\circ\text{C}$

$V_{DS}$  for  $I_{DSS}$  is the drain voltage between 0.5 V and 3.5 V at which drain current is highest at DC Autoprobe.

**THERMAL INFORMATION**

PARAMETER	TEST CONDITION	NOM	UNIT
$R_{\theta JC}$ Thermal resistance (channel to back side)	$V_D = 8\text{ V}, I_D = 50\% I_{DSS}, V_{CTRL} = 1\text{ V}$	18.7	$^\circ\text{C/W}$

**EQUIVALENT SCHEMATIC**

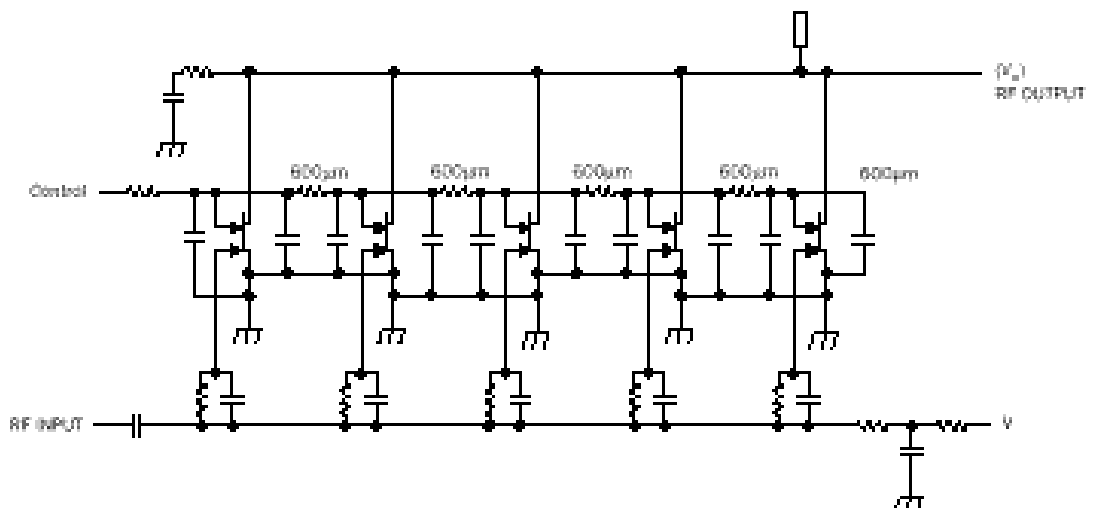

**RECOMMENDED TEST CONFIGURATION**

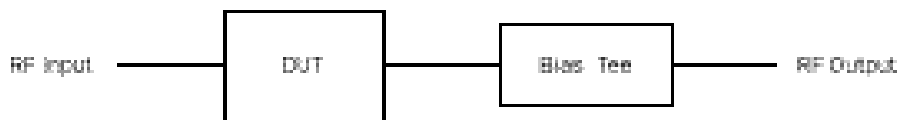

**RECOMMENDED ASSEMBLY DIAGRAM**

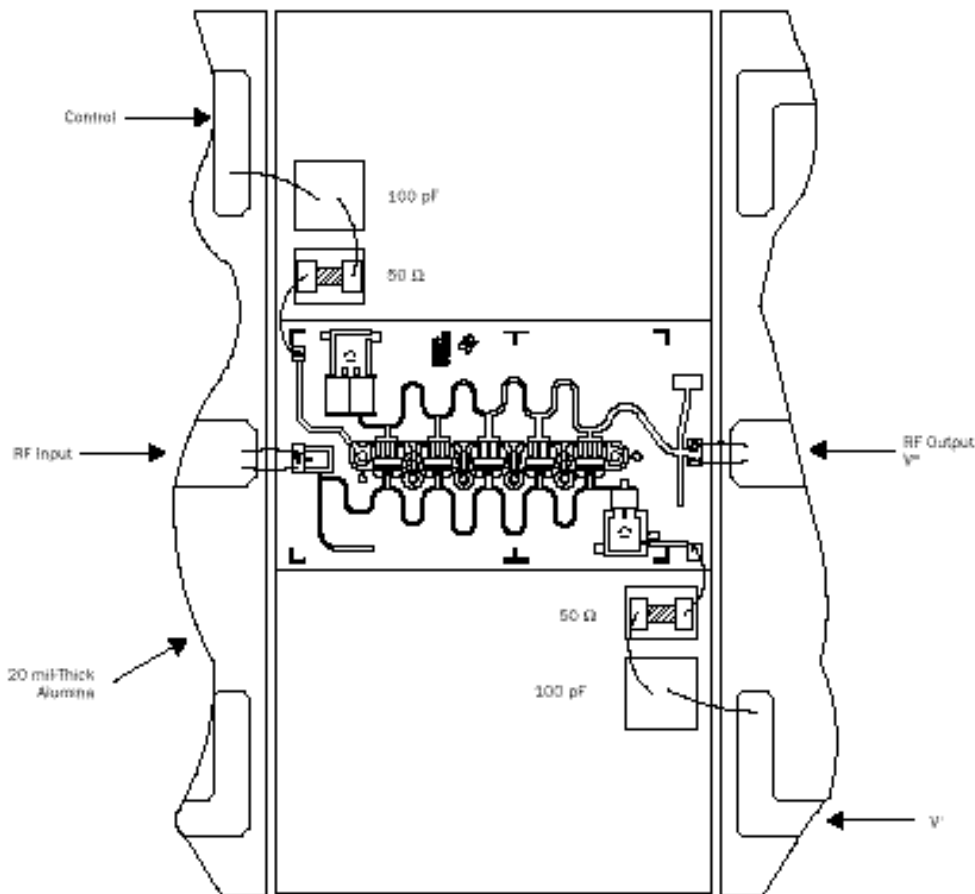

RF connections: Bond using two 1.0-mil diameter, 20 to 25-mil-length gold bond wires at both RF Input and RF Output.

DC blocks required at RF Output port.

Close placement of external components is essential to stability.

Refer to TriQuint's Recommended Assembly Instructions for GaAs Products.

**MECHANICAL  
DRAWING**

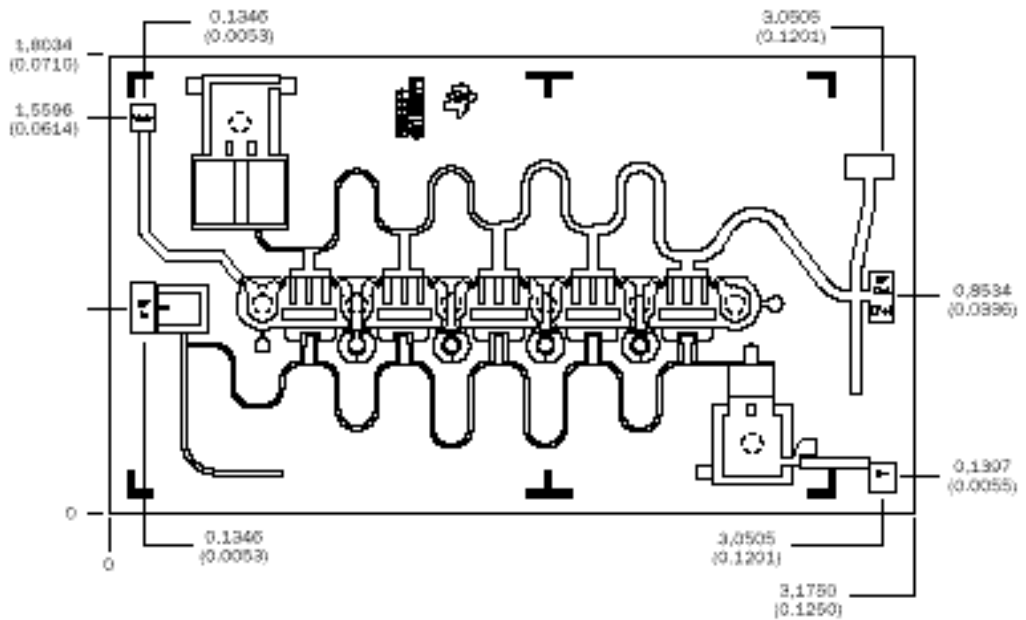

Units: millimeters (inches)  
 Thickness: 0,1524 (0.006) (reference only)  
 Chip edge to bond pad dimensions are shown to center of bond pad.  
 Chip size  $\pm$  0,0508 (0.002)

Bond pad RF In:	0,0965 x 0,1981 (0.0038 x 0.0078)
Bond pad RF Out (V*):	0,0965 x 0,1981 (0.0038 x 0.0078)
Bond pad V <sup>-</sup> :	0,0965 x 0,1219 (0.0038 x 0.0048)
Bond pad control:	0,0965 x 0,0965 (0.0038 x 0.0038)

**GaAs MMIC devices are susceptible to damage from Electrostatic Discharge. Proper precautions should be observed during handling, assembly and test.**