

# CEP7060R/CEB7060R



March 1998

4

## N-Channel Enhancement Mode Field Effect Transistor

### FEATURES

- 60V , 75A ,  $R_{DS(ON)}=13m\Omega$  @  $V_{GS}=10V$ .
- Super high dense cell design for extremely low  $R_{DS(ON)}$ .
- High power and current handling capability.
- TO-220 & TO-263 package.

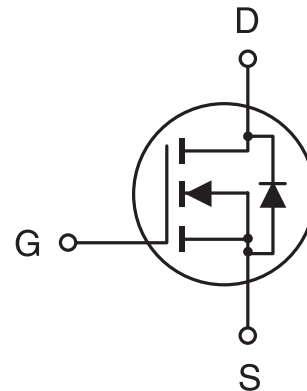

### ABSOLUTE MAXIMUM RATINGS ( $T_c=25^\circ C$ unless otherwise noted)

Parameter	Symbol	Limit	Unit
Drain-Source Voltage	$V_{DS}$	60	V
Gate-Source Voltage	$V_{GS}$	$\pm 20$	V
Drain Current-Continuous -Pulsed	$I_D$	75	A
	$I_{DM}$	225	A
Drain-Source Diode Forward Current	$I_S$	75	A
Maximum Power Dissipation @ $T_c=25^\circ C$ Derate above $25^\circ C$	$P_D$	150	W
		1	W/ $^\circ C$
Operating and Storage Temperature Range	$T_J, T_{STG}$	-65 to 175	$^\circ C$

### THERMAL CHARACTERISTICS

Thermal Resistance, Junction-to-Case	$R_{\theta JC}$	1	$^\circ C/W$
Thermal Resistance, Junction-to-Ambient	$R_{\theta JA}$	62.5	$^\circ C/W$

# CEP7060R/CEB7060R

## ELECTRICAL CHARACTERISTICS (Tc=25°C unless otherwise noted)

4

Parameter	Symbol	Condition	Min	Typ	Max	Unit
<b>DRAIN-SOURCE AVALANCHE RATING<sup>a</sup></b>						
Single Pulse Drain-Source Avalanche Energy	EAS	V <sub>DD</sub> =25V, I <sub>D</sub> =150A		430		mJ
Maximum Drain-Source Avalanche Current	I <sub>AS</sub>	L=25μH		150		A
<b>OFF CHARACTERISTICS</b>						
Drain-Source Breakdown Voltage	BV <sub>DSS</sub>	V <sub>GS</sub> =0V, I <sub>D</sub> =250μA	60			V
Zero Gate Voltage Drain Current	I <sub>DSS</sub>	V <sub>DS</sub> =60V, V <sub>GS</sub> =0V			25	μA
Gate-Body Leakage	I <sub>GSS</sub>	V <sub>GS</sub> =±20V, V <sub>DS</sub> =0V			±100	nA
<b>ON CHARACTERISTICS<sup>a</sup></b>						
Gate Threshold Voltage	V <sub>GS(th)</sub>	V <sub>DS</sub> =V <sub>GS</sub> , I <sub>D</sub> =250μA	2	2.8	4	V
Drain-Source On-State Resistance	R <sub>DS(ON)</sub>	V <sub>GS</sub> =10V, I <sub>D</sub> =40A		11	13	mΩ
On-State Drain Current	I <sub>D(ON)</sub>	V <sub>GS</sub> =10V, V <sub>DS</sub> =10V	60			A
Forward Transconductance	g <sub>FS</sub>	V <sub>DS</sub> =10V, I <sub>D</sub> =37.5A		39		S
<b>SWITCHING CHARACTERISTICS<sup>b</sup></b>						
Turn-On Delay Time	t <sub>D(ON)</sub>	V <sub>DD</sub> =30V, I <sub>D</sub> =75A, V <sub>GS</sub> =10V		20	30	ns
Rise Time	t <sub>r</sub>			250	400	ns
Turn-Off Delay Time	t <sub>D(OFF)</sub>			45	80	ns
Fall Time	t <sub>f</sub>			130	200	ns
Total Gate Charge	Q <sub>g</sub>	V <sub>DS</sub> =48V, I <sub>D</sub> =75A, V <sub>GS</sub> =10V		61	115	nC
Gate-Source Charge	Q <sub>gs</sub>			15		nC
Gate-Drain Charge	Q <sub>gd</sub>			18		nC

# CEP7060R/CEB7060R

## ELECTRICAL CHARACTERISTICS ( $T_c=25^\circ\text{C}$ unless otherwise noted)

4

Parameter	Symbol	Condition	Min	Typ	Max	Unit
<b>DYNAMIC CHARACTERISTICS<sup>b</sup></b>						
Input Capacitance	$C_{iss}$	$V_{DS}=25\text{V}, V_{GS}=0\text{V}$ $f=1.0\text{MHz}$		2810	3600	pF
Output Capacitance	$C_{oss}$			1075	1600	pF
Reverse Transfer Capacitance	$C_{rss}$			360	800	pF
<b>DRAIN-SOURCE DIODE CHARACTERISTICS<sup>a</sup></b>						
Diode Forward Voltage	$V_{SD}$	$V_{GS}=0\text{V}, I_S=37.5\text{A}$		0.9	1.3	V

### Notes

a. Pulse Test: Pulse Width  $\leq 300 \mu\text{s}$ , Duty Cycle  $\leq 2\%$ .

b. Guaranteed by design, not subject to production testing.

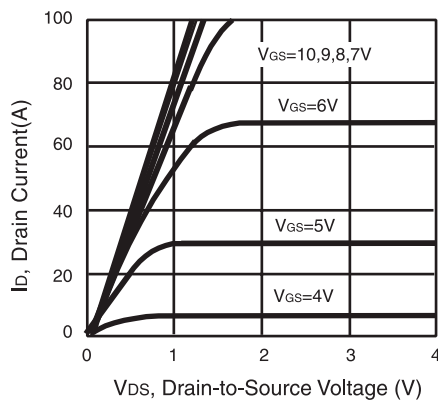

Figure 1. Output Characteristics

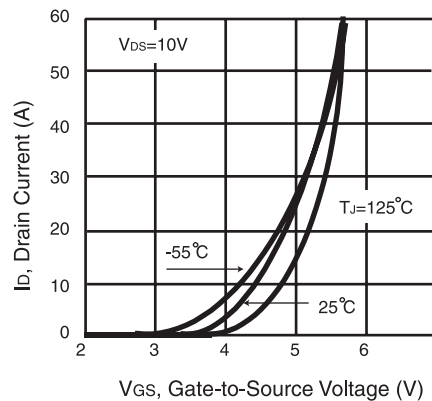

Figure 2. Transfer Characteristics

# CEP7060R/CEB7060R

4

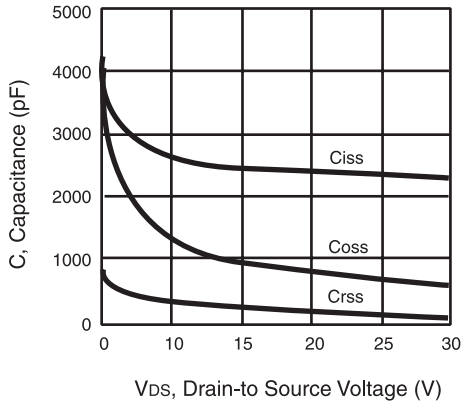

Figure 3. Capacitance

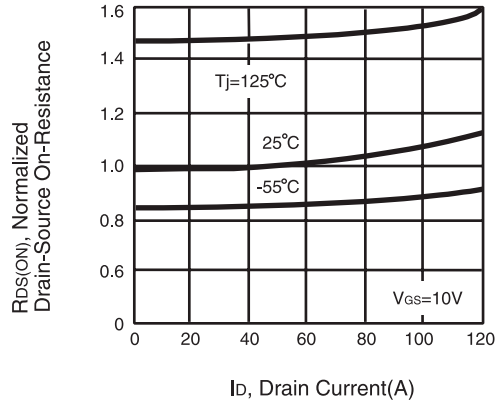

Figure 4. On-Resistance Variation with Drain Current and Temperature

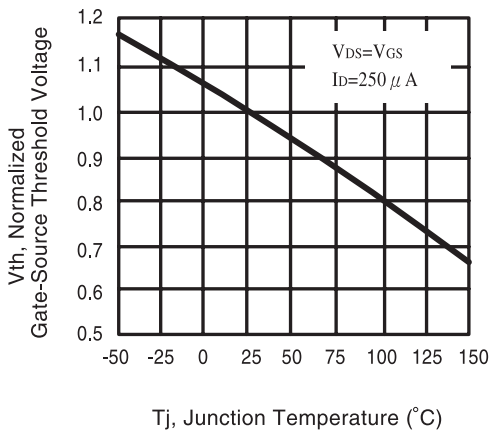

Figure 5. Gate Threshold Variation with Temperature

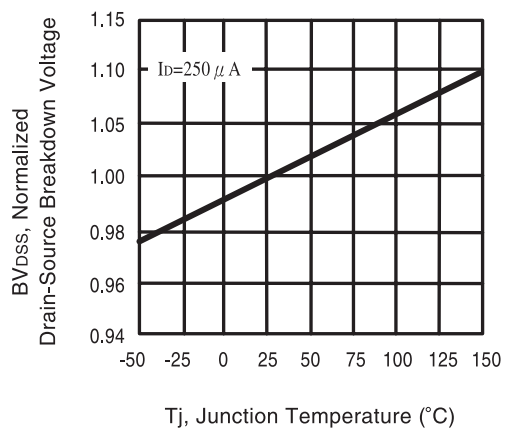

Figure 6. Breakdown Voltage Variation with Temperature

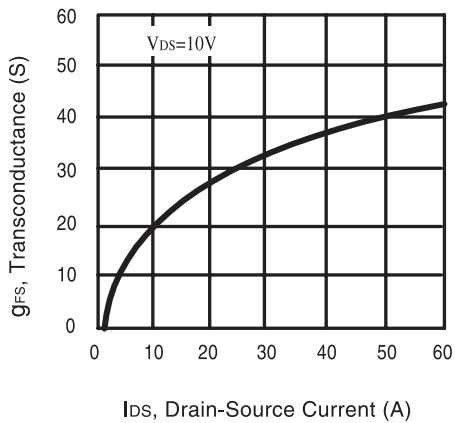

Figure 7. Transconductance Variation with Drain Current

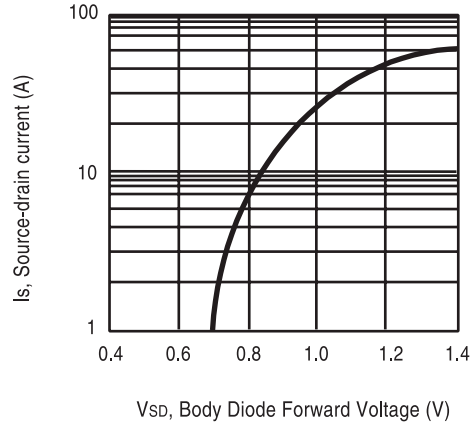

Figure 8. Body Diode Forward Voltage Variation with Source Current

# CEP7060R/CEB7060R

4

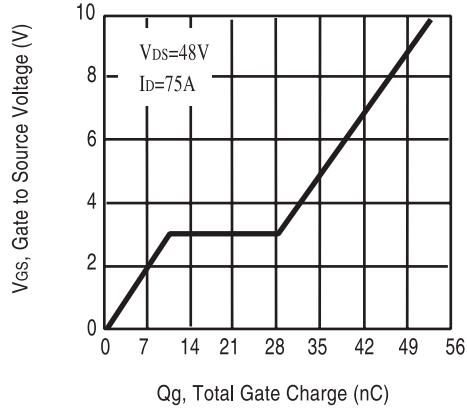

Figure 9. Gate Charge

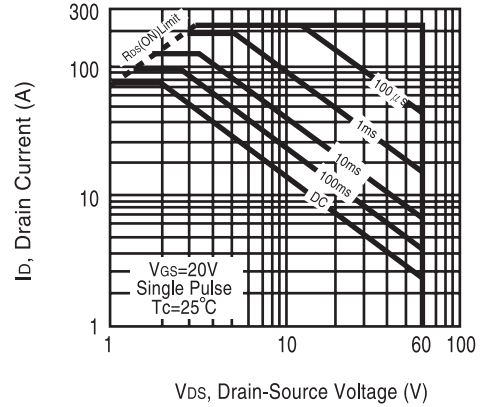

Figure 10. Maximum Safe Operating Area

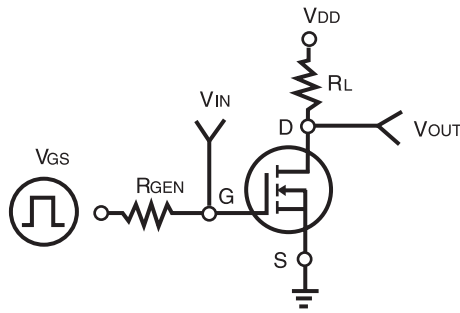

Figure 11. Switching Test Circuit

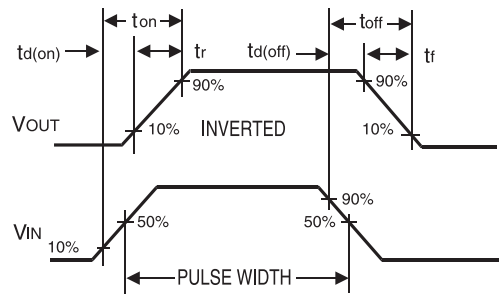

Figure 12. Switching Waveforms

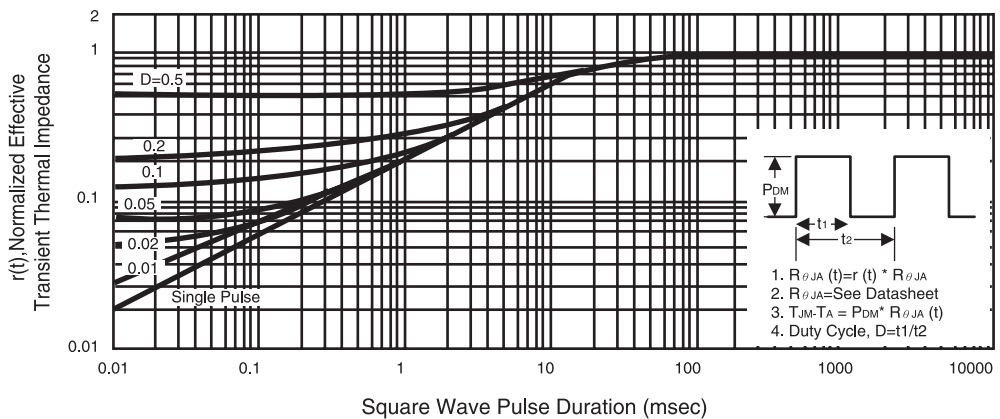

Figure 13. Normalized Thermal Transient Impedance Curve