



DESCRIPTION

The AD6C212 is a bi-directional, single-pole, single-throw, normally closed multipurpose solid-state relay. It is designed to replace electromechanical relays in general purpose switching applications. The relay consists of an integrated circuit that drives two rugged source-to-source depletion type DMOS transistors - optically coupled to a light emitting diode. The output MOS transistors are protected with free-wheeling diodes that can handle up to 1.5A of inrush current, making the relay ideal for switching lamps and highly inductive loads.

FEATURES

- High input-to-output isolation
- Low input control power consumption
- 140mA maximum continuous load current
- 25 ohms maximum on-resistance
- Long life/high reliability

APPLICATIONS

- Telecom switching
- Tip/Ring control
- PCMCIA modules
- Multiplexers
- Meter reading systems
- Data acquisition
- Medical equipment
- Battery monitoring
- Home/Safety security systems

OPTIONS/SUFFIXES

- -H High Output Isolation
- -S Surface Mount Option
- -TR Tape and Reel

MAXIMUM RATINGS

| PARAMETER | UNIT | MIN | TYP | MAX |
|-------------------------------|------|-----|-----|-----|
| Storage Temperature | °C | -55 | | 125 |
| Operating Temperature | °C | -40 | | 85 |
| Continuous Input Current | mA | | | 40 |
| Transient Input Current | mA | | | 400 |
| Reverse Input Control Voltage | V | 6 | | |
| Output Power Dissipation | mW | | | 500 |

SCHEMATIC DIAGRAM

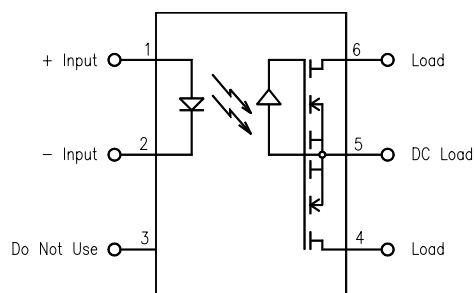

APPROVALS

- BAPT CERTIFICATE #607836:
BS EN 60950, BS EN 41003, BS EN 60065
- CSA CERTIFICATE #LR111581-1
- UL FILE #E90096

ELECTRICAL CHARACTERISTICS - 25°

| PARAMETER | UNIT | MIN | TYP | MAX | TEST CONDITIONS |
|-------------------------------|---------|------|------|-----|----------------------|
| INPUT SPECIFICATIONS | | | | | |
| LED Forward Voltage | V | | 1.2 | 1.5 | If = 10mA |
| LED Reverse Voltage | V | 6 | 12 | | Ir = 10uA |
| Turn-On Current | m A | | 0.5 | | Io = 140mA |
| Turn-Off Current | m A | | 2.5 | 5 | |
| OUTPUT SPECIFICATIONS | | | | | |
| Blocking Voltage | V | 400 | | | Io = 10uA |
| Continuous Load Current | m A | | | 140 | If = 0mA |
| On-Resistance | Ω | | 20 | 25 | Io = 140mA |
| Leakage Current | μ A | | 0.2 | 10 | Vo = 400V |
| Output Capacitance | p F | | 25 | 50 | Vo = 25V, f = 1.0MHz |
| Offset Voltage | m V | | | 0.2 | If = 0mA |
| COUPLED SPECIFICATIONS | | | | | |
| Isolation Voltage | V | 2500 | | | T = 1 minute |
| -H Suffix | V | 3750 | | | T = 1 minute |
| Turn-On Time | m s | | 0.1 | 0.5 | If = 0mA, Io = 140mA |
| Turn-Off Time | m s | | 0.5 | 1 | If = 5mA, Io = 140mA |
| Isolation Resistance | G Ω | 100 | | | |
| Coupled Capacitance | p F | | 3 | | |
| Contact Transient Ratio | V / μ s | 2000 | 7000 | | dV = 50V |



PERFORMANCE DATA

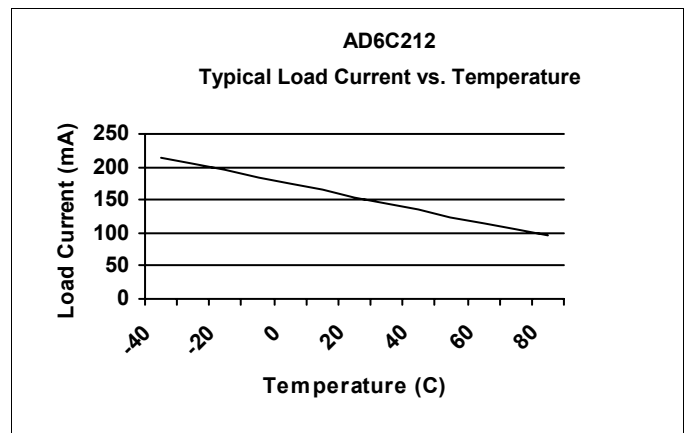
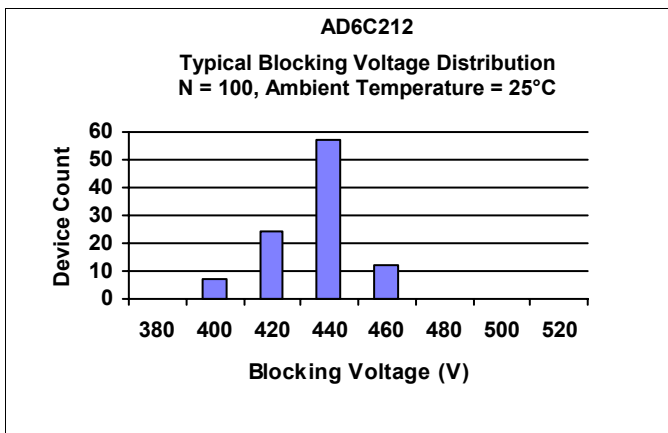
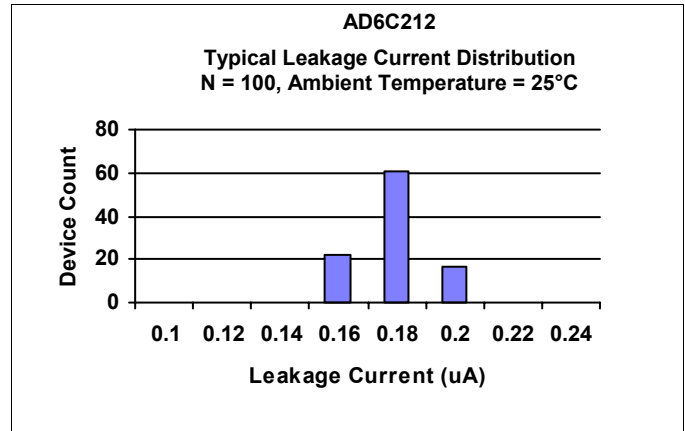
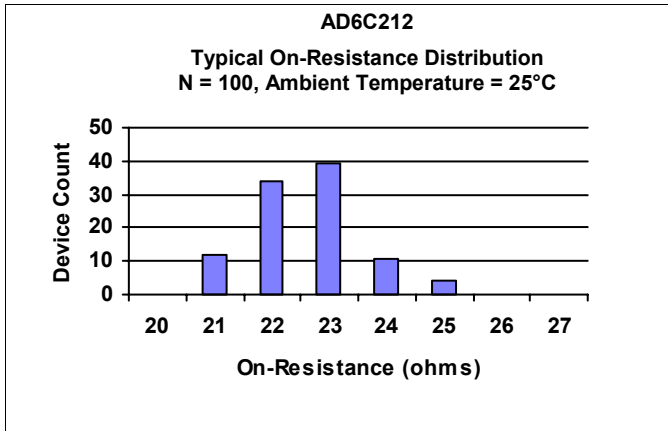
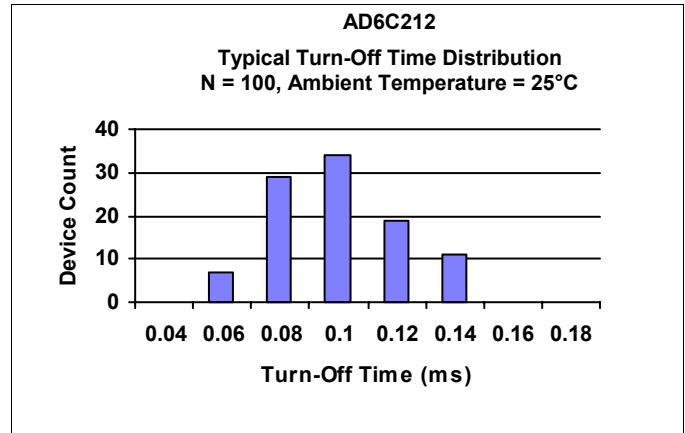
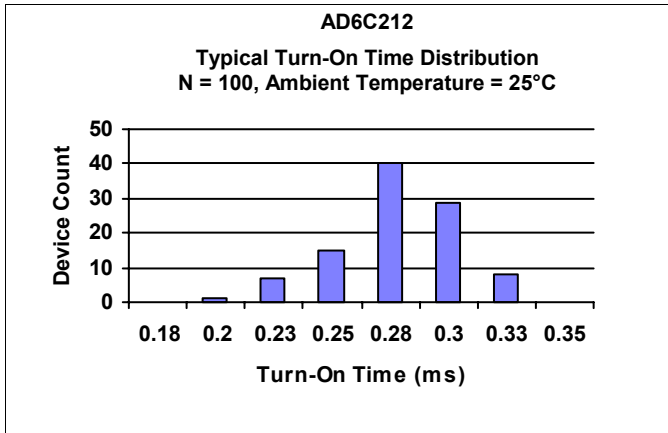



MECHANICAL DIMENSIONS

6 PIN DUAL IN-LINE PACKAGE

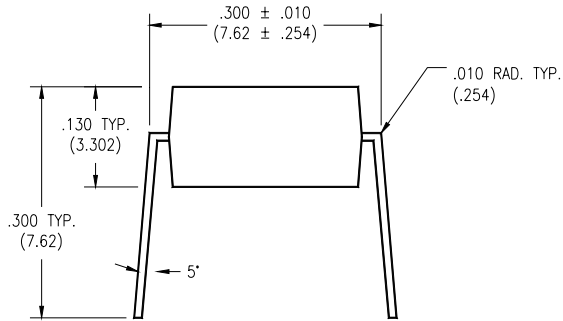

END VIEW

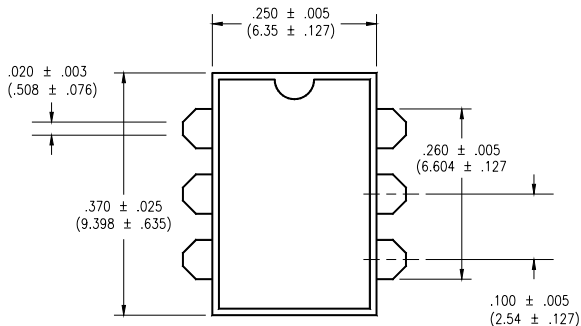

TOP VIEW

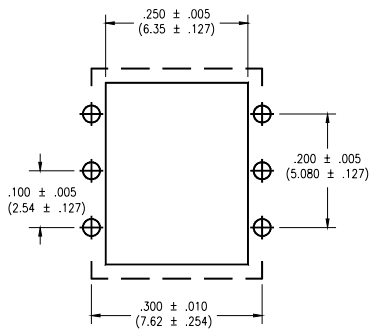

**BOTTOM VIEW/
BOARD PATTERN**

6 PIN SURFACE MOUNT DEVICE

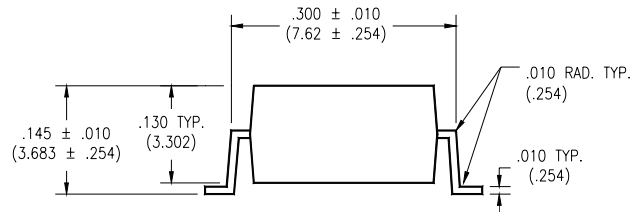

END VIEW

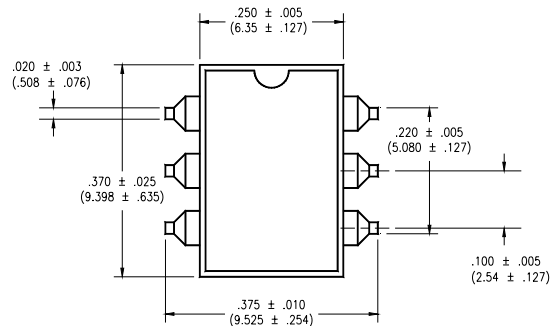

TOP VIEW

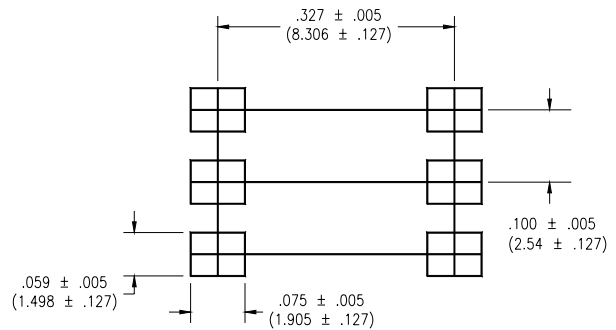

**BOTTOM VIEW/
BOARD PATTERN**