

TRIPLE DIFFUSED PLANER TYPE
HIGH VOLTAGE, HIGH SPEED SWITCHING

Features

- High voltage, High speed switching
- Low saturation voltage
- High reliability

Applications

- Switching regulators
- DC-DC convertor
- Solid state relay
- General purpose power amplifiers

Outline Drawings

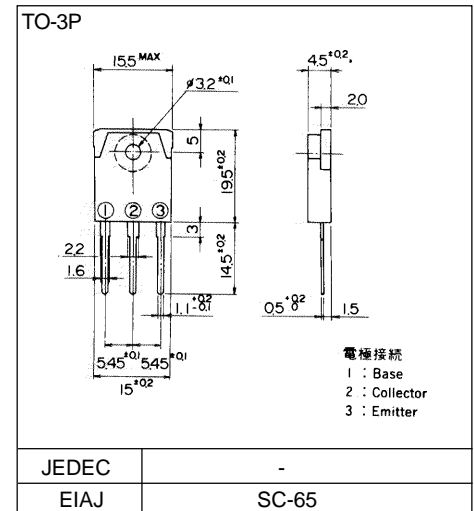

Maximum ratings and characteristics

Absolute maximum ratings (T_c=25°C unless otherwise specified)

Item	Symbol	Ratings	Unit
Collector-Base voltage	V _{CB0}	500	V
Collector-Emitter voltage	V _{CE0}	400	V
Emitter-Base voltage	V _{EB0}	10	V
Collector current	I _C	15	A
Base current	I _B	5	A
Collector power dissipation	P _C	80	W
Operating junction temperature	T _j	+150	°C
Storage temperature	T _{stg}	-55 to +150	°C

Electrical characteristics (T_c =25°C unless otherwise specified)

Item	Symbol	Test Conditions	Min.	Typ.	Max.	Units
Collector-Base voltage	V _{CB0}	I _{CBO} = 1mA	500			V
Collector-Emitter voltage	V _{CE0}	I _{CEO} = 0.2A	400			V
Emitter-Base voltage	V _{EB0}	I _{EBO} = 1mA	10			V
Collector-Base leakage current	I _{CBO}	V _{CB0} = 450V			0.1	mA
Emitter-Base leakage current	I _{EBO}	V _{EB0} = 10V			0.1	mA
D.C. current gain	h _{FE}	I _C = 2A, V _{CE} = 5V	25		65	
Collector-Emitter saturation voltage	V _{CE(Sat)}	I _C = 6A, I _B = 1200mA			0.8	V
Base-Emitter saturation voltage	V _{BE(Sat)}				1.2	V
*1 Switching time	t _{on}	I _C = 7.5A, I _{B1} = 750mA			1.0	μs
	t _{stg}	I _{B2} = -1500mA, R _L = 20 ohm			2.5	μs
	t _f	P _w = 20μs Duty=<2%			0.5	μs

Thermal characteristics

Item	Symbol	Test Conditions	Min.	Typ.	Max.	Units
Thermal resistance	R _{th(j-c)}	Junction to case			1.56	°C/W

Characteristics

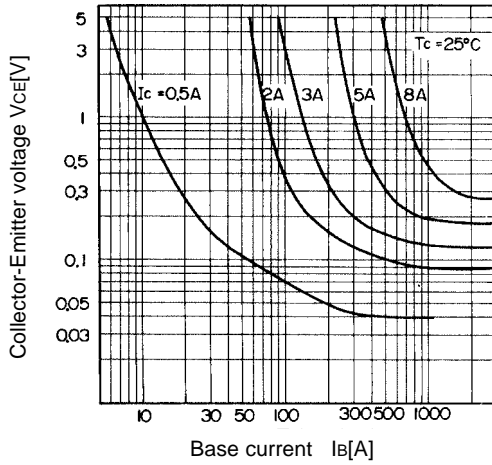

Collector Output Characteristics

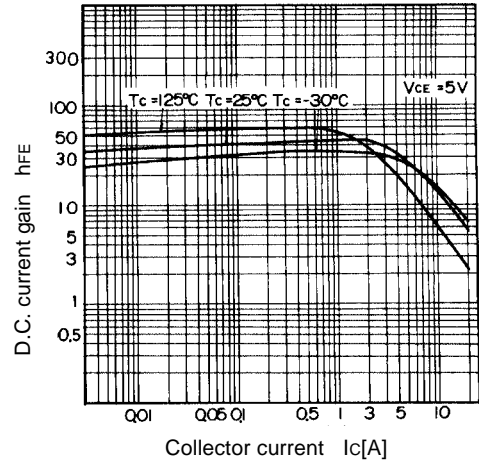

DC Current Gain

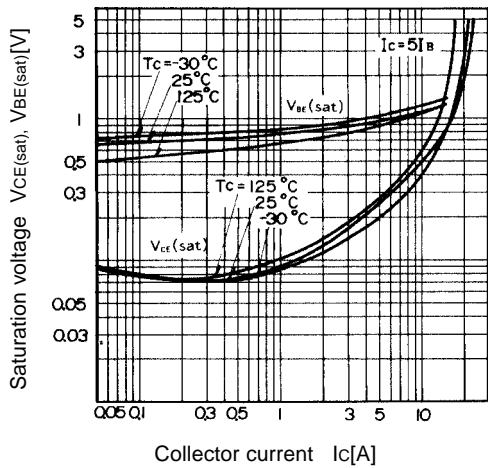

Base and Collector Saturation Voltage

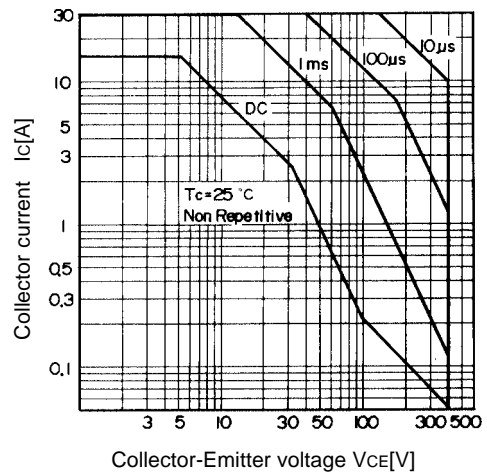

Safe Operating Area

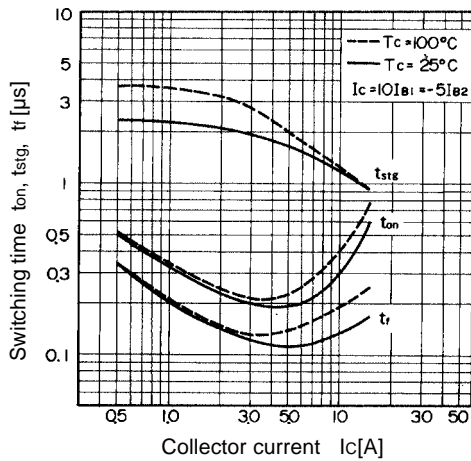

Switching Time

*1 Switching Time Test Circuit

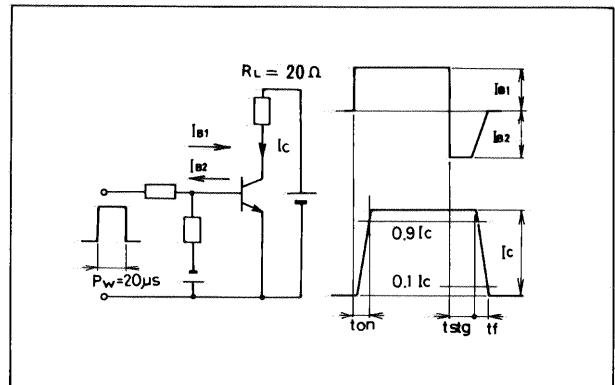

This datasheet has been download from:

www.datasheetcatalog.com

Datasheets for electronics components.