

Description

The SP6300 is specifically designed to satisfy the requirements for increased Integration and reliability in offline Quasi-resonant (ZVS: Zero Voltage Switching at switch turn-on) flyback converters. Quasi-resonant operation is achieved by means of a transformer demagnetization sensing input that triggers MOSFET's turn-on. Converter's power capability variations with the mains voltage are compensated by line voltage feedforward. At light load the device features a special function that automatically lowers the operating frequency still maintaining the operation as close to ZVS as possible. In addition to very low start-up and quiescent currents, this feature helps keep low the consumption from the mains at light load and be Blue Angel and Energy Star compliant.

Features

- Flyback Operation with Quasi-Resonant Soft Switching for Low Power Dissipation and EMI
- Temperature-Compensated Pulse-by-pulse Over-Current Protection
- Latched Over-Voltage and Thermal Protection
- Under-Voltage Lockout with Hysteresis
- Active Low-Pass Filter for Enhanced Light-Load Stability
- Regulated Soft Gate Drive

Applications

- TV/MONITOR SMPS
- AC-DC ADAPTERS/CHARGERS
- DIGITAL CONSUMER
- PRINTERS, FAX MACHINES, PHOTOCOPIERS AND SCANNERS

Ordering Information

Type NO.	Marking	Package Code
SP6300P	SP6300	SOP-8

Outline Dimensions

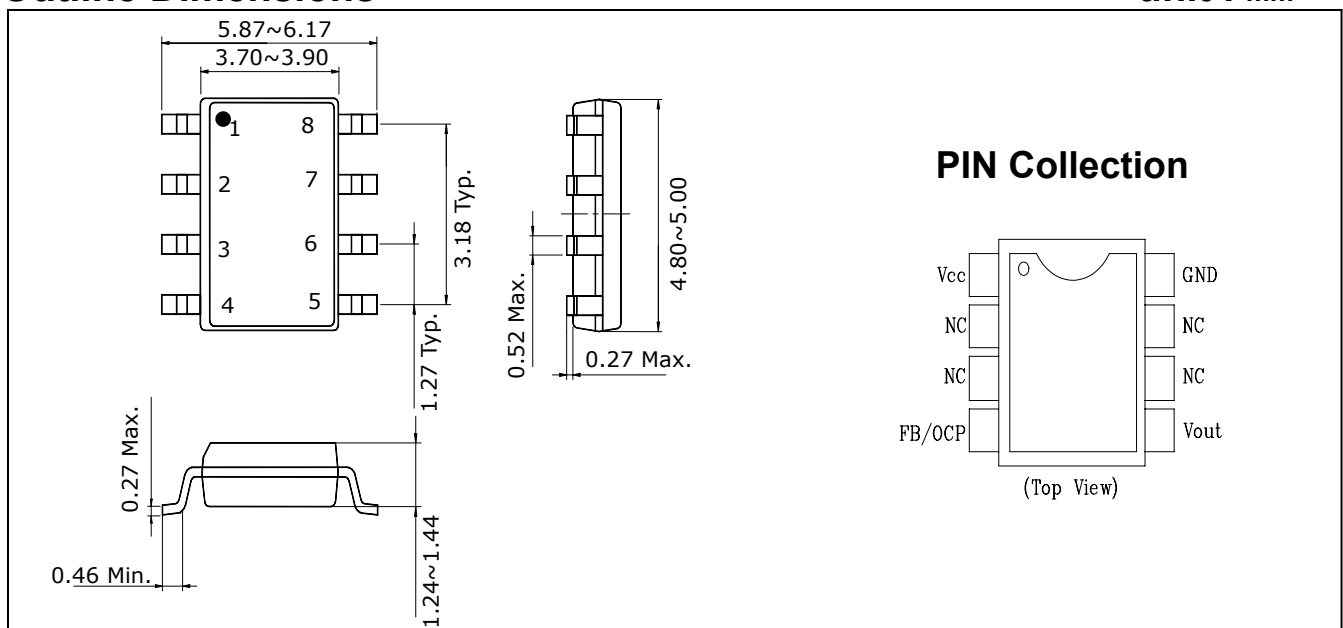
unit : mm

Internal Block Diagram

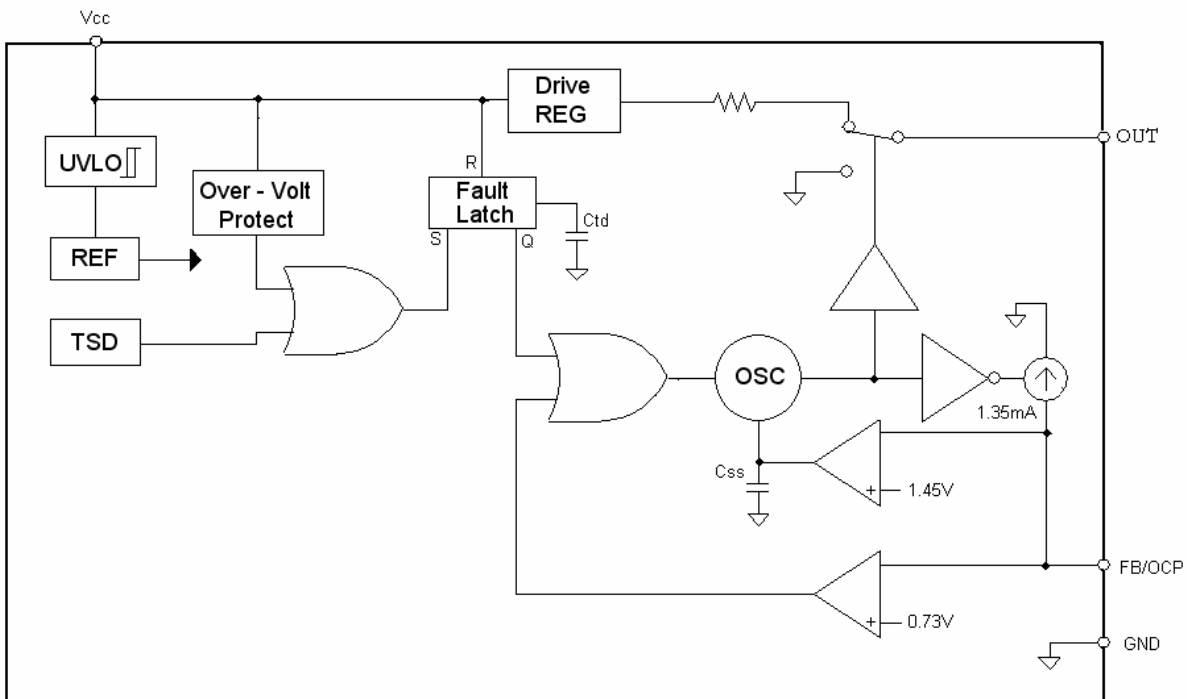

Pin Function

Pin Number	Pin Name	Pin Function Description
1	Vcc	Supply voltage of both the signal part of the IC and the gate driver
2, 3	NC	No Connection
4	FB/OCF	Voltage mode control feedback signal, and over current detection
5	OUT	Gate driver output. The totem-pole output driver to drive the power MOSFET.
6, 7	NC	No Connection
8	GND	Ground. Current return for both the signal part of the IC and the gate driver.

Absolute maximum ratings

Characteristic	Symbol	Ratings	Unit
Supply Voltage	V_{CC}	20	V
Peak Drive Output Current	I_{OH} / I_{OL}	+400 / -100	mA
FB/OCF Voltage Range	$V_{FB/OCF}$	-0.3 ~ +6	V
Power Dissipation	P_D	0.5	W
Operating Temperature Range	T_{opr}	-25 ~ +125	°C
Storage Temperature Range	T_{stg}	-55 ~ +150	°C

Electrical Characteristics

($V_{CC} = 11V$, $-25^{\circ}C \leq T_a \leq +125^{\circ}C$; Unless otherwise specified)

Characteristic	Symbol	Test Conditions	Min	Typ	Max	Unit
SUPPLY VOLTAGE & CURRENT SECTION						
Start Threshold Voltage	$V_{TH(ST)}$	Vcc Increasing	8.5	9.5	10.5	V
Stop Threshold Voltage	$V_{TH(SP)}$	Vcc Decreasing after Turn on Start Threshold Voltage	7.2	8	8.8	V
Start up Supply Current	I_{ST}	$V_{CC} = V_{TH(ST)} - 0.1V$	-	-	100	μA
Operating Supply Current	I_{CC}	$V_{FB} = 1V$	-	3	7	mA
Dynamic Operating Supply Current (Note1)	I_{DCC}	$C_o = 1.0nF$	-	4	10	mA
PROTECTION SECTION						
Over Voltage Threshold	V_{OVP}	Vcc Increasing until Shut down Output	15.3	17	18.7	V
Thermal Shutdown Activation Temperature	$T_j(TSD)$	-	-	140	-	$^{\circ}C$
Latch Release Voltage	V_{RE}	Vcc Decreasing until Latch Releasing	2.5	-	6.0	V
Latch Holding Current	$I_{CC(RE)}$	-	-	-	400	μA
FEEDBACK SECTION						
Feedback Threshold Voltage	V_{FB}	-	0.68	0.73	0.78	V
Css Synchronized Voltage	V_{SYNC}	-	1.30	1.45	1.60	V
Feedback Sink Current	I_{SINK}	$V_{FB} = 1V$	1.20	1.35	1.50	mA
MAXIMUM & MINIMUM OFF TIME SECTION						
Maximum Off Time	t_{MAX}	-	30	-	60	μs
Minimum Off Time (Note1)	t_{MIN}	-	-	-	1.5	μs
Minimum Input Pulse Width (Note1)	$t_{MIN(W)}$	-	-	-	1.0	μs
OUTPUT SECTION						
Output Voltage High	V_{OH}	$V_{FB} = 0V, I_{SOURCE} = 5mA$	9.5	10	10.5	V
Output Voltage Low	V_{OL}	$V_{FB} = 1V, I_{SINK} = 5mA$	-	10	50	mV
Output Sink Current	I_{GDSINK}	$V_o = 7V$	-	300	-	mA
Output Source Current	$I_{GDSOURCE}$	$V_o = 5V$	-	80	-	mA
Output Voltage Rising Time	t_r	$C_o = 1nF$	-	150	-	ns
Output Voltage Falling Time	t_f	$C_o = 1nF$	-	50	-	ns

Note 1 : Feedback is square wave, $V1 = 0V$, $V2 = 2V$, $T_d = 0$, $T_r = 1ns$, $T_f = 1ns$, $PW = 1\mu s$, $PER = 36\mu s$

Electrical Characteristic Curves

Fig. 1 I_{CC} vs. T_a

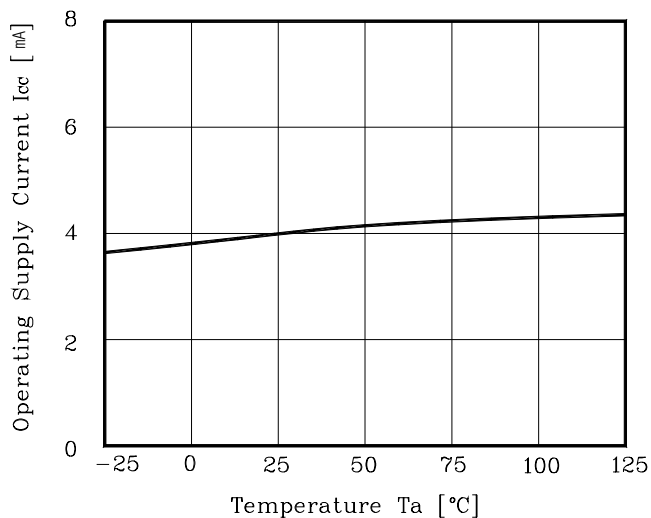

Fig. 2 $V_{TH(SP)}$ vs. T_a

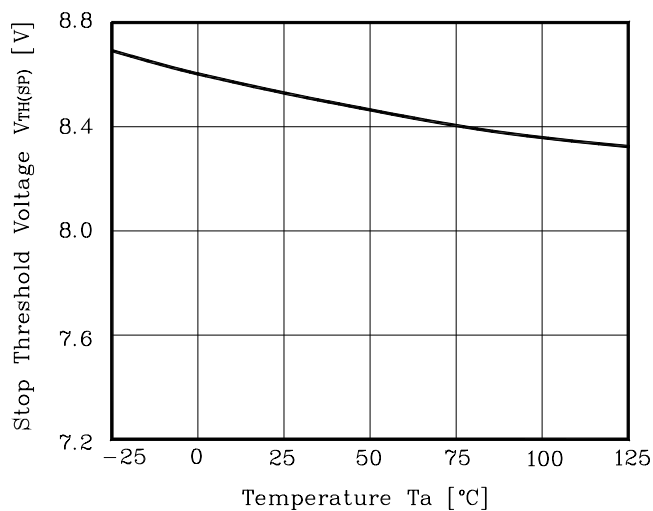

Fig. 3 I_{ST} vs. T_a

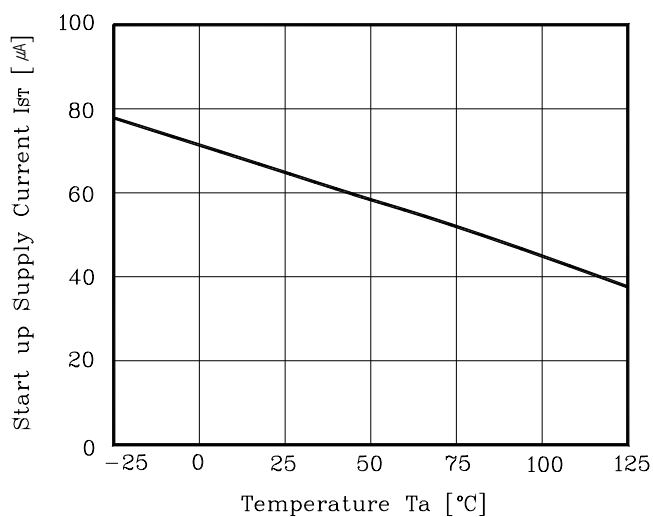

Fig. 4 V_{FB} vs. T_a

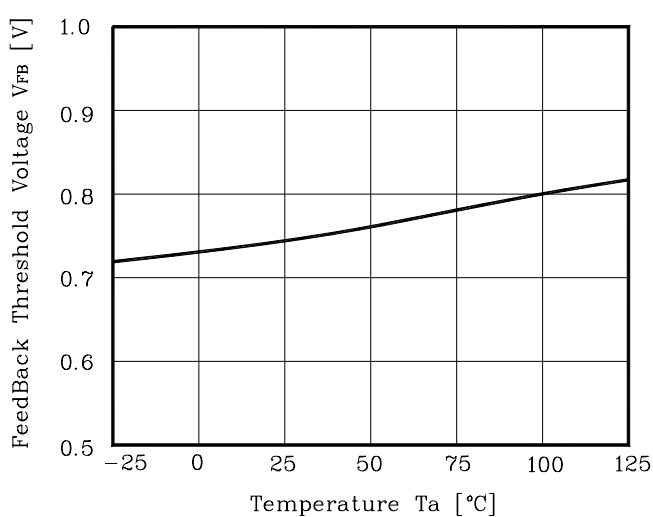

Fig. 5 $V_{TH(ST)}$ vs. T_a

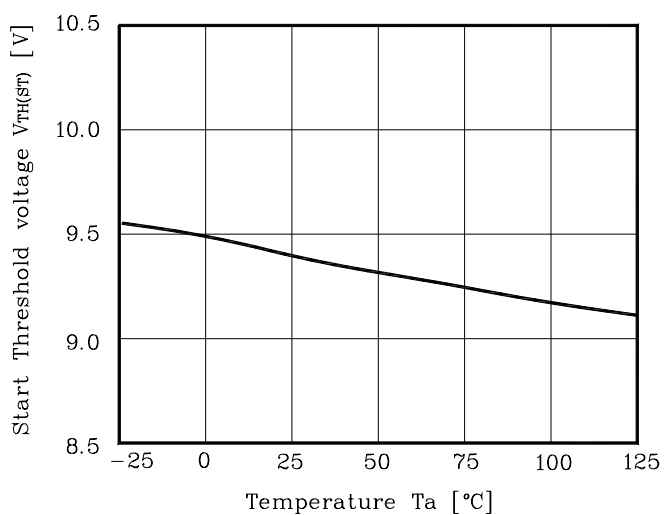
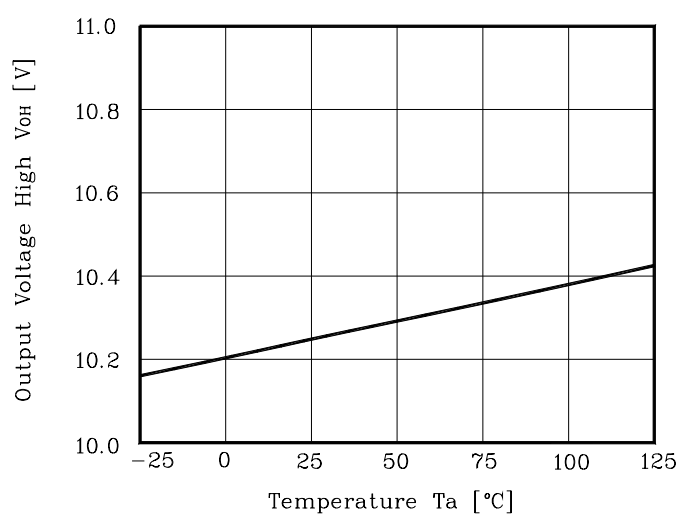

Fig. 6 V_{OH} vs. T_a



Electrical Characteristic Curves

Fig. 7 V_{OL} vs. T_a

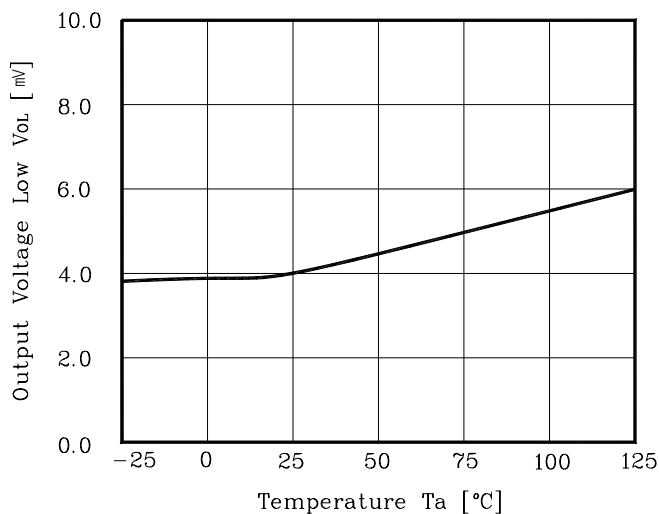

Fig. 8 V_{OUT} vs. I_{sink}

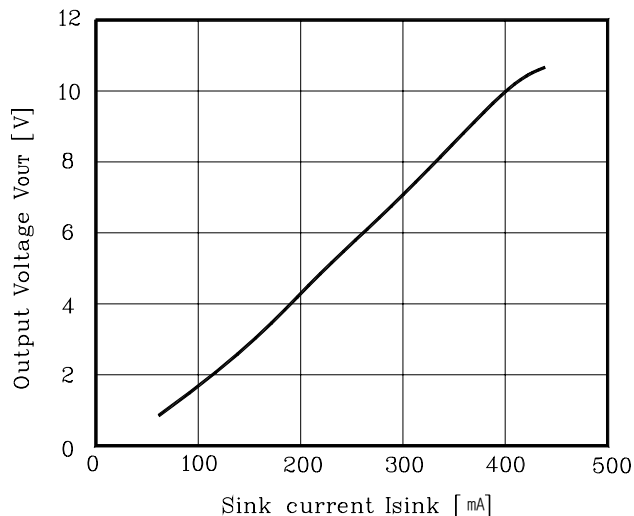
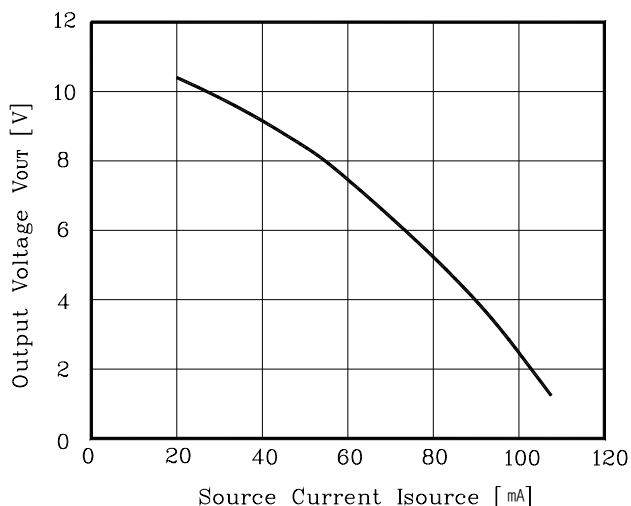

Fig. 9 V_{OUT} vs. I_{source}



The AUK Corp. products are intended for the use as components in general electronic equipment (Office and communication equipment, measuring equipment, home appliance, etc.).

Please make sure that you consult with us before you use these AUK Corp. products in equipments which require high quality and / or reliability, and in equipments which could have major impact to the welfare of human life(atomic energy control, airplane, spaceship, transportation, combustion control, all types of safety device, etc.). AUK Corp. cannot accept liability to any damage which may occur in case these AUK Corp. products were used in the mentioned equipments without prior consultation with AUK Corp..

Specifications mentioned in this publication are subject to change without notice.