



8ETH03  
8ETH03S  
8ETH03-1

## Ultrafast Rectifier

### Features

- Ultrafast Recovery Time
- Low Forward Voltage Drop
- Low Leakage Current
- 175°C Operating Junction Temperature

$t_{rr} = 35ns$
$I_{F(AV)} = 8Amp$
$V_R = 300V$

### Description/ Applications

International Rectifier's 300V series are the state of the art Ultrafast recovery rectifiers designed with optimized performance of forward voltage drop and Ultrafast recovery time.

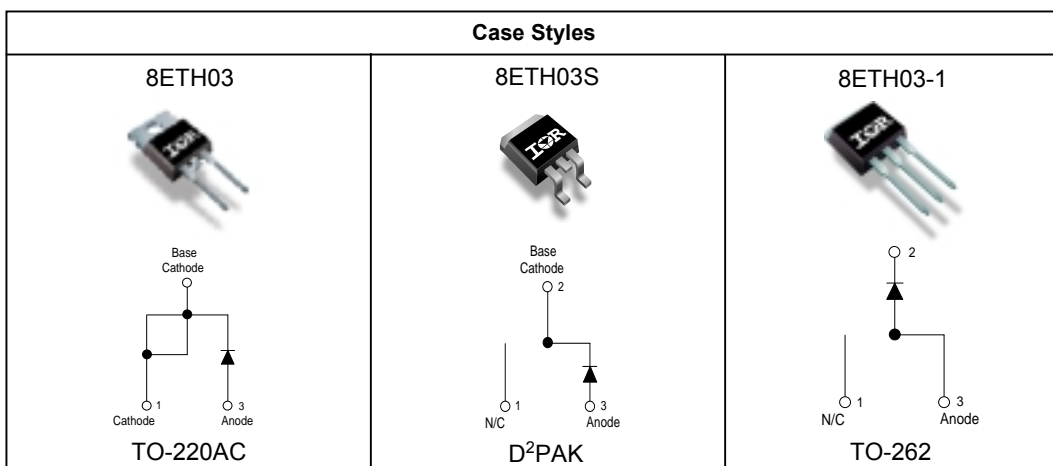
The planar structure and the platinum doped life time control guarantee the best overall performance, ruggedness and reliability characteristics.

These devices are intended for use in the output rectification stage of SMPS, UPS, DC-DC converters as well as freewheeling diodes in low voltage inverters and chopper motor drives.

Their extremely optimized stored charge and low recovery current minimize the switching losses and reduce over dissipation in the switching element and snubbers.

### Absolute Maximum Ratings

Parameters	Max	Units
$V_{RRM}$ Repetitive Peak Reverse Voltage	300	V
$I_{F(AV)}$ Average Rectified Forward Current @ $T_C = 155^\circ C$	8	A
$I_{FSM}$ Non Repetitive Peak Surge Current @ $T_J = 25^\circ C$	100	
$T_J, T_{STG}$ Operating Junction and Storage Temperatures	- 65 to 175	$^\circ C$



**Electrical Characteristics @  $T_J = 25^\circ\text{C}$  (unless otherwise specified)**

Parameters	Min	Typ	Max	Units	Test Conditions
$V_{BR}, V_r$ Breakdown Voltage, Blocking Voltage	300	-	-	V	$I_R = 100\mu\text{A}$
$V_F$ Forward Voltage	-	1.0	1.25	V	$I_F = 8\text{A}$
	-	0.83	1.00	V	$I_F = 8\text{A}, T_J = 125^\circ\text{C}$
$I_R$ Reverse Leakage Current	-	0.02	20	$\mu\text{A}$	$V_R = V_R$ Rated
	-	6.0	200	$\mu\text{A}$	$T_J = 125^\circ\text{C}, V_R = V_R$ Rated
$C_T$ Junction Capacitance	-	31	-	pF	$V_R = 300\text{V}$
$L_S$ Series Inductance	-	8	-	nH	Measured lead to lead 5mm from package body

**Dynamic Recovery Characteristics @  $T_C = 25^\circ\text{C}$  (unless otherwise specified)**

Parameters	Min	Typ	Max	Units	Test Conditions
$t_{rr}$ Reverse Recovery Time	-	-	35	ns	$I_F = 1\text{A}, di_F/dt = -50\text{A}/\mu\text{s}, V_R = 30\text{V}$ $T_J = 25^\circ\text{C}$ $T_J = 125^\circ\text{C}$
	-	27	-		
	-	40	-		
$I_{RRM}$ Peak Recovery Current	-	2.2	-	A	$I_F = 8\text{A}$ $di_F/dt = -200\text{A}/\mu\text{s}$ $V_R = 200\text{V}$
	-	5.3	-		
$Q_{rr}$ Reverse Recovery Charge	-	30	-	nC	$T_J = 25^\circ\text{C}$ $T_J = 125^\circ\text{C}$
	-	106	-		

**Thermal - Mechanical Characteristics**

Parameters	Min	Typ	Max	Units
$T_J$ Max. Junction Temperature Range	- 65	-	175	$^\circ\text{C}$
$T_{Stg}$ Max. Storage Temperature Range	- 65	-	175	
$R_{thJC}$ Thermal Resistance, Junction to Case Per Leg	-	1.45	2.5	$^\circ\text{C}/\text{W}$
$R_{thJA}$ <sup>①</sup> Thermal Resistance, Junction to Ambient Per Leg	-	-	70	
$R_{thCS}$ <sup>②</sup> Thermal Resistance, Case to Heatsink	-	0.2	-	
Weight	-	2.0	-	g
	-	0.07	-	(oz)
Mounting Torque	6.0	-	12	Kg-cm
	5.0	-	10	lbf.in

① Typical Socket Mount

② Mounting Surface, Flat, Smooth and Greased

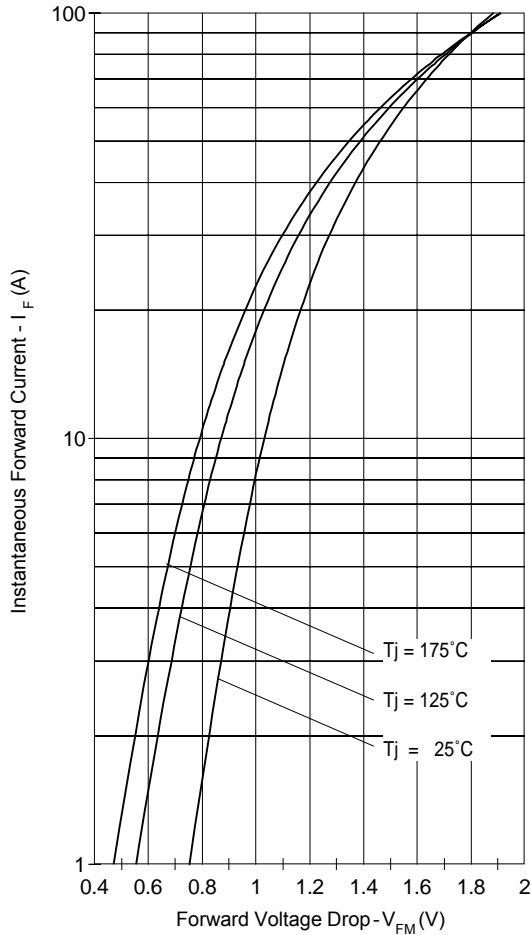


Fig. 1 - Typical Forward Voltage Drop Characteristics

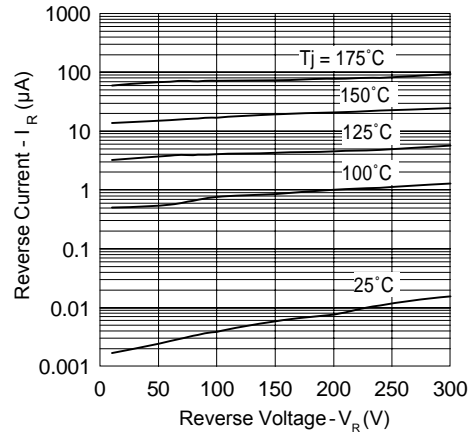


Fig. 2 - Typical Values Of Reverse Current Vs. Reverse Voltage

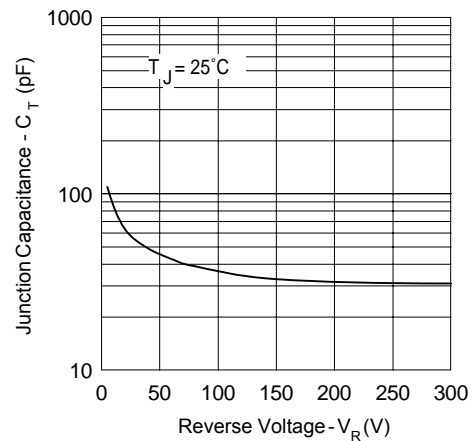


Fig. 3 - Typical Junction Capacitance Vs. Reverse Voltage

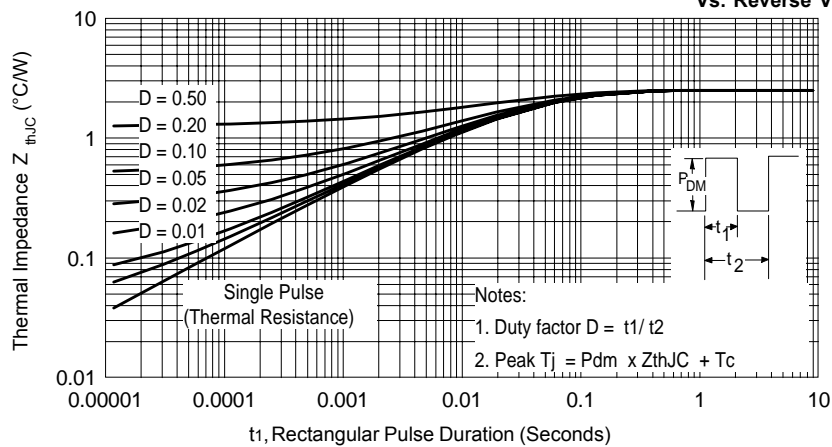
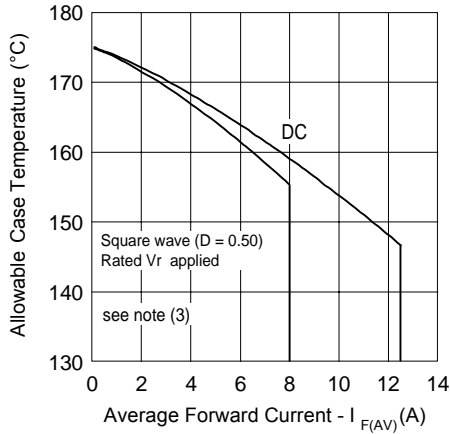
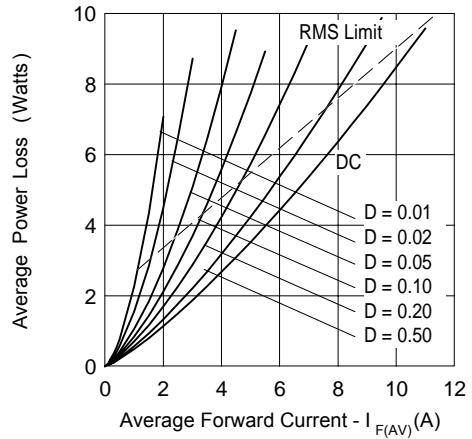


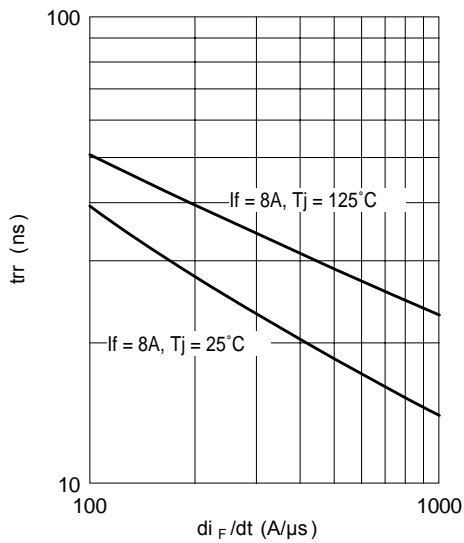
Fig. 4 - Max. Thermal Impedance  $Z_{thJC}$  Characteristics



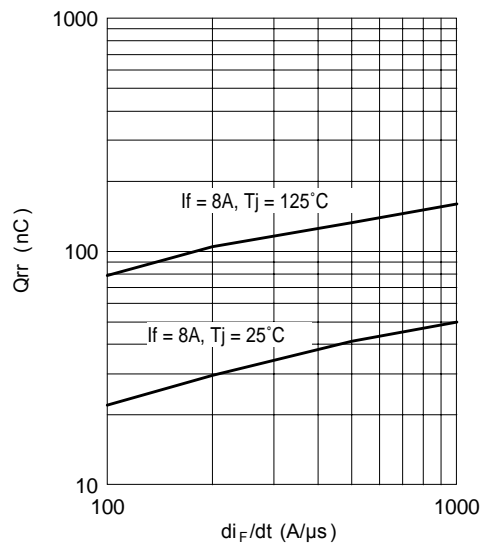
**Fig. 5 - Max. Allowable Case Temperature Vs. Average Forward Current**



**Fig. 6 - Forward Power Loss Characteristics**



**Fig. 7 - Typical Reverse Recovery vs.  $di_F/dt$**

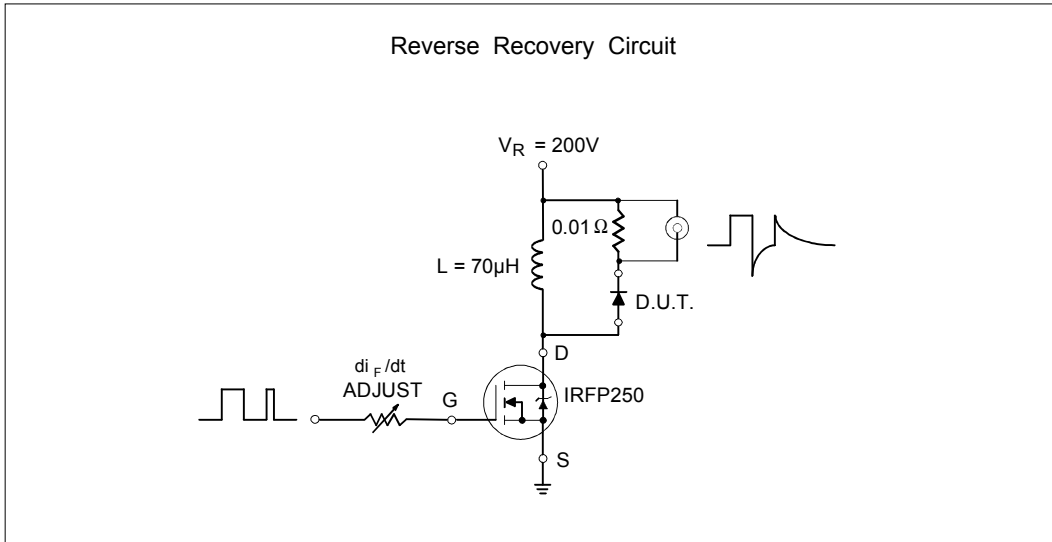


**Fig. 8 - Typical Stored Charge vs.  $di_F/dt$**

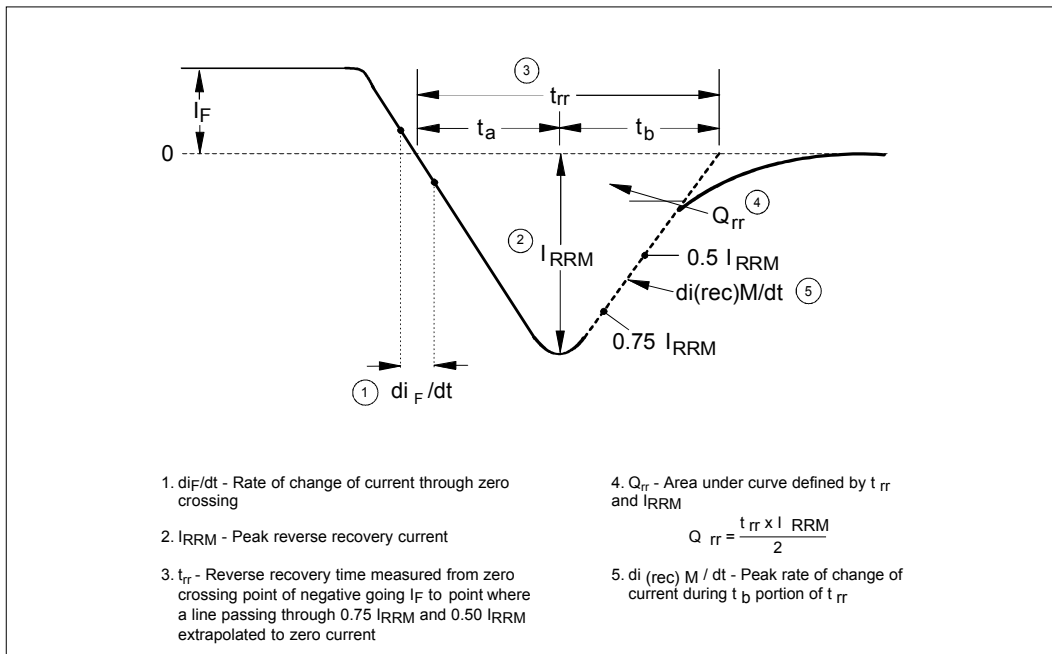
(3) Formula used:  $T_C = T_J - (P_d + P_{d_{REV}}) \times R_{thJC}$

$P_d$  = Forward Power Loss =  $I_{F(AV)} \times V_{FM} @ (I_{F(AV)} / D)$  (see Fig. 6);

$P_{d_{REV}}$  = Inverse Power Loss =  $V_{R1} \times I_R (1 - D)$ ;  $I_R @ V_{R1}$  = rated  $V_R$

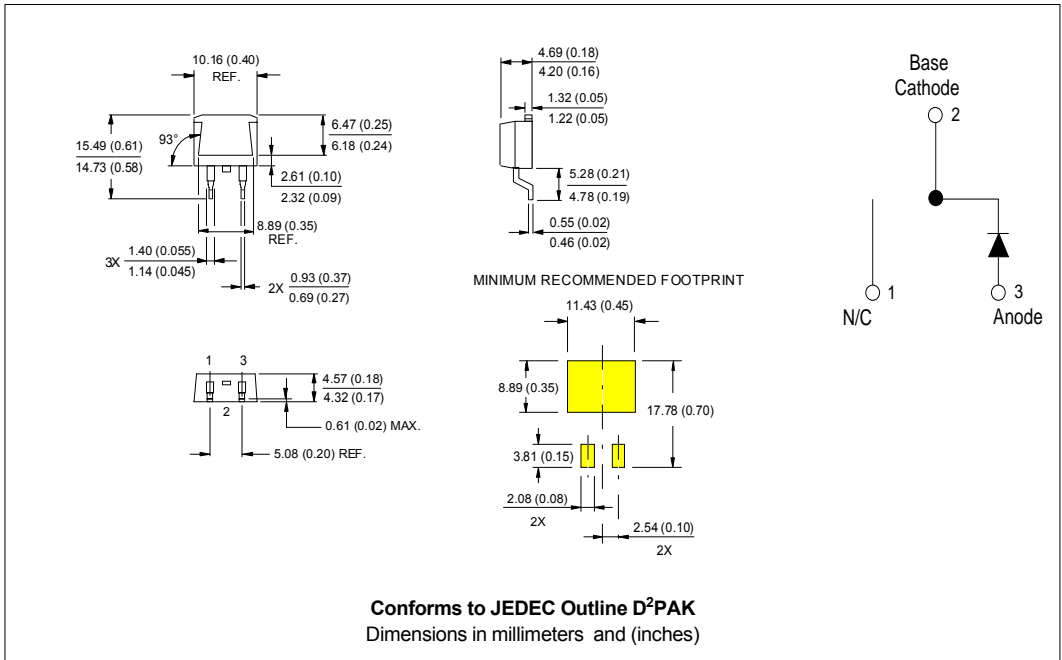
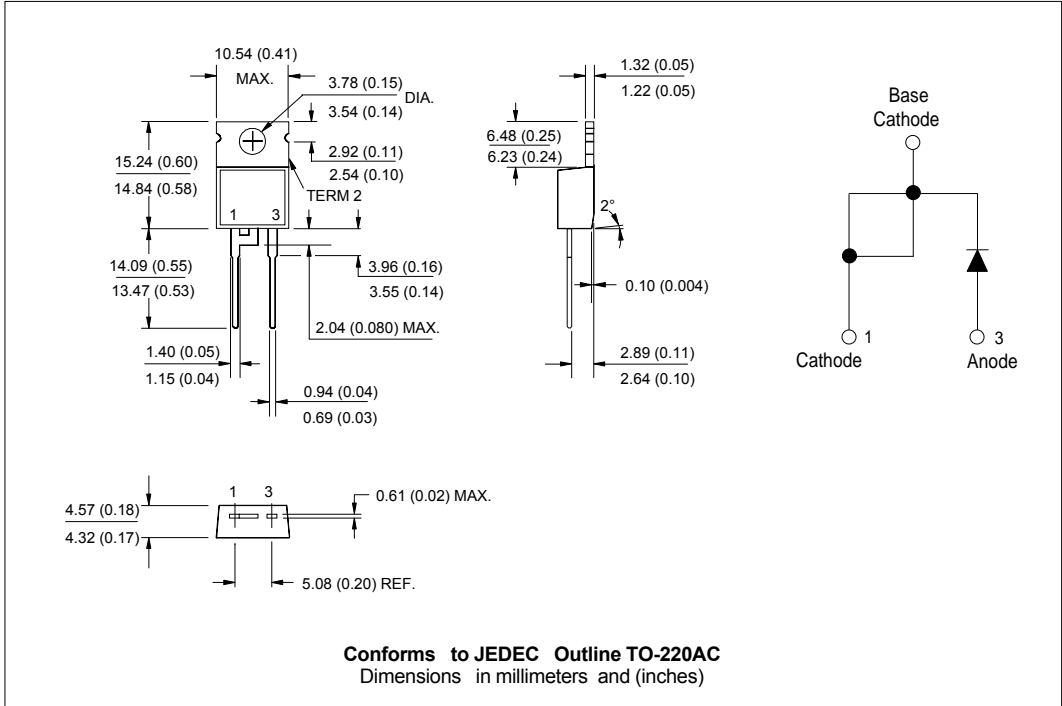


**Fig. 1 - Reverse Recovery Parameter Test Circuit**

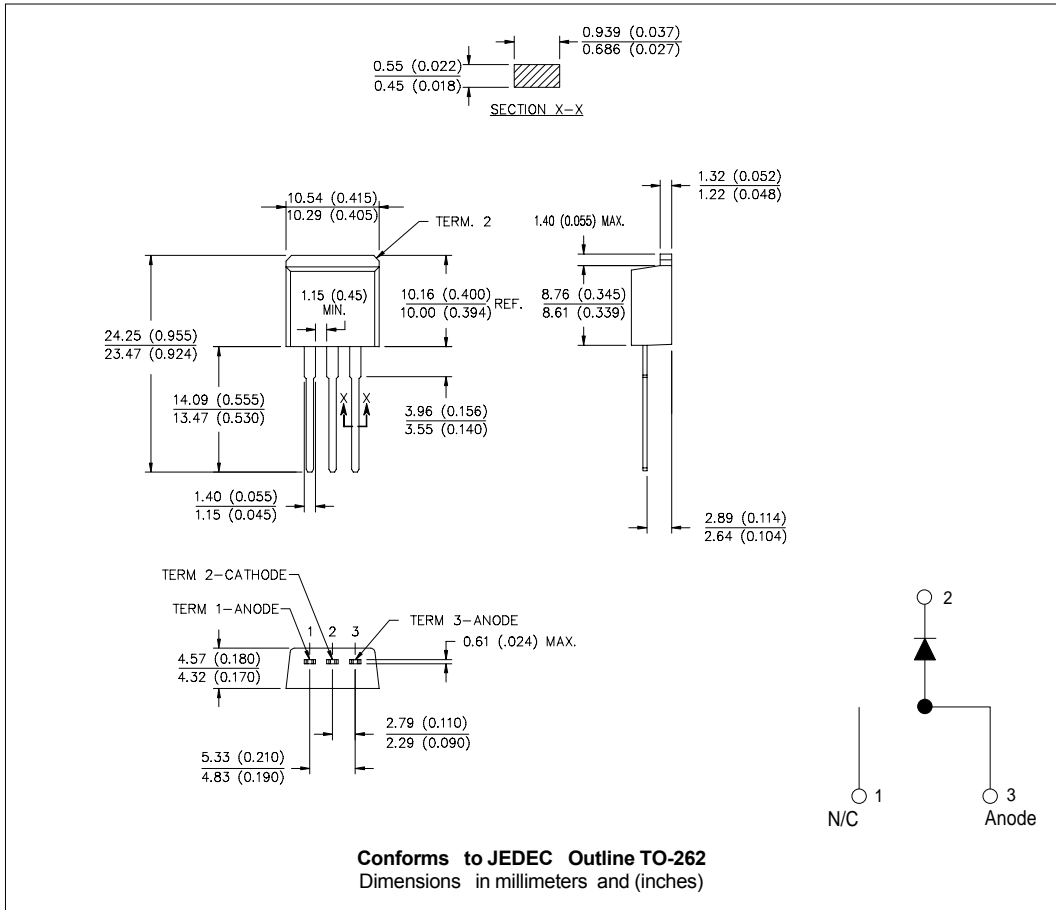


**Fig. 2 - Reverse Recovery Waveform and Definitions**

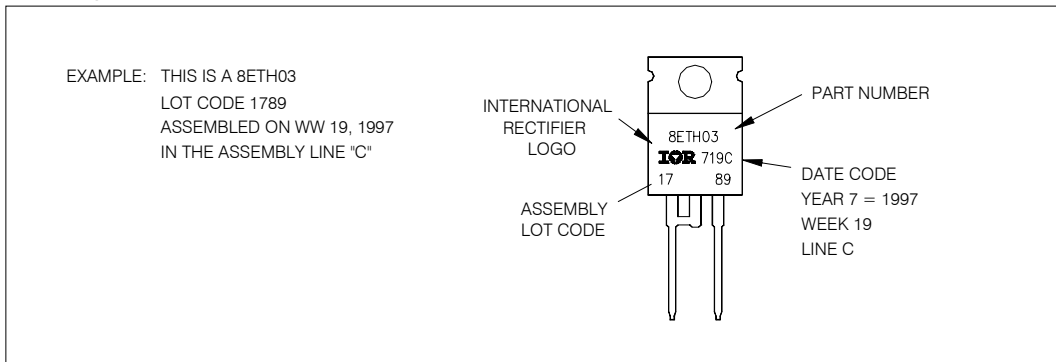
Outline Table



Outline Table



Marking Information



### Ordering Information Table

Device Code					
8	E	T	H	03	-1
①	②	③	④	⑤	⑥
<b>1</b>	-	Current Rating (8 = 8A)			
<b>2</b>	-	E = Single Diode			
<b>3</b>	-	T = TO-220, D <sup>2</sup> Pak			
<b>4</b>	-	H = HyperFast Recovery			
<b>5</b>	-	Voltage Rating (03 = 300V)			
<b>6</b>	-	"-1" = TO-262 Option			
		S = D <sup>2</sup> Pak			
		None = TO-220AC			

Data and specifications subject to change without notice.  
This product has been designed and qualified for Industrial Level.  
Qualification Standards can be found on IR's Web site.

International  
**IR** Rectifier

**IR WORLD HEADQUARTERS:** 233 Kansas St., El Segundo, California 90245, USA Tel: (310) 252-7105

TAC Fax: (310) 252-7309

Visit us at [www.irf.com](http://www.irf.com) for sales contact information. 09/01