

### Features

- High operating temperature
- High output voltage
- Robust cylindrical housing
- Biasing magnet build in
- Signal amplitude independent of speed
- Easily connectable

### Typical applications

- Detection of speed
- Detection of position
- Detection of sense of rotation
- Angle encoder
- Linear position sensing

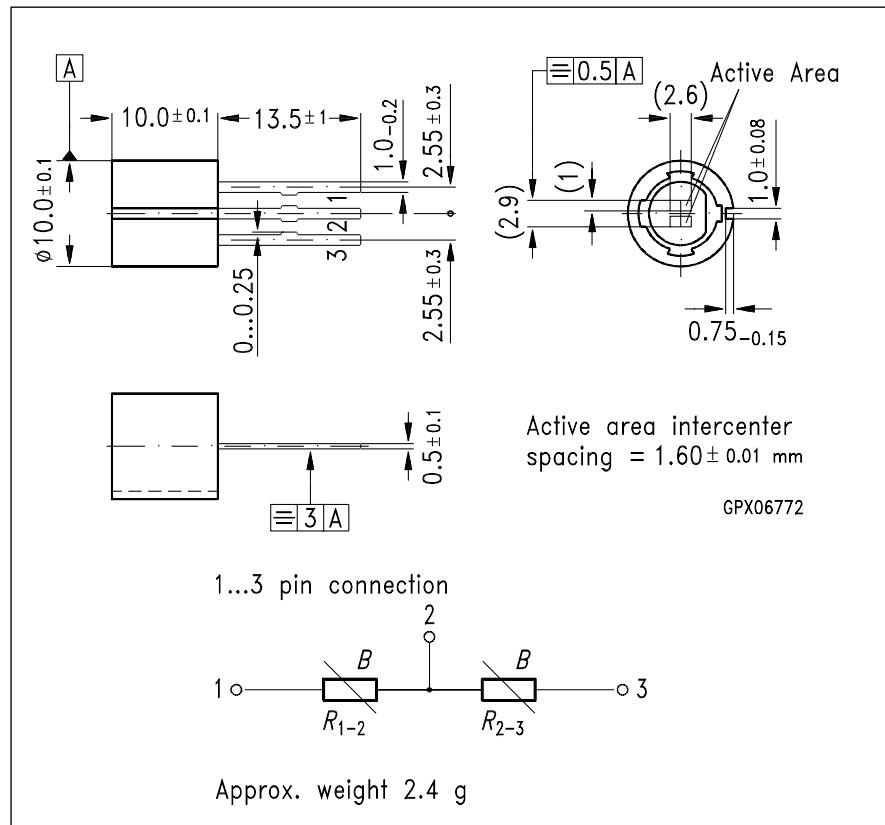

| Type            | Ordering Code  |
|-----------------|----------------|
| FP 210 L 100-22 | Q65210-L100-W4 |

The differential magneto-resistive sensor FP 210 L 100-22 consists of two series coupled L-type InSb/NiSb semiconductor resistors. The resistance value of the MRs, which are mounted onto an insulated ferrite substrate, can be magnetically controlled. The sensor is encapsulated in a plastic package with three in-line contacts extending from the base. The basic resistance of the total system in the unbiased state is  $2 \times 100 \Omega$ . A permanent magnet which supplies a biasing magnetic field is built into the housing.

## Maximum ratings

| Parameter                                       | Symbol    | Value      | Unit |
|---|-----------|------------|------|
| Operating temperature                           | $T_A$     | - 40/ +140 | °C   |
| Storage temperature                             | $T_{stg}$ | - 40/ +150 | °C   |
| Power dissipation <sup>1)</sup>                 | $P_{tot}$ | 400        | mW   |
| Supply voltage <sup>2)</sup>                    | $V_{IN}$  | 7.5        | V    |
| Insulation voltage between terminals and casing | $V_I$     | > 100      | V    |
| Thermal conductivity                            | $G_{thA}$ | ≥ 5        | mW/K |

## Characteristics ( $T_A = 25\text{ °C}$ )

|  |              |           |          |
|--|--------------|-----------|----------|
| Nominal supply voltage   | $V_{IN N}$   | 5         | V        |
| Total resistance, ( $\delta = \infty$ , $I \leq 1\text{ mA}$ )                           | $R_{1-3}$    | 220...400 | $\Omega$ |
| Center symmetry <sup>3)</sup> ( $\delta = \infty$ )                                      | $M$          | ≤ 10      | %        |
| Offset voltage <sup>4)</sup><br>(at $V_{IN N}$ and $\delta = \infty$ )                   | $V_0$        | ≤ 130     | mV       |
| Open circuit output voltage <sup>5)</sup><br>( $V_{IN N}$ and $\delta = 0.2\text{ mm}$ ) | $V_{out pp}$ | > 1000    | mV       |
| Cut-off frequency  | $f_c$        | > 20      | kHz      |

## Measuring arrangements

By approaching a soft iron part close to the sensor a change in its resistance is obtained. The potential divider circuit of the magneto resistor causes a reduction in the temperature dependence of the output voltage  $V_{OUT}$ .

1) Corresponding to diagram  $P_{tot} = f(T_A)$

2) Corresponding to diagram  $V_{IN} = f(T_A)$

3) 
$$M = \frac{R_{1-2} - R_{2-3}}{R_{1-2}} \times 100\% \text{ for } R_{1-2} > R_{2-3}$$

4) Corresponding to measuring circuit in **Fig. 2**

5) Corresponding to measuring circuit in **Fig. 2** and arrangement as shown in **Fig. 1**

**1. Digital revolution counting**

For digital revolution counting, the sensor should be actuated by a magnetically soft iron toothed wheel. The tooth spacing should correspond to about twice the magneto resistor intercenter spacing (see Fig. 1).

The two resistors of the sensor are supplemented by two additional resistors in order to obtain the sensor output voltage as a bridge voltage  $V_{OUT}$ . The output voltage  $V_{OUT}$  without excitation then is 0 V when the offset is compensated.

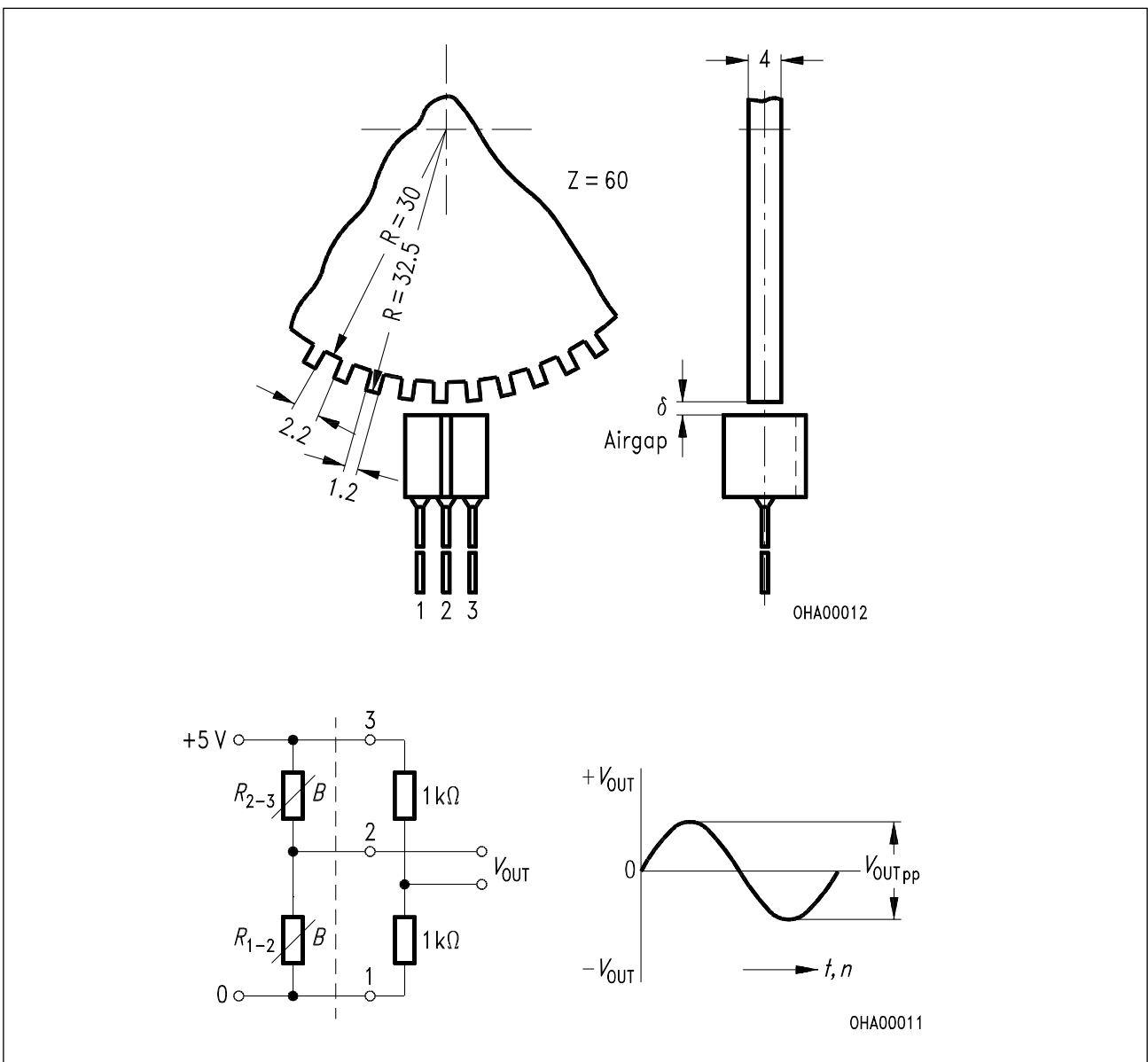

**Fig. 1**  
Schematic representation of a toothed wheel actuating an FP 210 L 100-22

**Fig. 2**  
Measuring circuit and output voltage  $V_{out}$  waveform

**2. Linear distance measurement**

To convert small distances into a proportional electric signal, a small soft iron part of definite width (e.g.  $b = 1.8 \text{ mm}$ ) is moved over the face of the sensor.

Proportional signals for distances up to 1.5 mm can be obtained in this way. The sinusoidal output signal gives a voltage proportional to distance in the zero crossover region (see **Fig. 3**).

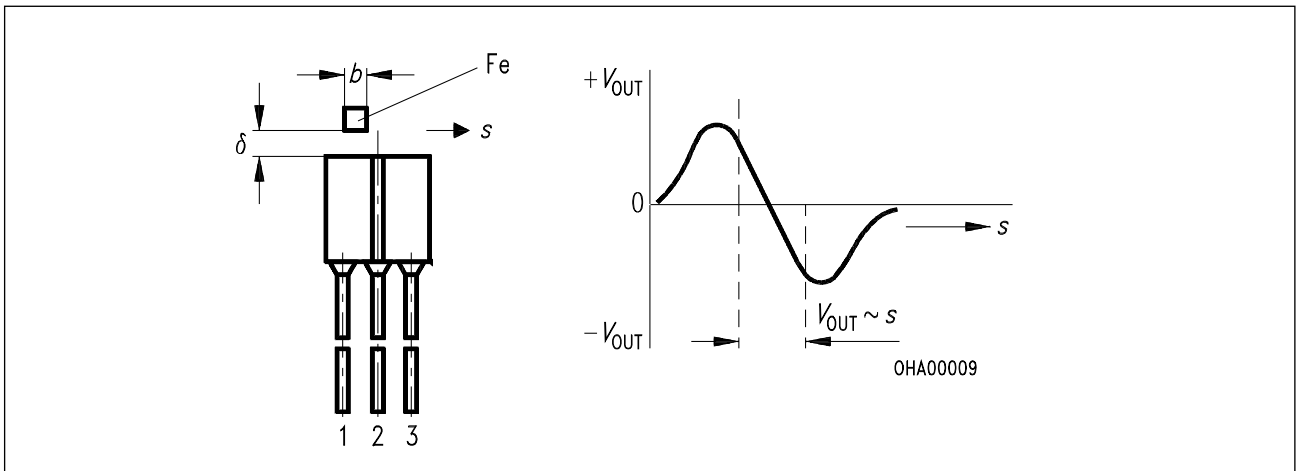

**Fig. 3**  
Arrangement for analogue application

**Maximum supply voltage versus temperature**

$V_{IN} = f(T_A), \delta = \infty$

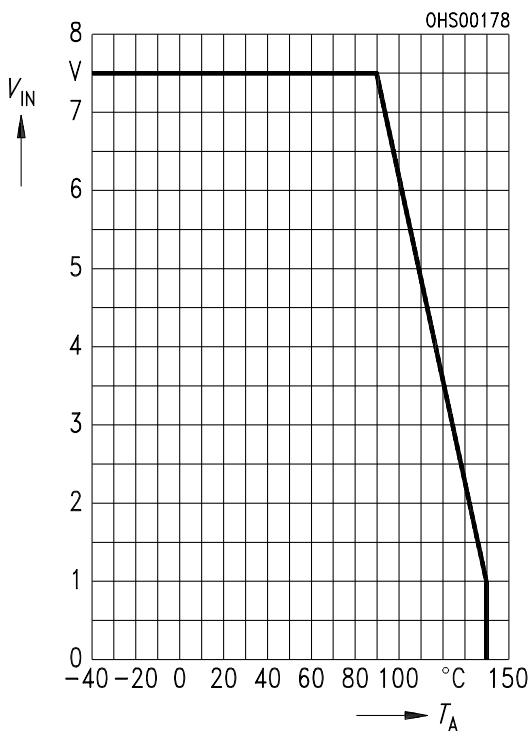

**Output voltage (typical) versus temperature**  $V_{OUTpp} = f(T_A)$ ,  $\delta = 0.2 \text{ mm}$   
 $V_{OUTpp}$  at  $T_A = 25 \text{ }^\circ\text{C} \hat{=} 100\%$

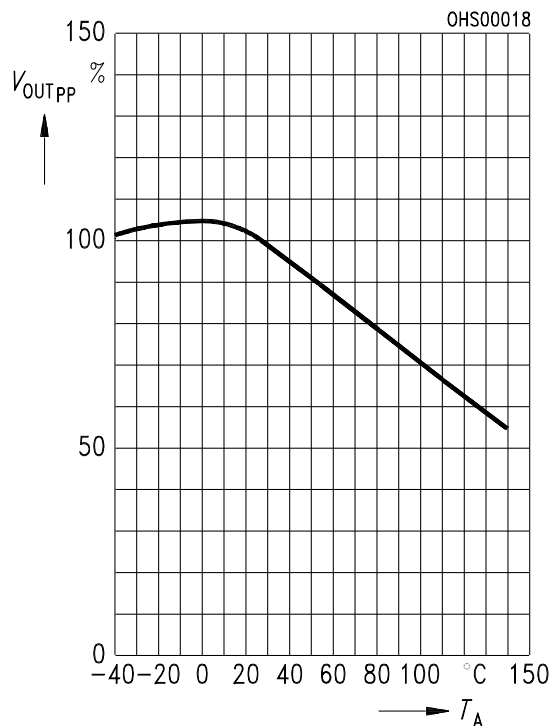

**Output voltage (typical) versus airgap**  $V_{OUTpp} = f(\delta)$ ,  $T_A = 25 \text{ }^\circ\text{C}$   
 $V_{OUTpp}$  at  $\delta = 0.2 \text{ mm} \hat{=} 100\%$

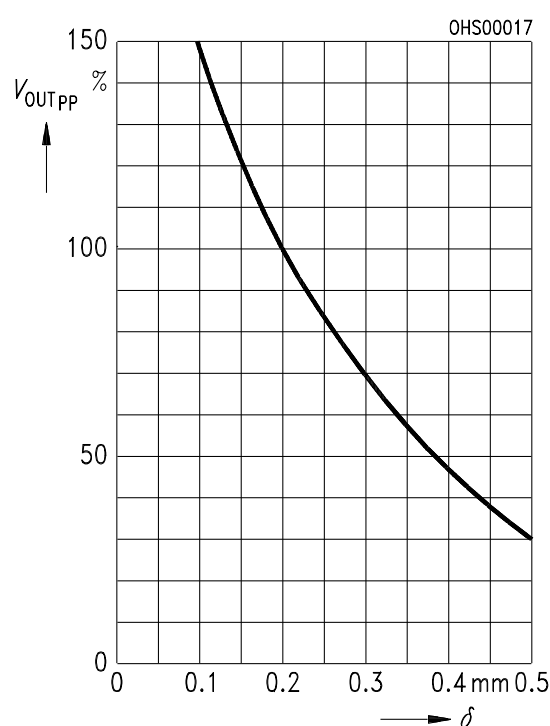

**Total resistance (typical) versus temperature**  $R_{1-3} = f(T_A)$ ,  $\delta = \infty$

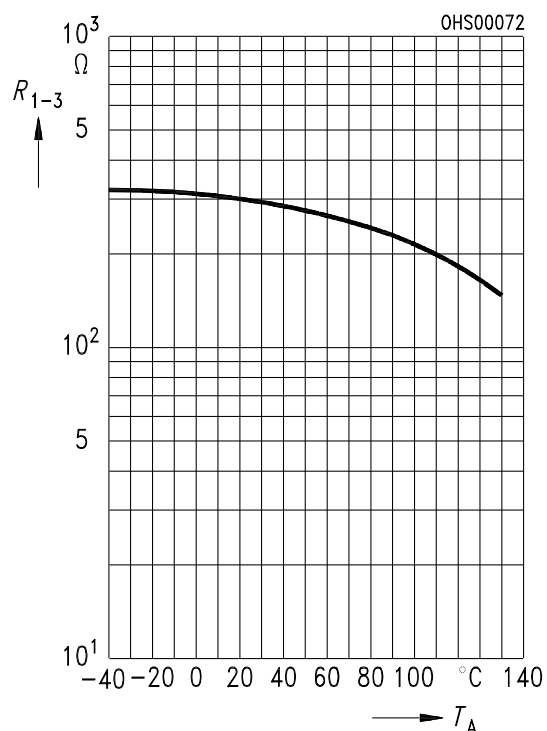

**Max. power dissipation versus temperature**  $P_{tot} = f(T_A)$ ,  $\delta = \infty$

