

# HD14572UB

## Hex Gate

(4-Inverter  
2-input NOR Gate  
2-input NAND Gate)

The HD14572UB hex functional gate finds primary use where low power dissipation and/or high noise immunity is desired. The chip contains four inverters, one NOR gate and one NAND gate.

### FEATURES

- Quiescent Current  $\approx 0.5\text{nA/pkg typ. @5V}$
- Supply Voltage Range = 3 to 18V
- NOR Input Pin Adjacent to  $V_{SS}$  Pin to Simplify Use As An Inverter
- NAND Input Pin Adjacent to  $V_{DD}$  Pin to Simplify Use As An Inverter
- NOR Output Pin Adjacent to Inverter Input Pin For OR Application
- NAND Output Pin Adjacent to Inverter Input Pin For AND Application
- Capable of Driving One Low-power Schottky TTL Load Over the Rated Temperature Range

### PIN ARRANGEMENT

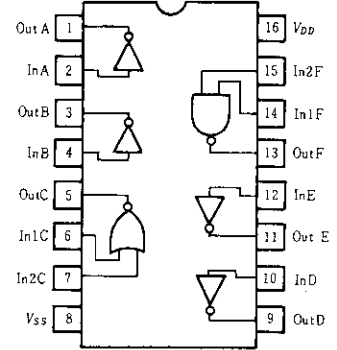

(Top View)

### CIRCUIT SCHEMATIC

#### Inverter

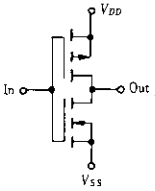

#### NOR

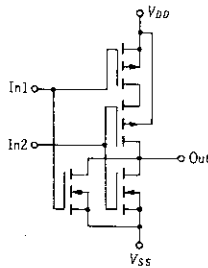

#### NAND

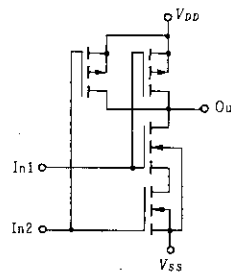

### SWITCHING TIME TEST CIRCUIT

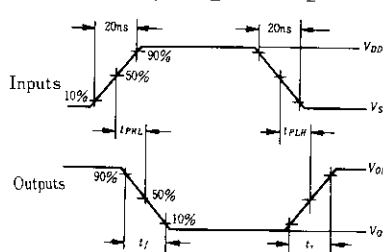
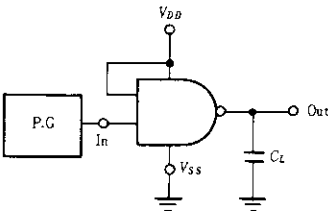
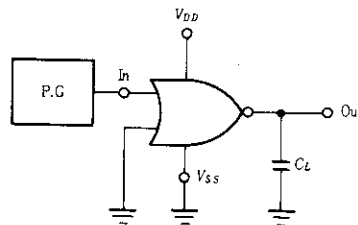
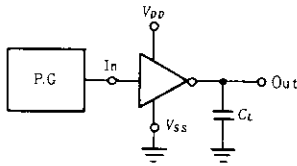

**ELECTRICAL CHARACTERISTICS**

Characteristic	Symbol	$V_{DD}(V)$	Test Conditions	-40°C		25°C			85°C		Unit
				min	max	min	typ	max	min	max	
Output Voltage	$V_{OL}$	5.0	$V_{in} = V_{DD}$	—	0.05	—	0	0.05	—	0.05	V
		10		—	0.05	—	0	0.05	—	0.05	
		15		—	0.05	—	0	0.05	—	0.05	
	$V_{OH}$	5.0	$V_{in} = 0$	4.95	—	4.95	5.0	—	4.95	—	V
		10		9.95	—	9.95	10	—	9.95	—	
		15		14.95	—	14.95	15	—	14.95	—	
Input Voltage	$V_{IL}$	5.0	$V_{ovl} = 4.5V$	—	1.0	—	2.25	1.0	—	1.0	V
		10	$V_{ovl} = 9.0V$	—	2.0	—	4.50	2.0	—	2.0	
		15	$V_{ovl} = 13.5V$	—	2.5	—	6.75	2.5	—	2.5	
	$V_{IH}$	5.0	$V_{ovl} = 0.5V$	4.0	—	4.0	2.75	—	4.0	—	V
		10	$V_{ovl} = 1.0V$	8.0	—	8.0	5.50	—	8.0	—	
		15	$V_{ovl} = 1.5V$	12.5	—	12.5	8.25	—	12.5	—	
Output Drive Current	$I_{OH}$	5.0	$V_{OH} = 2.5V$	-1.0	—	-0.8	-1.7	—	-0.6	—	mA
		5.0	$V_{OH} = 4.6V$	-0.2	—	-0.16	-0.36	—	-0.12	—	
		10	$V_{OH} = 9.5V$	-0.5	—	-0.4	-0.9	—	-0.3	—	
	$I_{OL}$	5.0	$V_{OL} = 0.4V$	0.52	—	0.44	0.88	—	0.36	—	mA
		10	$V_{OL} = 0.5V$	1.3	—	1.1	2.25	—	0.9	—	
		15	$V_{OL} = 1.5V$	3.6	—	3.0	8.8	—	2.4	—	
Input Current	$I_{in}$	15		—	$\pm 0.3$	—	+0.0001	$\pm 0.3$	—	$\pm 1.0$	$\mu A$
Input Capacitance	$C_{in}$		$V_{in} = 0$	—	—	—	5.0	7.5	—	—	pF
Quiescent Current	$I_{DD}$	5.0	Zero Signal, per Package	—	0.5	—	0.0005	0.5	—	3.8	$\mu A$
		10		—	1.0	—	0.0010	1.0	—	7.5	
		15		—	2.0	—	0.0015	2.0	—	15	
Total Supply Current*	$I_T$	5.0	Dynamic + $I_{DD}$ , per Gate,	—	—	—	1.89	—	—	—	$\mu A$
		10		—	—	—	3.80	—	—	—	
		15		—	—	—	5.68	—	—	—	

\* To calculate total supply current at frequency other than 1kHz.  
 @  $V_{DD} = 5.0V$   $I_T = (1.89\mu A/kHz)f + I_{DD}$ . @  $V_{DD} = 10V$   $I_T = (3.80\mu A/kHz)f + I_{DD}$ . @  $V_{DD} = 15V$   $I_T = (5.68\mu A/kHz)f + I_{DD}$

**SWITCHING CHARACTERISTICS ( $C_L = 50pF, T_a = 25^\circ C$ )**

Characteristic	Symbol	$V_{DD}(V)$	min	typ	max	Unit
Output Rise Time	$t_r$	5.0	—	180	400	ns
		10	—	90	200	
		15	—	65	160	
Output Fall Time	$t_f$	5.0	—	100	200	ns
		10	—	50	100	
		15	—	37	80	
Propagation Delay Time	$t_{PLH}$	5.0	—	115	200	ns
		10	—	55	110	
		15	—	40	85	
	$t_{FHL}$	5.0	—	115	200	ns
		10	—	55	110	
		15	—	40	85	



Hitachi Code	DP-16
JEDEC	Conforms
EIAJ	Conforms
Weight (reference value)	1.07 g

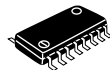

\*Dimension including the plating thickness  
 Base material dimension

Hitachi Code	FP-16DA
JEDEC	—
EIAJ	Conforms
Weight (reference value)	0.24 g

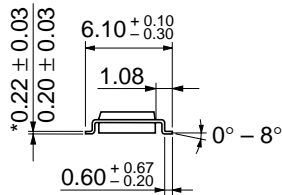

\*Dimension including the plating thickness  
Base material dimension

Hitachi Code	FP-16DN
JEDEC	Conforms
EIAJ	Conforms
Weight (reference value)	0.15 g

## Cautions

1. Hitachi neither warrants nor grants licenses of any rights of Hitachi's or any third party's patent, copyright, trademark, or other intellectual property rights for information contained in this document. Hitachi bears no responsibility for problems that may arise with third party's rights, including intellectual property rights, in connection with use of the information contained in this document.
2. Products and product specifications may be subject to change without notice. Confirm that you have received the latest product standards or specifications before final design, purchase or use.
3. Hitachi makes every attempt to ensure that its products are of high quality and reliability. However, contact Hitachi's sales office before using the product in an application that demands especially high quality and reliability or where its failure or malfunction may directly threaten human life or cause risk of bodily injury, such as aerospace, aeronautics, nuclear power, combustion control, transportation, traffic, safety equipment or medical equipment for life support.
4. Design your application so that the product is used within the ranges guaranteed by Hitachi particularly for maximum rating, operating supply voltage range, heat radiation characteristics, installation conditions and other characteristics. Hitachi bears no responsibility for failure or damage when used beyond the guaranteed ranges. Even within the guaranteed ranges, consider normally foreseeable failure rates or failure modes in semiconductor devices and employ systemic measures such as fail-safes, so that the equipment incorporating Hitachi product does not cause bodily injury, fire or other consequential damage due to operation of the Hitachi product.
5. This product is not designed to be radiation resistant.
6. No one is permitted to reproduce or duplicate, in any form, the whole or part of this document without written approval from Hitachi.
7. Contact Hitachi's sales office for any questions regarding this document or Hitachi semiconductor products.

# HITACHI

## Hitachi, Ltd.

Semiconductor & Integrated Circuits.  
Nippon Bldg., 2-6-2, Ohte-machi, Chiyoda-ku, Tokyo 100-0004, Japan  
Tel: Tokyo (03) 3270-2111 Fax: (03) 3270-5109

URL      North America      : <http://semiconductor.hitachi.com/>  
             Europe                : <http://www.hitachi-eu.com/hel/ecg>  
             Asia (Singapore)      : <http://www.has.hitachi.com.sg/grp3/sicd/index.htm>  
             Asia (Taiwan)            : [http://www.hitachi.com.tw/E/Product/SICD\\_Frame.htm](http://www.hitachi.com.tw/E/Product/SICD_Frame.htm)  
             Asia (HongKong)        : <http://www.hitachi.com.hk/eng/bo/grp3/index.htm>  
             Japan                        : <http://www.hitachi.co.jp/Sicd/indx.htm>

## For further information write to:

Hitachi Semiconductor  
(America) Inc.  
179 East Tasman Drive,  
San Jose, CA 95134  
Tel: <1> (408) 433-1990  
Fax: <1> (408) 433-0223

Hitachi Europe GmbH  
Electronic components Group  
Dornacher Straße 3  
D-85622 Feldkirchen, Munich  
Germany  
Tel: <49> (89) 9 9180-0  
Fax: <49> (89) 9 29 30 00

Hitachi Europe Ltd.  
Electronic Components Group.  
Whitebrook Park  
Lower Cookham Road  
Maidenhead  
Berkshire SL6 8YA, United Kingdom  
Tel: <44> (1628) 585000  
Fax: <44> (1628) 778322

Hitachi Asia Pte. Ltd.  
16 Collyer Quay #20-00  
Hitachi Tower  
Singapore 049318  
Tel: 535-2100  
Fax: 535-1533

Hitachi Asia Ltd.  
Taipei Branch Office  
3F, Hung Kuo Building, No.167,  
Tun-Hwa North Road, Taipei (105)  
Tel: <886> (2) 2718-3666  
Fax: <886> (2) 2718-8180

Hitachi Asia (Hong Kong) Ltd.  
Group III (Electronic Components)  
7/F., North Tower, World Finance Centre,  
Harbour City, Canton Road, Tsim Sha Tsui,  
Kowloon, Hong Kong  
Tel: <852> (2) 735 9218  
Fax: <852> (2) 730 0281  
Telex: 40815 HITEC HX

Copyright ' Hitachi, Ltd., 1999. All rights reserved. Printed in Japan.

**HITACHI**