

PNZ331F

PIN Photodiode

For optical fiber communication systems

■ Features

- Metal package with shield pin
- High coupling capability suitable for plastic fiber and glass fiber
- High quantum efficiency
- High-speed response

■ Absolute Maximum Ratings (Ta = 25°C)

Parameter	Symbol	Ratings	Unit
Reverse voltage (DC)	V_R	30	V
Power dissipation	P_D	50	mW
Operating ambient temperature	T_{opr}	-25 to +100	°C
Storage temperature	T_{stg}	-40 to +100	°C

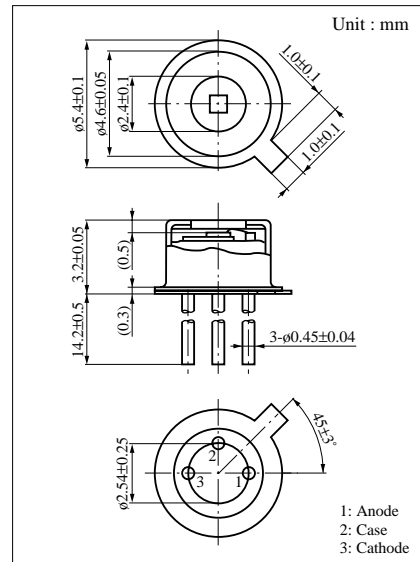

■ Dimensions of detection area

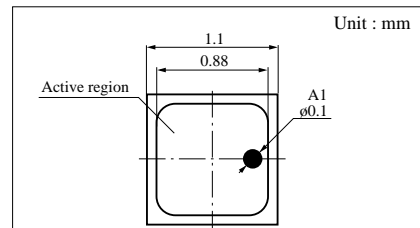

■ Electro-Optical Characteristics (Ta = 25°C)

Parameter	Symbol	Conditions	min	typ	max	Unit
Dark current	I_D	$V_R = 10V$		0.1	10	nA
Photo current	I_L	$V_R = 10V, L = 1000 \text{ lx}^*1$	4	7		μA
Peak sensitivity wavelength	λ_p	$V_R = 10V$		900		nm
Frequency characteristics	f_c^{*2}	$V_R = 10V, R_L = 50\Omega$		50		MHz
Capacitance between pins	C_t	$V_R = 10V$		3		pF
Photodetection sensitivity	R	$V_R = 10V, \lambda = 800\text{nm}$	0.45	0.55		A/W
Acceptance half angle	θ	Measured from the optical axis to the half power point		40		deg.
Photodetection surface shape	D	Effective photodetection area		□0.88		mm

Note 1) Spectral sensitivity : Sensitivity at wavelengths exceeding 400 nm as a percentage, is 100% to maximum sensitivity.

Note 2) This product is not designed to withstand electromagnetic radiation or heavy-charge particles.

Note 3) The glass strength of this product cannot withstand loads of 0.5 kg or greater. This fact needs to be taken into consideration if optical fibers are to be mounted on the product.

*1 Measurements were made using a tungsten lamp (color temperature T = 2856K) as a light source.

*2 Switching time measurement circuit (see figure below) Note : Detection photo current -3 dB

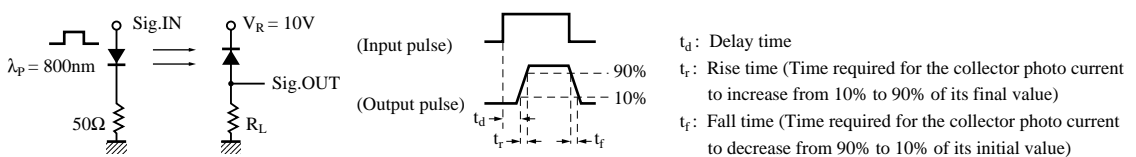

$P_D - T_a$

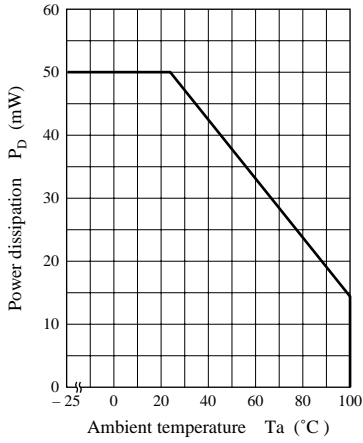

$I_L - L$

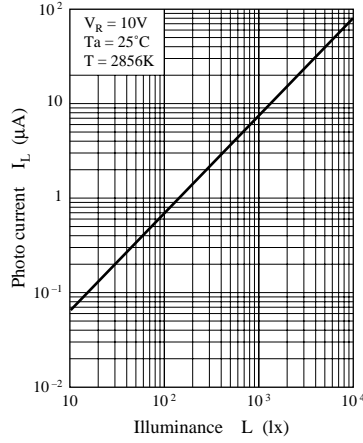

$I_L - P$

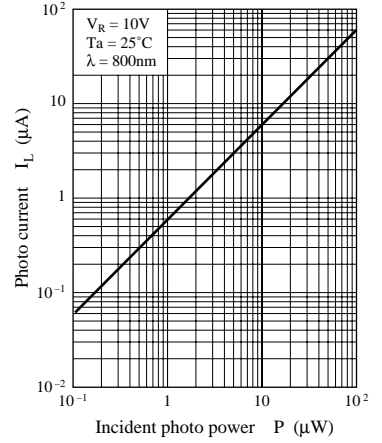

$I_D - V_R$

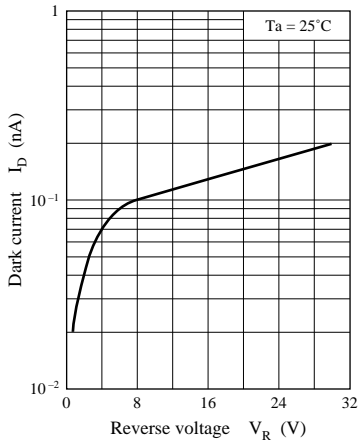

$I_L - T_a$

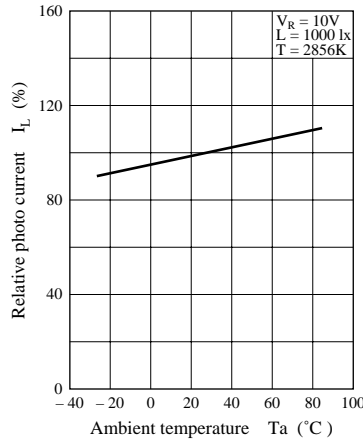

$I_D - T_a$

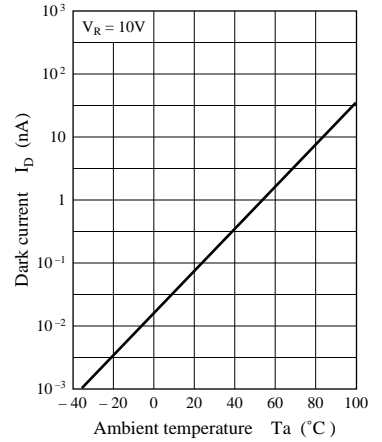

$I_L - T_a$

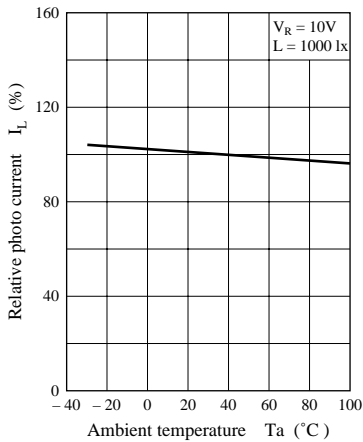

Spectral sensitivity characteristics

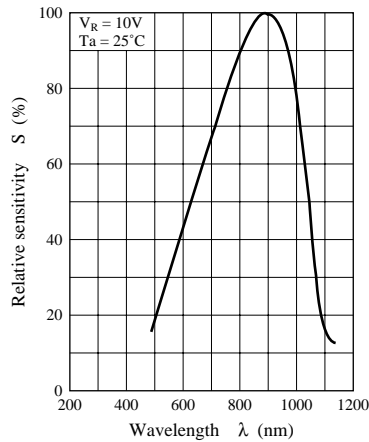

Frequency characteristics

