

2N3418

APPLICATIONS:

- Power Supply
- Pulse Amplifier
- High Frequency Power Switching

FEATURES:

- Meets MIL-S-19500/393
- Collector-Base Voltage: up to 85V
- Peak Collector Current: 5A
- High Power Dissipation in TO-5: 15W @ T_C = 100°C
- Fast Switching

**3 Amp, 85V,
 NPN Silicon Power
 Transistors
 JAN, JTX, JTXV, JANS**

DESCRIPTION:

These power transistors are produced by PPC's DOUBLE DIFFUSED PLANAR process. This technology produces high voltage devices with excellent switching speeds, frequency response, gain linearity, saturation voltages, high current gain, and safe operating areas. They are intended for use in Commercial, Industrial, and Military power switching, amplifier, and regulator applications.

Ultrasonically bonded leads and controlled die mount techniques are utilized to further increase the SOA capability and inherent reliability of these devices. The temperature range to 200°C permits reliable operation in high ambients, and the hermetically sealed package insures maximum reliability and long life.

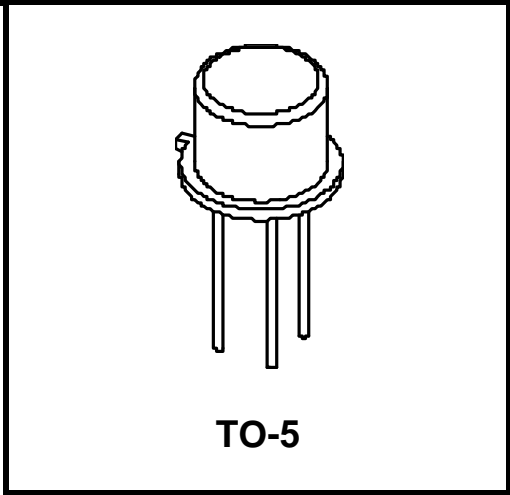

ABSOLUTE MAXIMUM RATINGS:

SYMBOL	CHARACTERISTIC	VALUE	UNITS
V _{CBO} *	Collector-Base Voltage	85	Volts
V _{CEO} *	Collector-Emitter Voltage	60	Volts
V _{EBO} *	Emitter-Base Voltage	8	Volts
I _C *	D.C. Collector Current	3	Amps
I _C *	Peak Collector Current	5	Amps
T _{STG} *	Storage Temperature	-65 to 200	°C
T _J *	Operating Junction Temperature	-65 to 200	°C
P _T *	Power Dissipation		
	T _C = 25°C Ambient	1.0	Watts
	T _C = 100°C Case	15	Watts

* Indicates MIL-S-19500/393

**ELECTRICAL CHARACTERISTICS:
 (25°C Case Temperature Unless Otherwise Noted)**

SYMBOL	CHARACTERISTIC	TEST CONDITIONS	VALUE		Units
			Min.	Max.	
BV_{CEO}^*	Collector-Emitter Breakdown Voltage	$I_C = 50 \text{ mAdc}$, Cond. D (Note 1)	60	----	Vdc
I_{CEX}^*	Collector-Emitter Cutoff Current	$V_{EB} = 0.5 \text{ Vdc}$, Cond. A, $V_{CE} = 80 \text{ Vdc}$ $V_{EB} = 0.5 \text{ Vdc}$, Cond. A, $T_A = 150^\circ\text{C}$, $V_{CE} = 80 \text{ Vdc}$	----	0.3 50	μAdc μAdc
I_{CEO}^*	Collector-Emitter Cutoff Current	$V_{CE} = 45 \text{ Vdc}$, Cond. D	----	5.0	μAdc
I_{EBO}^*	Emitter-Base Cutoff Current	$V_{EB} = 6 \text{ Vdc}$, Cond. D $V_{EB} = 8 \text{ Vdc}$, Cond. D	----	0.5 10	μAdc μAdc
hFE^*	D.C. Current Gain (Note 1)	$I_C = 100 \text{ mAdc}$, $V_{CE} = 2 \text{ Vdc}$ $I_C = 1 \text{ Adc}$, $V_{CE} = 2 \text{ Vdc}$ $I_C = 2 \text{ Adc}$, $V_{CE} = 2 \text{ Vdc}$ $I_C = 5 \text{ Adc}$, $V_{CE} = 5 \text{ Vdc}$ $I_C = 1 \text{ Adc}$, $V_{CE} = 2 \text{ Vdc}$, $T_A = -55^\circ\text{C}$	20 20 15 10 10	----	----
$V_{CE(sat)}^*$	Collector-Emitter Saturation Voltage (Note 1)	$I_C = 1 \text{ Adc}$, $I_B = 0.1 \text{ Adc}$ $I_C = 2 \text{ Adc}$, $I_B = 0.2 \text{ Adc}$	----	0.25 0.5	Vdc Vdc
$V_{BE(sat)}^*$	Base-Emitter Saturation Voltage (Note 1)	$I_C = 1 \text{ Adc}$, $I_B = 0.1 \text{ Adc}$ $I_C = 2 \text{ Adc}$, $I_B = 0.2 \text{ Adc}$	0.6 0.7	1.2 1.4	Vdc Vdc
$I_{S/b}^*$	Forward Biased Second Breakdown	$V_{CE} = 5 \text{ Vdc}$, $T_C = 100^\circ\text{C}$ $V_{CE} = 37 \text{ Vdc}$, $T_C = 100^\circ\text{C}$ $V_{CE} = 60 \text{ Vdc}$, $T_C = 100^\circ\text{C}$	3 0.4 185	----	Adc Adc mAdc
$E_{S/b}^*$	Unclamped Reverse Biased Second Breakdown	$I_C = 3 \text{ Adc}$, $L = 10 \text{ mH}$, Base Open	45	----	mj
$E_{S/b}^*$	clamped Reverse Biased Second Breakdown	$I_C = 3 \text{ Adc}$, $L = 40 \text{ mH}$, $V_{Clamp} = 85\text{V}$	180	----	mj
f_T^*	Gain Bandwidth Product	$I_C = 0.1 \text{ Adc}$, $V_{CE} = 10 \text{ Vdc}$, $f = 20 \text{ MHz}$	26	160	MHz
C_{Ob}^*	Output Capacitance	$V_{CB} = 10 \text{ Vdc}$, $I_E = 0$, $f = 1 \text{ MHz}$	----	150	pf
t_{on}	Turn-on Time	$I_C = 1 \text{ Adc}$, $I_{B1} = -I_{B2} = 0.1 \text{ Adc}$	----	0.3	μs
t_{off}	Turn-off Time	$I_C = 1 \text{ Adc}$, $I_{B1} = -I_{B2} = 0.1 \text{ Adc}$	----	1.2	μs

Note 1: Pulse Test: Pulse width = 300 $\mu\text{Sec.}$, duty cycle $\leq 2\%$.

* Indicates MIL-S-19500/393

2N3418

PACKAGE MECHANICAL DATA:

