

TOSHIBA InGaAlP LED
TLRE62T, TLRME62T, TLSE62T, TLOE62T
TLYE62T, TLGE62T, TLPGE62T

PANEL CIRCUIT INDICATOR

- 3 mm Package
- InGaAlP Technology
- All Plastic Mold Type
- Transparent Lens
- High Intensity Light Emission
- Excellent Low Current Light Output
- Applications: Outdoor Message Signboards, Safety equipment, Automotive, Security Equipment

LINE-UP

PRODUCT NAME	COLOR	MATERIAL
TLRE62T	Red	InGaAlP
TLRME62T	Red	
TLSE62T	Red	
TLOE62T	Orange	
TLYE62T	Yellow	
TLGE62T	Green	
TLPGE62T	Pure Green	

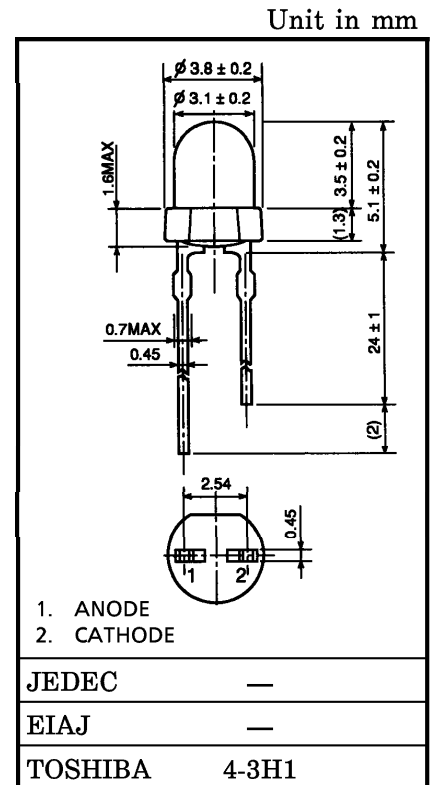

Weight : 0.14 g

MAXIMUM RATINGS (Ta = 25°C)

PRODUCT NAME	FORWARD CURRENT I _F (mA)	REVERSE VOLTAGE V _R (V)	POWER DISSIPATION P _D (mW)	OPERATING TEMPERATURE T _{opr} (°C)	STORAGE TEMPERATURE T _{stg} (°C)
TLRE62T	50	4	120	-40~100	-40~120
TLRME62T	50	4	120	-40~100	-40~120
TLSE62T	50	4	120	-40~100	-40~120
TLOE62T	50	4	120	-40~100	-40~120
TLYE62T	50	4	120	-40~100	-40~120
TLGE62T	50	4	120	-40~100	-40~120
TLPGE62T	50	4	120	-40~100	-40~120

961001EAC1

- TOSHIBA is continually working to improve the quality and the reliability of its products. Nevertheless, semiconductor devices in general can malfunction or fail due to their inherent electrical sensitivity and vulnerability to physical stress. It is the responsibility of the buyer, when utilizing TOSHIBA products, to observe standards of safety, and to avoid situations in which a malfunction or failure of a TOSHIBA product could cause loss of human life, bodily injury or damage to property. In developing your designs, please ensure that TOSHIBA products are used within specified operating ranges as set forth in the most recent products specifications. Also, please keep in mind the precautions and conditions set forth in the TOSHIBA Semiconductor Reliability Handbook.
- Gallium arsenide (GaAs) is a substance used in the products described in this document. GaAs dust and fumes are toxic. Do not break, cut or pulverize the product, or use chemicals to dissolve them. When disposing of the products, follow the appropriate regulations. Do not dispose of the products with other industrial waste or with domestic garbage.
- The information contained herein is presented only as a guide for the applications of our products. No responsibility is assumed by TOSHIBA CORPORATION for any infringements of intellectual property or other rights of the third parties which may result from its use. No license is granted by implication or otherwise under any intellectual property or other rights of TOSHIBA CORPORATION or others.
- The information contained herein is subject to change without notice.

ELECTRICAL AND OPTICAL CHARACTERISTICS (Ta = 25°C)

PRODUCT NAME	TYP. EMISSION WAVELENGTH			LUMINOUS INTENSITY I _V			FORWARD VOLTAGE V _F			REVERSE CURRENT I _R		
	λ _d	λ _p	Δλ	I _F	MIN	TYP.	I _F	TYP.	MAX	I _F	MAX	V _R
TLRE62T	630	(644)	20	20	47.6	120	20	1.9	2.4	20	50	4
TLRME62T	626	(636)	23	20	47.6	180	20	1.9	2.4	20	50	4
TLSE62T	613	(623)	20	20	85.0	200	20	1.9	2.4	20	50	4
TLOE62T	605	(612)	20	20	153	350	20	2.0	2.4	20	50	4
TLYE62T	587	(590)	17	20	85	250	20	2.0	2.4	20	50	4
TLGE62T	571	(574)	17	20	47.6	110	20	2.0	2.4	20	50	4
TLPGE62T	558	(562)	14	20	15.3	45	20	2.1	2.4	20	50	4
Unit	nm			mA	mcd		mA	V		mA	μA	V

PRECAUTIONS

Please be careful of the following:

- Soldering temperature: 260°C max, soldering time: 3 s max
(soldering portion of lead: up to 2 mm from the body of the device)
- If the lead is formed, the lead should be formed up to 5 mm from the body of the device without forming stress to the resin. Soldering should be performed after lead forming.
- This visible LED lamp also emits some IR light.
If a photodetector is located near the LED lamp, please ensure that it will not be affected by this IR light.

TLRE62T

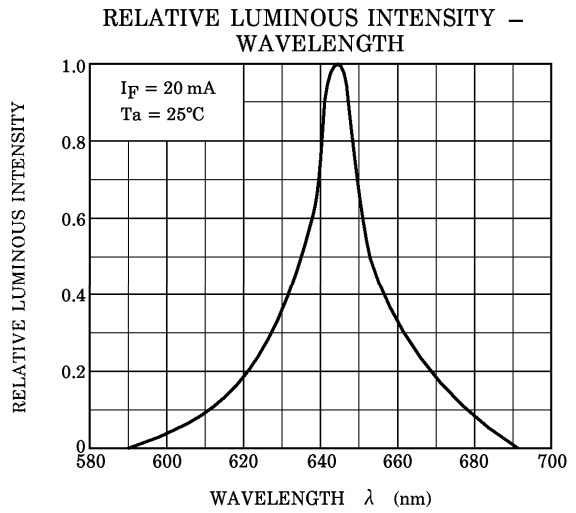
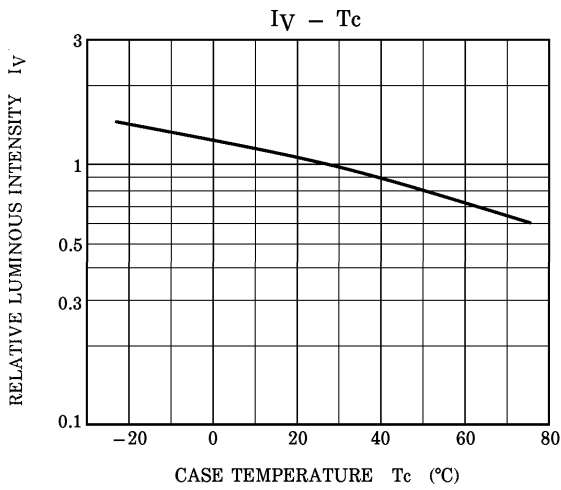
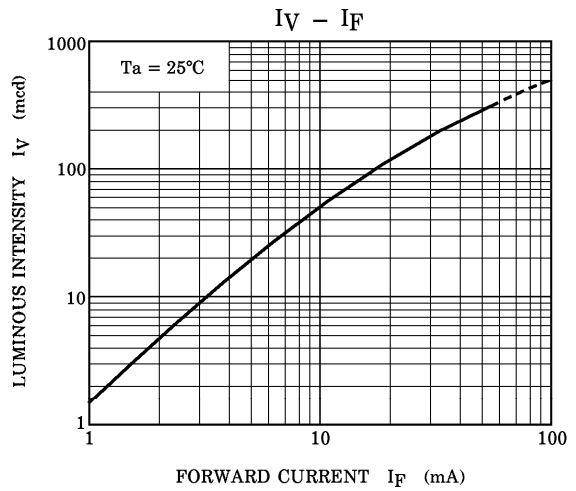
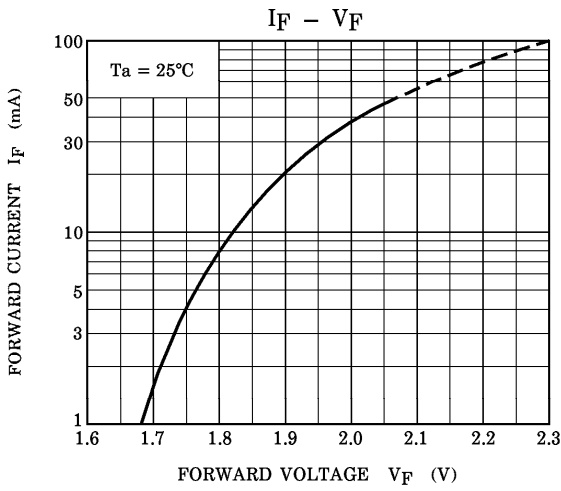

RADIATION PATTERN

$T_a = 25^\circ\text{C}$

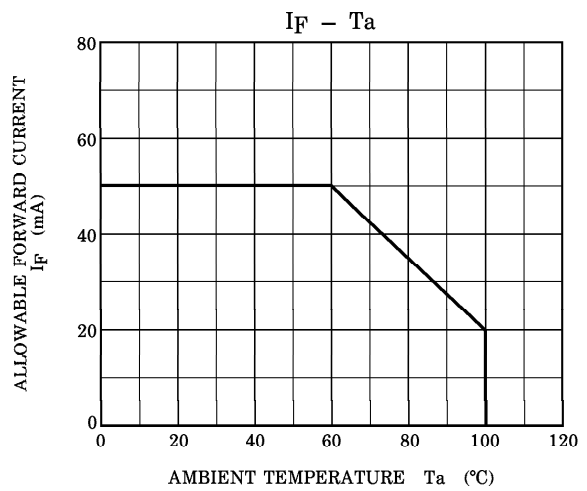
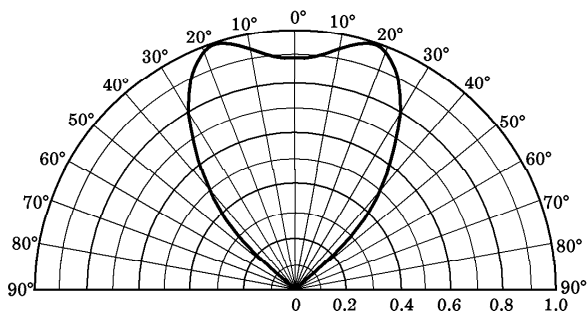

TLRME62T

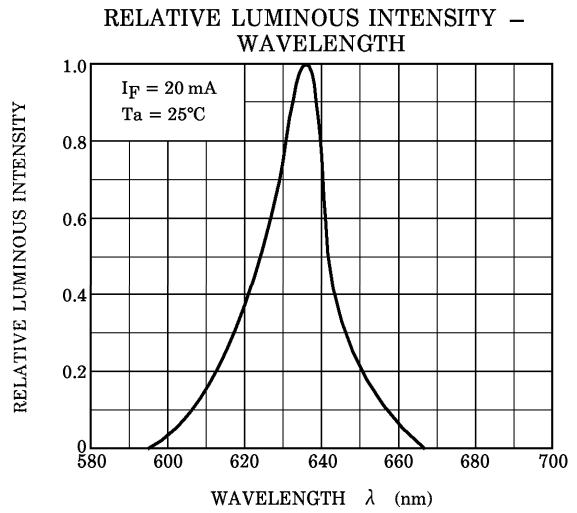
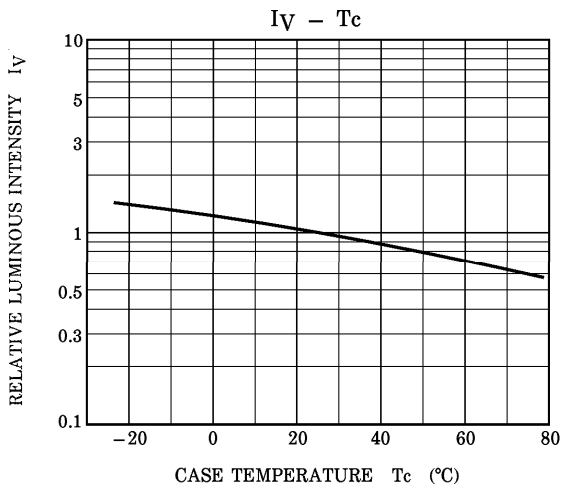
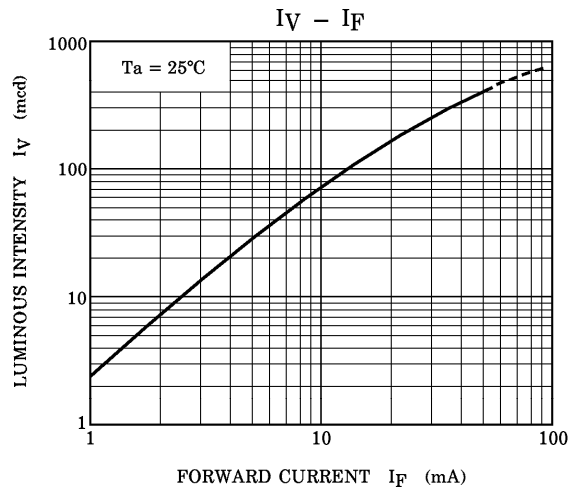
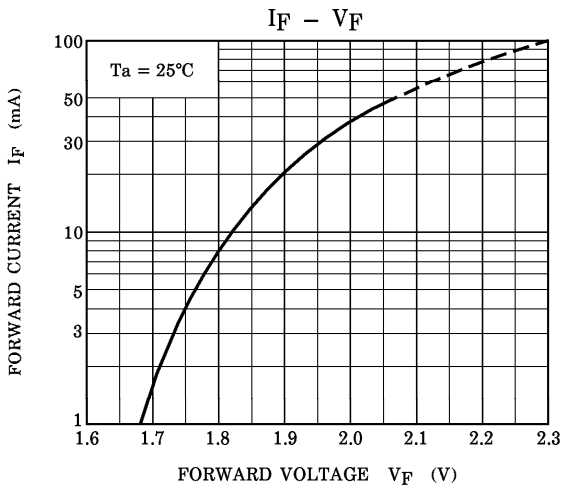

RADIATION PATTERN

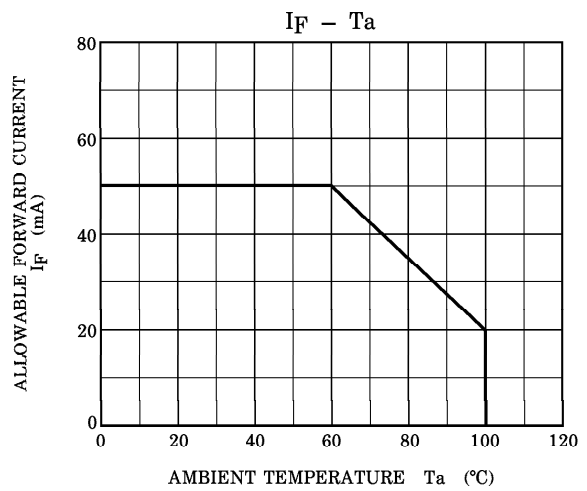
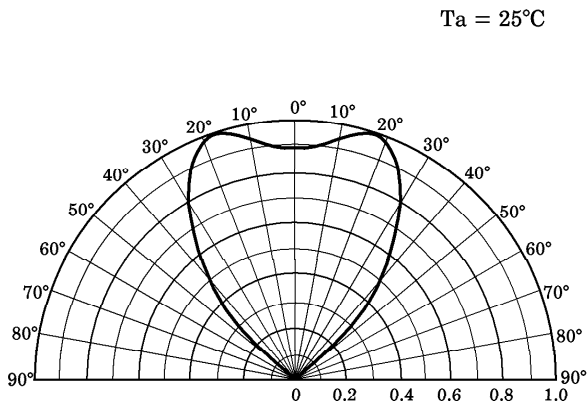

TLSE62T

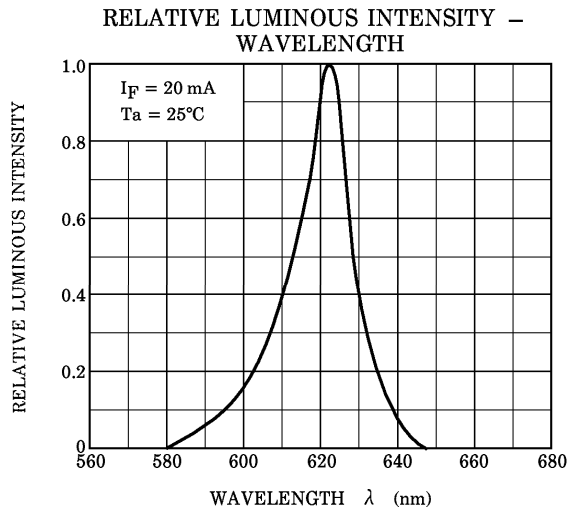
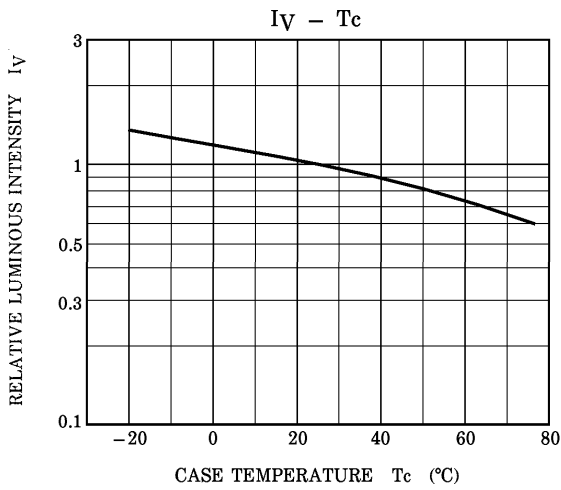
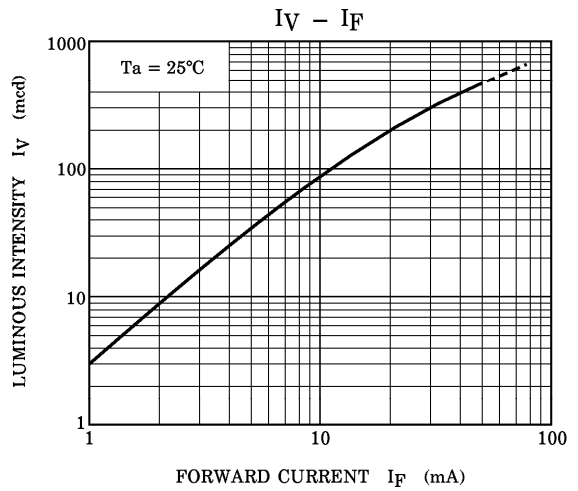
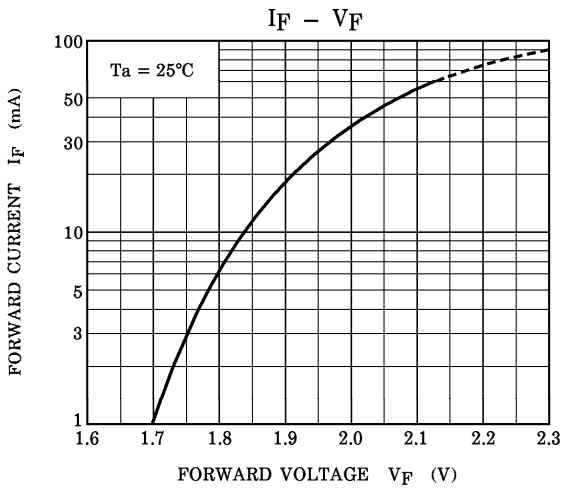

RADIATION PATTERN

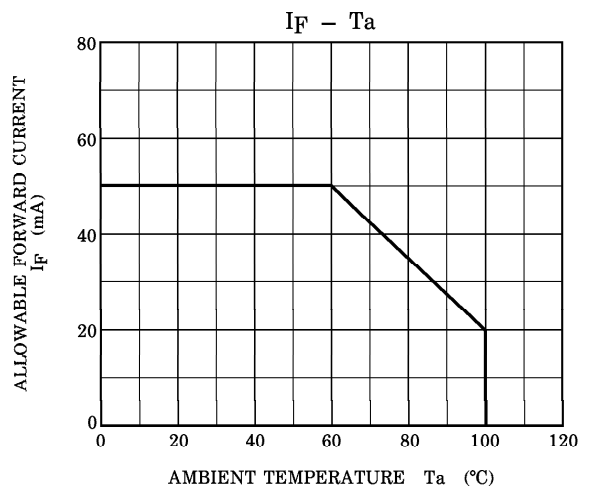
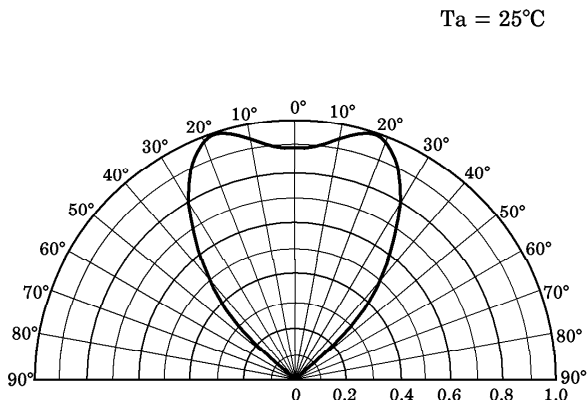

TLOE62T

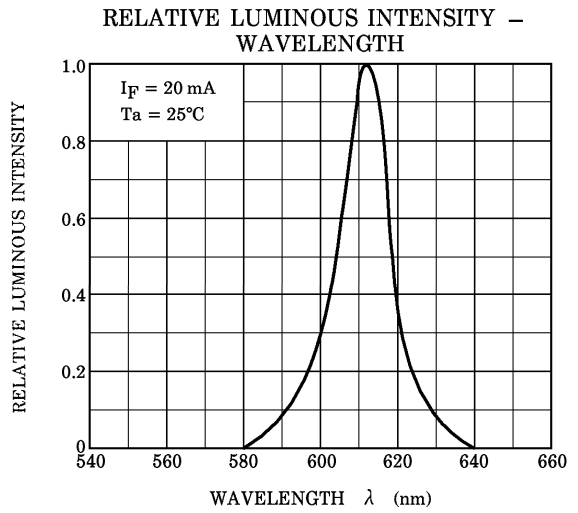
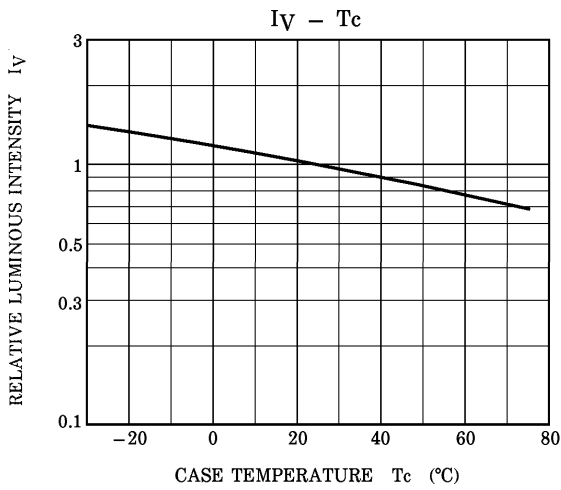
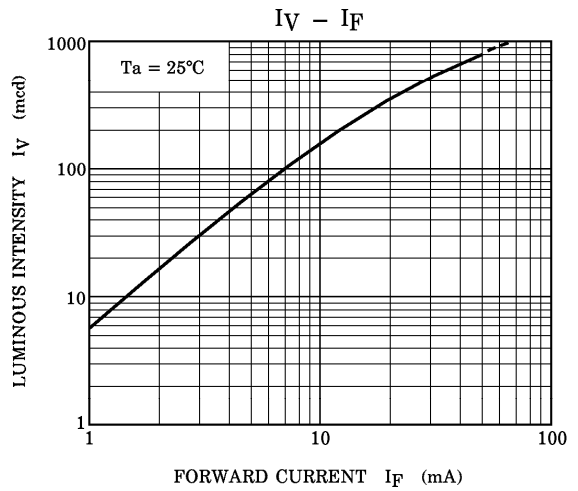
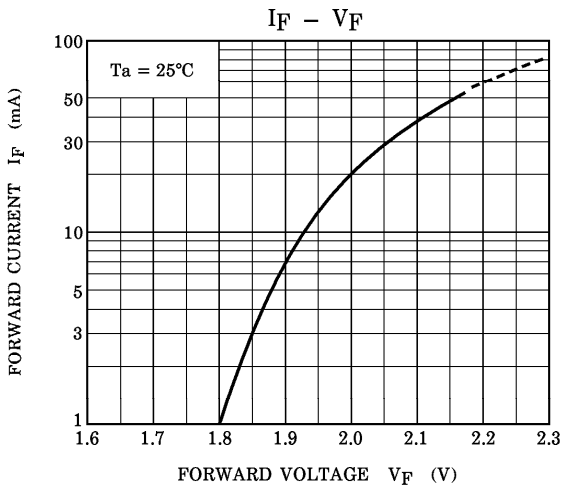

RADIATION PATTERN

$T_a = 25^\circ\text{C}$

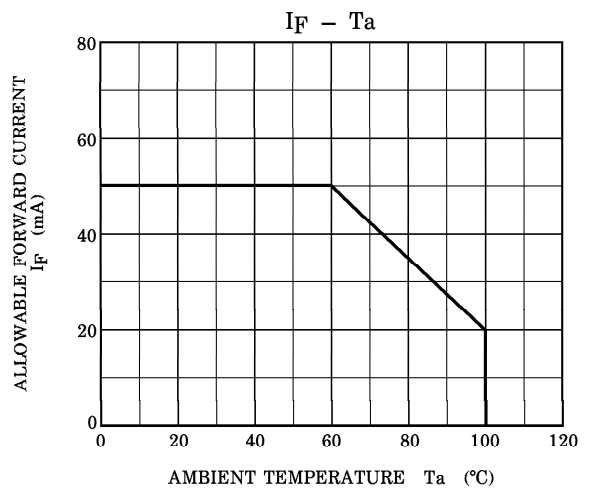
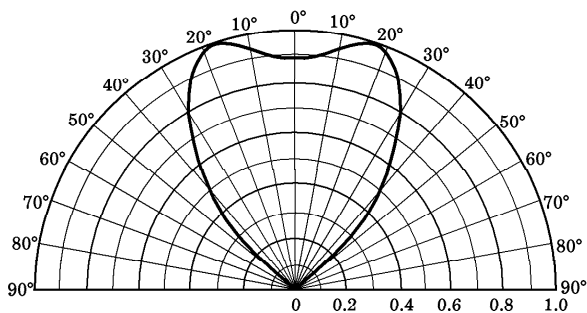

TLYE62T

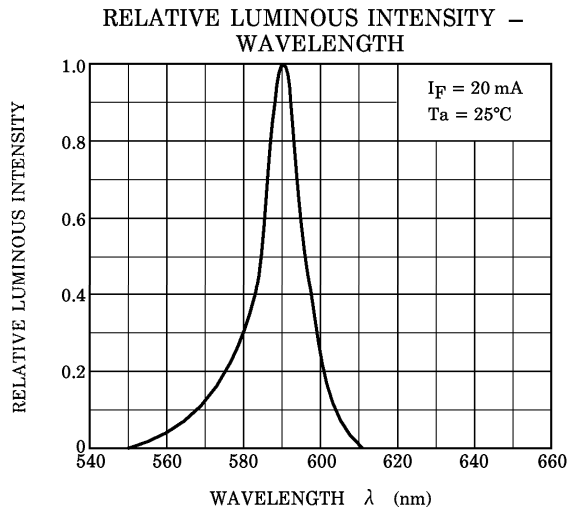
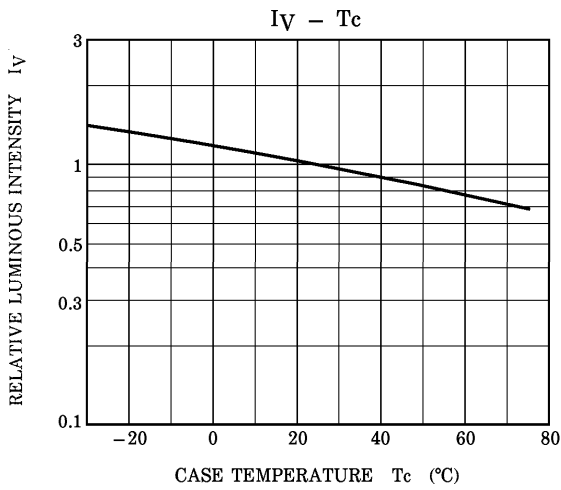
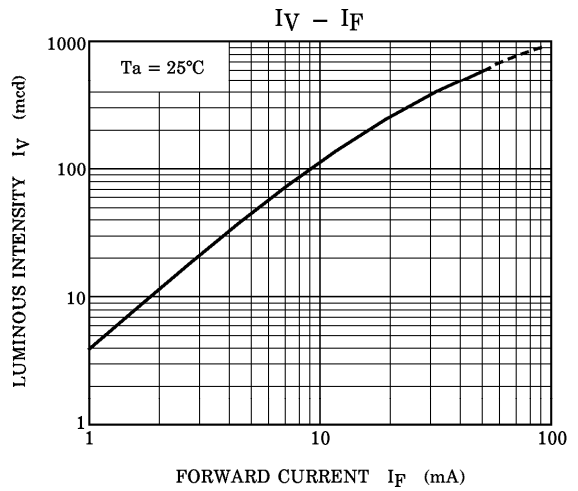
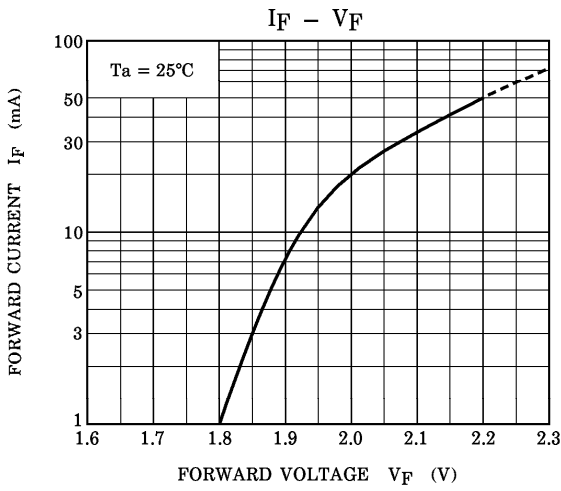

RADIATION PATTERN

$T_a = 25^\circ\text{C}$

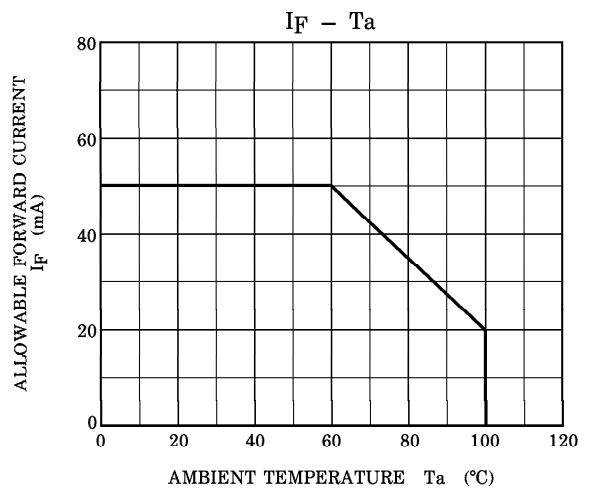
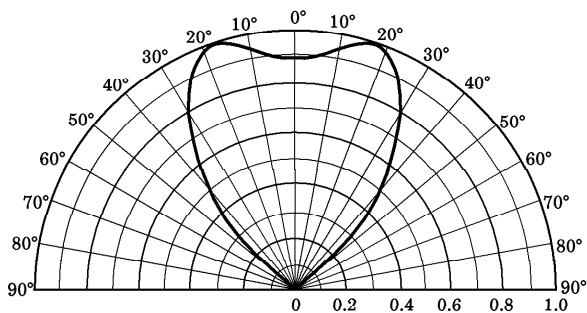

TLGE62T

$I_F - V_F$

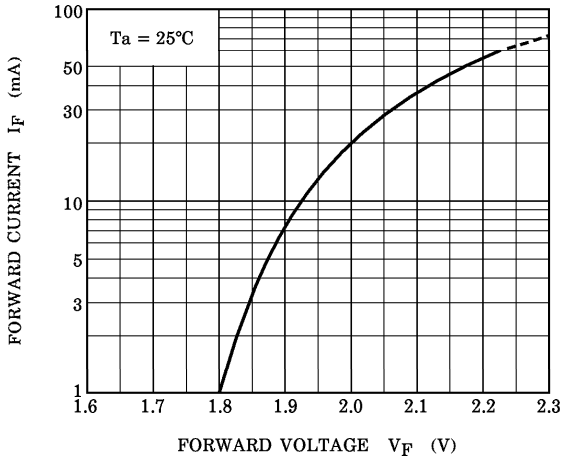

$I_V - I_F$

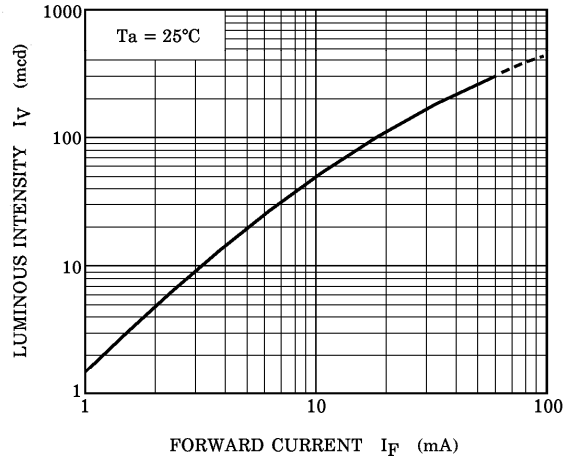

$I_V - T_c$

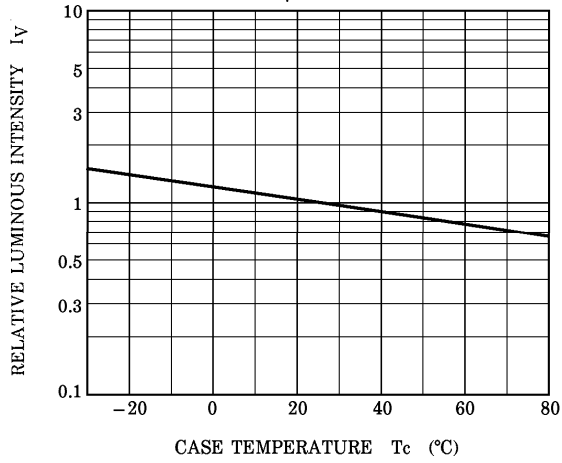

RELATIVE LUMINOUS INTENSITY - WAVELENGTH

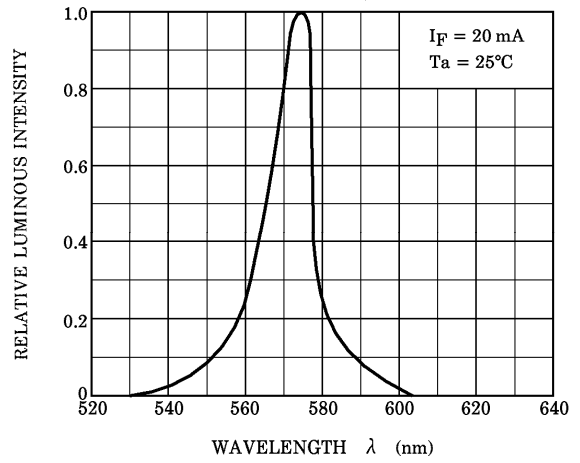

RADIATION PATTERN

$T_a = 25^\circ\text{C}$

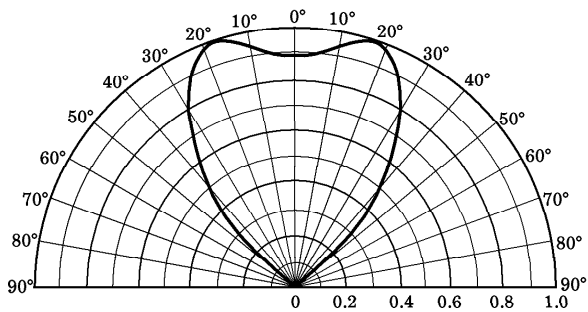

$I_F - T_a$

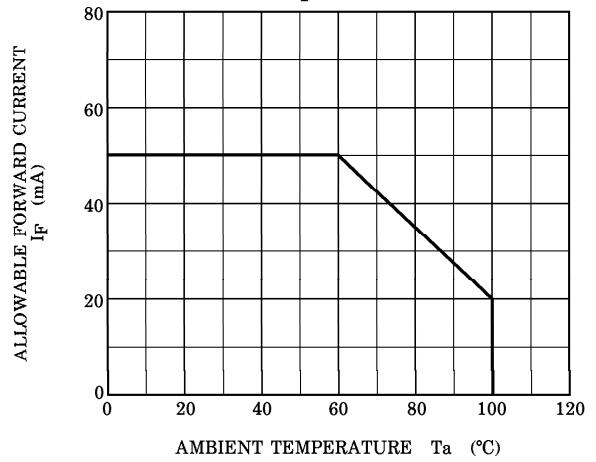

TLPGE62T

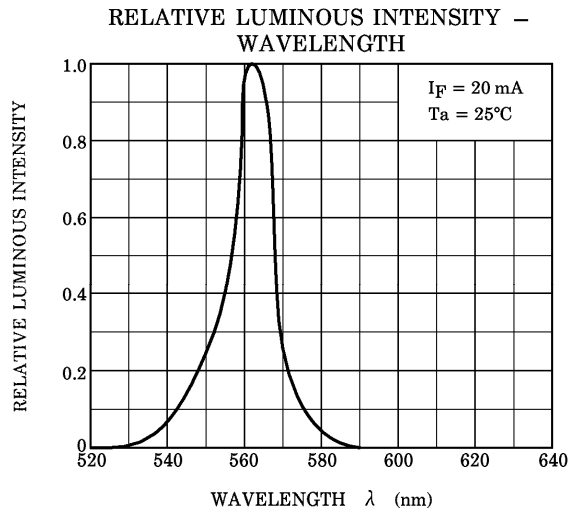
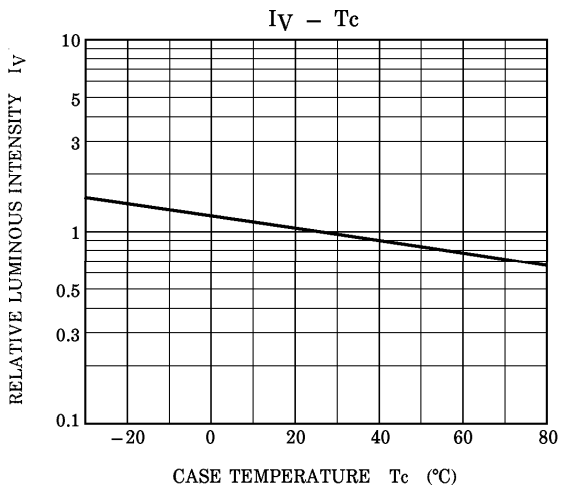
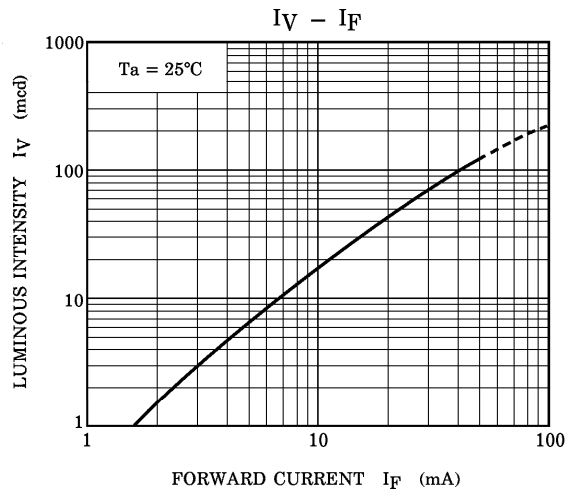
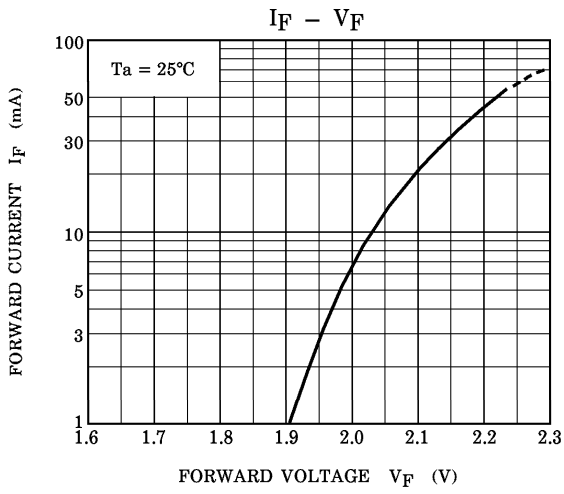

RADIATION PATTERN

