

FEATURES

- Maximum Initial Tolerance: 0.2%
- *Guaranteed* Temperature Stability
- Maximum 0.6Ω Dynamic Impedance
- Wide Operating Current Range
- Directly Interchangeable with LM136 for Improved Performance
- No Adjustments Needed for Minimum Temperature Coefficient

APPLICATIONS

- Reference for 5V Systems
- 8-Bit A/D and D/A Reference
- Digital Voltmeters
- Current Loop Measurement and Control Systems
- Power Supply Monitor

DESCRIPTION

The LT[®]1009 is a precision trimmed 2.5V shunt regulator diode featuring a maximum initial tolerance of only $\pm 5\text{mV}$. The low dynamic impedance and wide operating current range enhances its versatility. The 0.2% reference tolerance is achieved by on-chip trimming which not only minimizes the initial voltage tolerance but also minimizes the temperature drift.

Even though no adjustments are needed with the LT1009, a third terminal allows the reference voltage to be adjusted $\pm 5\%$ to calibrate out system errors. In many applications, the LT1009 can be used as a pin-to-pin replacement of the LM136 and the external trim network eliminated.

For a lower drift 2.5V reference, see the LT1019 data sheet.

 LTC and LT are registered trademarks of Linear Technology Corporation.

TYPICAL APPLICATION

2.5V Reference

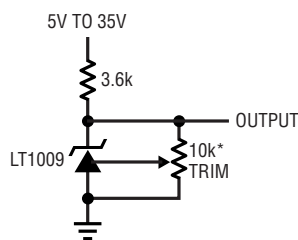

* DOES NOT AFFECT TEMPERATURE COEFFICIENT.
 $\pm 5\%$ TRIM RANGE

1009 TA01

Output Voltage

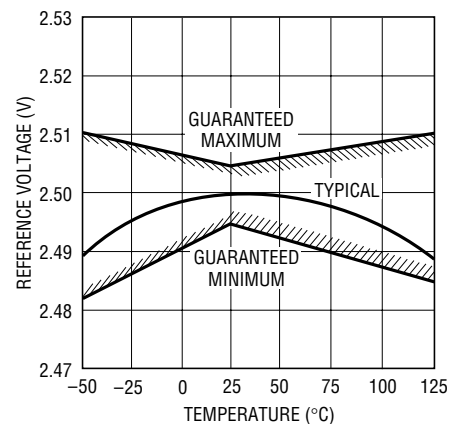

1009 TA02

LT1009 Series

ABSOLUTE MAXIMUM RATINGS (Note 1)

Reverse Current	20mA	Operating Temperature Range	
Forward Current	10mA	LT1009/LT1009C	0°C to 70°C
Storage Temperature Range	-65°C to 150°C	LT1009I	-40°C to 85°C
Lead Temperature (Soldering, 10 sec).....	300°C	LT1009M	-55°C to 125°C

PACKAGE/ORDER INFORMATION

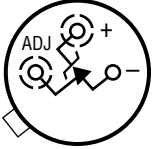
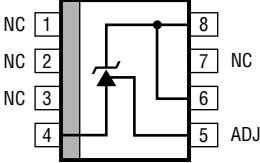
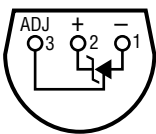
<p style="text-align: center;">BOTTOM VIEW</p>  <p style="text-align: center;">H PACKAGE 3-LEAD TO-46 METAL CAN</p> <p style="text-align: center;">$T_{JMAX} = 150^{\circ}C, \theta_{JA} = 440^{\circ}C/W, \theta_{JC} = 80^{\circ}C/W$</p>	<p style="text-align: center;">TOP VIEW</p>  <p style="text-align: center;">S8 PACKAGE 8-LEAD PLASTIC SO</p> <p style="text-align: center;">$T_{JMAX} = 150^{\circ}C, \theta_{JA} = 190^{\circ}C/W$</p>	<p style="text-align: center;">BOTTOM VIEW</p>  <p style="text-align: center;">Z PACKAGE 3-LEAD PLASTIC TO-92</p> <p style="text-align: center;">$T_{JMAX} = 100^{\circ}C, \theta_{JA} = 160^{\circ}C/W$</p>
ORDER PART NUMBER	ORDER PART NUMBER	ORDER PART NUMBER
LT1009MH LT1009CH	LT1009S8 LT1009IS8	LT1009CZ LT1009IZ
	S8 PART MARKING	
	1009 1009I	

AVAILABLE OPTIONS

TEMPERATURE	ACCURACY (%)	TEMPERATURE COEFFICIENT (ppm/°C)	PACKAGE STYLE		
			TO-46 (H)	SO-8 (S8)	TO-92 (Z)
0°C to 70°C	0.20 0.40	25 25	LT1009CH	LT1009S8	LT1009CZ
-40°C to 85°C	0.20 0.40	35 35		LT1009IS8	LT1009IZ
-55°C to 125°C	0.20	35	LT1009MH		

ELECTRICAL CHARACTERISTICS

The ● denotes specifications which apply over the full operating temperature range, otherwise specifications are $T_A = 25^\circ\text{C}$. For MIL-STD components, please refer to LTC883C data sheet for test listing and parameters.

SYMBOL	PARAMETER	CONDITIONS	LT1009M			LT1009I			LT1009/LT1009C			UNITS
			MIN	TYP	MAX	MIN	TYP	MAX	MIN	TYP	MAX	
V_Z	Reverse Breakdown Voltage	$T_A = 25^\circ\text{C}$, $I_R = 1\text{mA}$, H, Z Pkg S Pkg	2.495	2.500	2.505	2.495	2.500	2.505	2.495	2.500	2.505	V V
$\frac{\Delta V_Z}{\Delta I_R}$	Reverse Breakdown Change with Current	$400\mu\text{A} \leq I_R \leq 10\text{mA}$	●	2.6	6	●	2.6	10	●	2.6	10	mV mV
r_Z	Reverse Dynamic Impedance	$I_R = 1\text{mA}$	●	0.2	0.6	●	0.2	1.0	●	0.2	1.0	Ω Ω
	Temperature Stability	$T_{\text{MIN}} \leq T_A \leq T_{\text{MAX}}$	●		15	●		15	●	1.8	4	mV
$\frac{\Delta V_Z}{\Delta \text{Temp}}$	Average Temperature Coefficient (Notes 2, 3)	$0^\circ\text{C} \leq T_A \leq 70^\circ\text{C}$ $-40^\circ\text{C} \leq T_A \leq 85^\circ\text{C}$ $-55^\circ\text{C} \leq T_A \leq 125^\circ\text{C}$		15	25		15	25		15	25	ppm/ $^\circ\text{C}$ ppm/ $^\circ\text{C}$ ppm/ $^\circ\text{C}$
$\frac{\Delta V_Z}{\Delta \text{Time}}$	Long-Term Stability	$T_A = 25^\circ\text{C} \pm 0.1^\circ\text{C}$ $I_R = 1\text{mA}$		20			20			20		ppm/kHr

Note 1: Absolute Maximum Ratings are those values beyond which the life of a device may be impaired.

Note 2: Guaranteed by Design.

Note 3: Average temperature coefficient is defined as the total voltage change divided by the specified temperature change.

TYPICAL PERFORMANCE CHARACTERISTICS

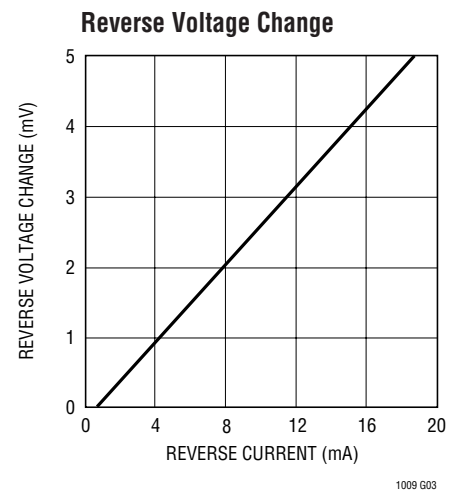
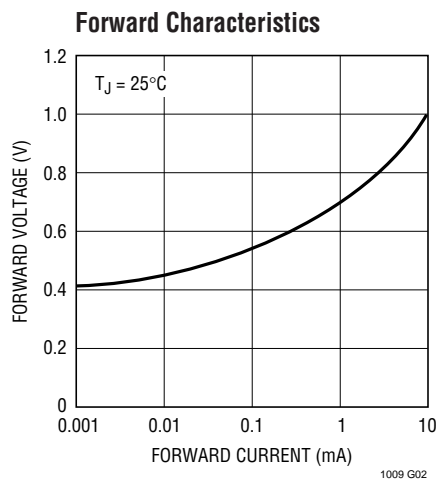
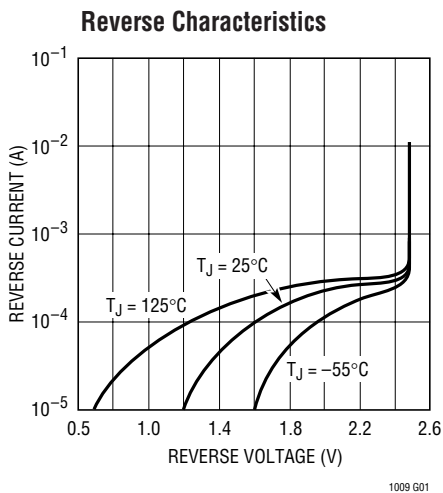

TYPICAL PERFORMANCE CHARACTERISTICS

Dynamic Impedance

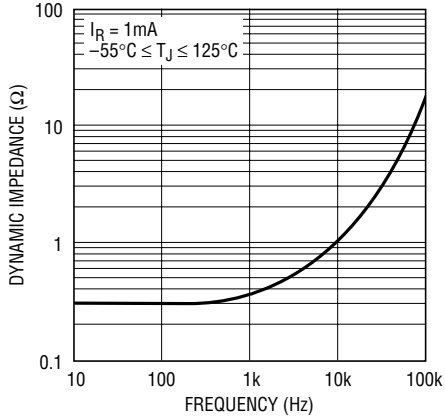

1009 G04

Output Noise Voltage

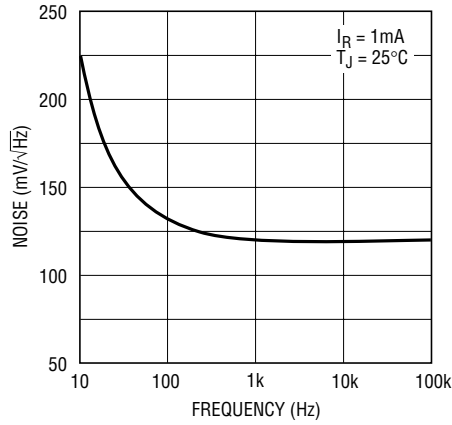

1009 G05

Response Time

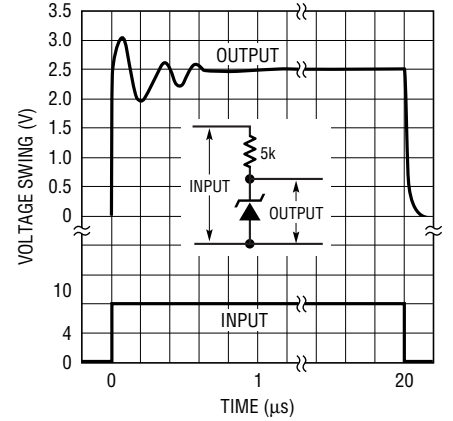

1009 G06

SCHEMATIC DIAGRAM

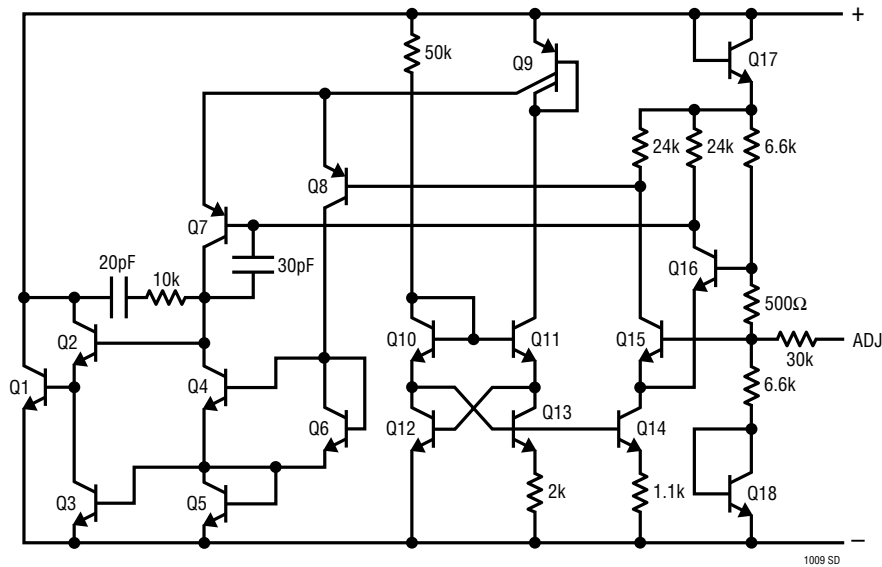

1009 SD

TYPICAL APPLICATIONS

Wide Supply Range, Adjustable Reference

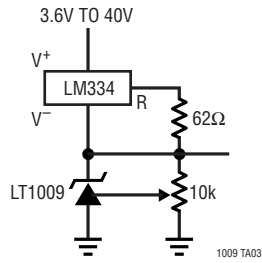

Low Temperature Coefficient Power Regulator

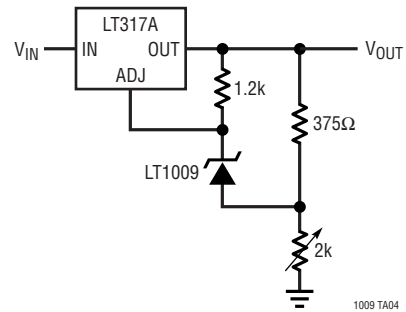

Switchable $\pm 1.25V$ Bipolar Reference

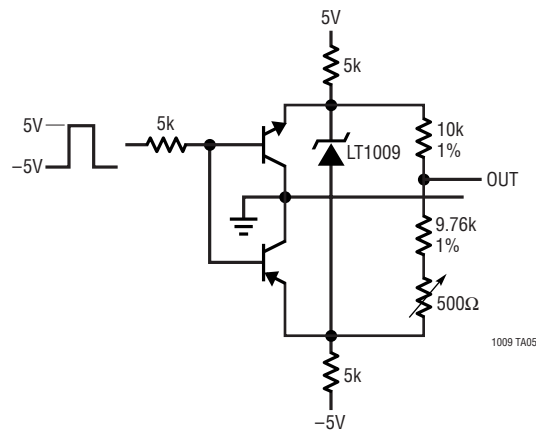

PACKAGE DESCRIPTION

Dimensions in inches (millimeters) unless otherwise noted.

H Package
2-Lead and 3-Lead TO-46 Metal Can
 (LTC DWG # 05-08-1340)

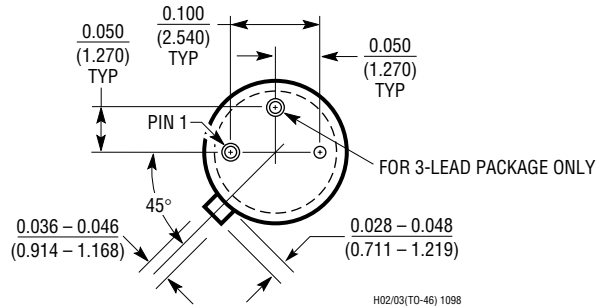
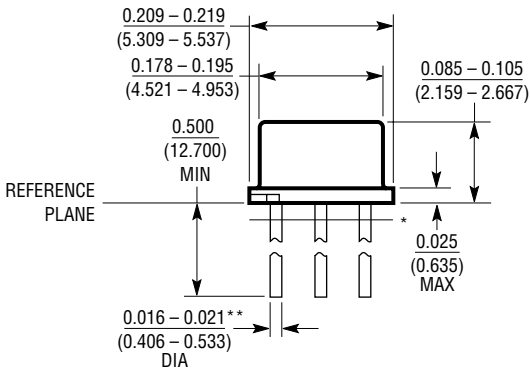

*LEAD DIAMETER IS UNCONTROLLED BETWEEN THE REFERENCE PLANE AND 0.045" BELOW THE REFERENCE PLANE
 **FOR SOLDER DIP LEAD FINISH, LEAD DIAMETER IS $\frac{0.016 - 0.024}{(0.406 - 0.610)}$

Z Package
3-Lead Plastic TO-92 (Similar to TO-226)
 (LTC DWG # 05-08-1410)

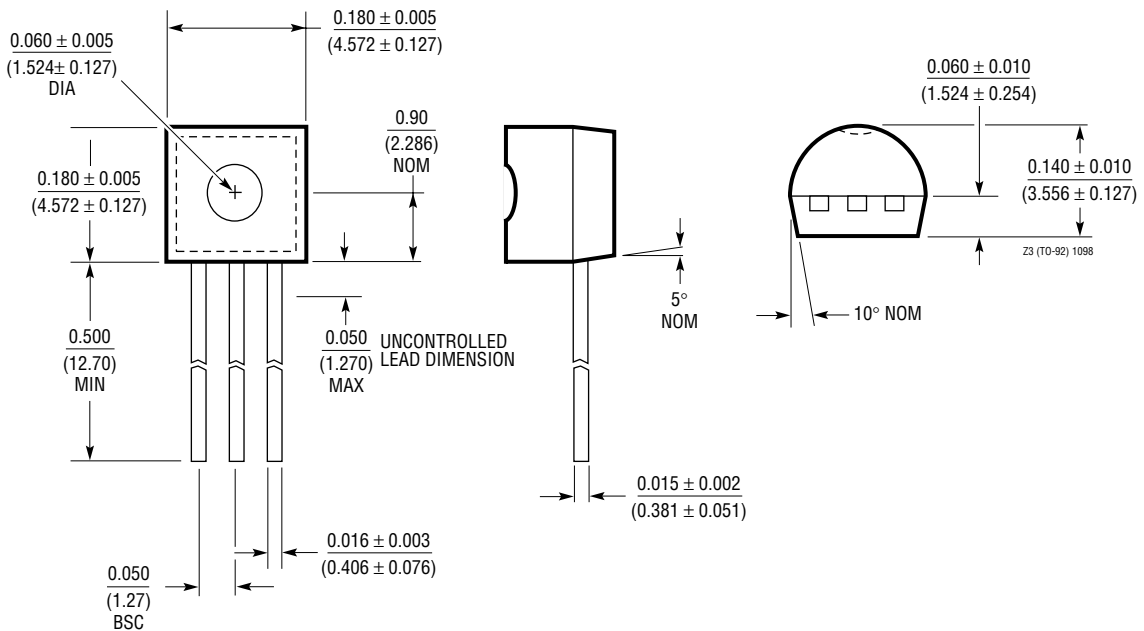

PACKAGE DESCRIPTION Dimensions in inches (millimeters) unless otherwise noted.

S8 Package
8-Lead Plastic Small Outline (Narrow 0.150)
 (LTC DWG # 05-08-1610)

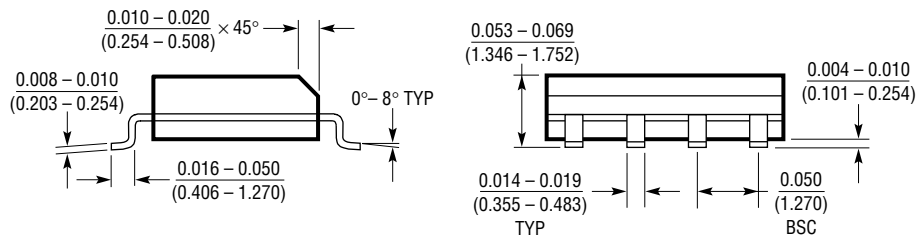
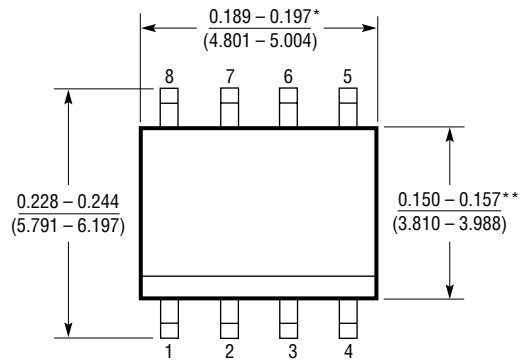

*DIMENSION DOES NOT INCLUDE MOLD FLASH. MOLD FLASH SHALL NOT EXCEED 0.006" (0.152mm) PER SIDE
 **DIMENSION DOES NOT INCLUDE INTERLEAD FLASH. INTERLEAD FLASH SHALL NOT EXCEED 0.010" (0.254mm) PER SIDE

S08 1298

TYPICAL APPLICATION

Low Noise 2.5V Buffered Reference

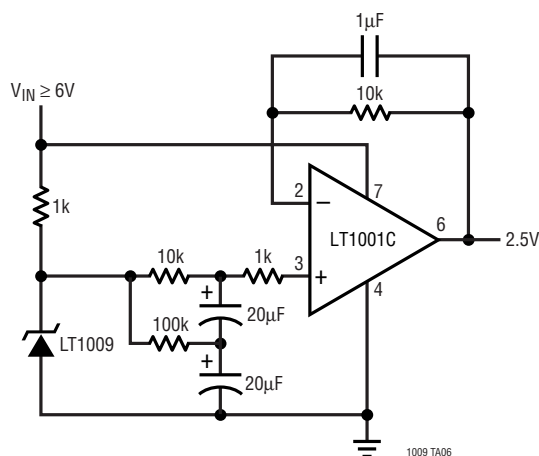

RELATED PARTS

PART NUMBER	DESCRIPTION	COMMENTS
LT1019	Precision Series Reference	Bandgap, 0.05%, 5ppm/°C
LT1236	Precision Series Reference	5V and 10V Zener-Based 5ppm/°C, SO-8 Package
LTC [®] 1798	Micropower Low Dropout Series Reference	0.15% Max, 6.5µA Supply Current
LT1460	Micropower Precision Series Reference	Bandgap, 130µA Supply Current 10ppm/°C, Available in SOT-23
LT1634	Micropower Precision Shunt Voltage Reference	Bandgap 0.05%, 10ppm/°C, 10µA Supply Current
LT1461	Micropower Precision Series Reference	0.04% Max, 3ppm/°C Max, 35µA Supply Current