

SANKEN DISCRETES

TRANSISTOR ARRAYS

Type No.	V _{CEO} (V)	I _{C(ICP)} (A)	h _{FE} min	Equivalent Circuit Diagram
STA301A	60±10	4(8)	1000	1
STA302A	-50	-4(-8)	1000	2
STA303A	100	4(8)	1000	3
STA304A	550	1(2)	200	4
STA305A	-550	-1(-2)	200	5
STA308A	-120	-4(-8)	2000	6
STA311A	50	3(5)	70	7
STA312A	60	3(6)	300	7
STA321A	-60	-3(-6)	40	8
STA322A	-50	-3(-5)	100	8
STA341M	30	1	100	9
	-30	-1	100	
STA342M	30	1	100	10
STA401A	60±10	4(8)	1000	11
STA402A	-50	-4(-8)	1000	12
STA403A	100	4(8)	1000	13
STA404A	200	3(6)	1000	13
STA405A	80	4(8)	1000	13
STA406A	60±10	6	2000	11
STA407A	100±15	4(8)	2000	11
STA408A	-120	-4(-8)	2000	14
STA411A	60	3(6)	40	15
STA412A	60	3(6)	300	15
STA413A	35±5	3(6)	500	16
STA414A	(V _{CEB})100	5(8)	200	17
STA421A	-60	-3(-6)	40	18
STA431A	60	3(6)	40	19
	-60	-3(-6)	40	
STA432A	60±10	4(8)	1000	20
	-60	-3(-6)	40	
STA433A	100	4(8)	1000	21
STA434A	60	4(8)	1000	22
	-60	-4(-8)	1000	
STA435A	65±15	4(8)	1000	23
STA437A	-50	-4(-8)	1000	14
STA438A	200	3(6)	1000	21
STA439A	60±10	6	2000	23
STA441C	160	1.5(3)	40	24
STA451C	60	3(6)	40	25
	-60	-3(-6)	40	
STA455C	35	7(12)	80	26
	-35	-7(-12)	80	
STA457C	60	4(8)	2000	27
	-60	-4(-8)	2000	
STA458C	30	5(10)	40	28
	-30	-5(-10)	40	
STA460C	60±10	±6(±10)	700	29
STA471A	60±10	2(4)	2000	11
STA472A	-60	-2(-4)	2000	12
STA473A	100	2(4)	2000	13
STA475A	100±15	2(4)	2000	11

Type No.	V _{CEO} (V)	I _{C(ICP)} (A)	h _{FE} min	Equivalent Circuit Diagram
SMA4020	-60	-4	2000	30
SMA4021	-60	-3(-6)	2000	31
SMA4030	100	3(5)	2000	32
SMA4031	100	3(5)	2000	33
SMA4032	100	3(5)	2000	33
SMA4033	100	2(4)	2000	33
SMA4121	50	3	500	34
SMA6010	60	4(6)	2000	35
	-60	-4(-6)	2000	
SMA6012	60	4(6)	2000	36
	-60	-4(-6)	2000	
SMA6040	30	2(4)	2000	37
	-30	-2(-4)	70	
SMA6511	100±15	1.5	2000	38
	-50	-3	2000	
SMA6512	60±10	1.5	2000	38
	-50	-3	2000	

SANKEN DISCRETES TRANSISTOR ARRAYS

TRANSISTOR ARRAYS

Type No.	V _{CEO} (V)	I _{C(I_{CP})} (A)	h _{FE} min	Equivalent Circuit Diagram
SLA4010	60±10	4(6)	2000	39
SLA4020	-60	-4(-6)	2000	40
SLA4030	100	4(6)	2000	41
SLA4031	120	4(6)	2000	42
SLA4041	200	3(6)	1000	42
SLA4060	120	5(8)	2000	41
SLA4061	120	5(8)	2000	42
SLA4070	-100	-5(-8)	1000	40
SLA4071	-100	-5(-8)	1000	43
SLA4310	60	4(6)	80	44
	-60	-4(-6)	80	
SLA4312	60	4(6)	40	45
	-60	-4(-6)	40	
SLA4313	35	5(8)	50	46
	-35	-5(-8)	50	
SLA4340	60	4(6)	2000	47
	-60	-4(-6)	2000	
SLA4342	60	4(6)	2000	48
	-60	-4(-6)	2000	
SLA4390	100	5(8)	2000	47
	-100	-5(-8)	2000	
SLA4391	100	5(8)	1000	49
	-100	-5(-8)	1000	
SLA4392	100	5(8)	1000	50
	-100	-5(-8)	1000	
SLA6010	60	4(6)	2000	51
	-60	-4(-6)	2000	
SLA6012	60	4	2000	52
	-60	-4	2000	
SLA6020	100	5(8)	2000	51
	-100	-5(-8)	2000	
SLA6022	80	5(8)	2000	52
	-100	-5(-8)	2000	
SLA6023	60	6(12)	2000	52
	-60	-6(-12)	2000	
SLA6030	35	4(6)	70	53
	-35	-4(-6)	70	
SLA6050	100	5	2000	51
	-60	-4	2000	
SLA8001	60	12	50	54
	-60	-12	50	
SLA1008	120 (V _R)	(I ₀) 0.7		55

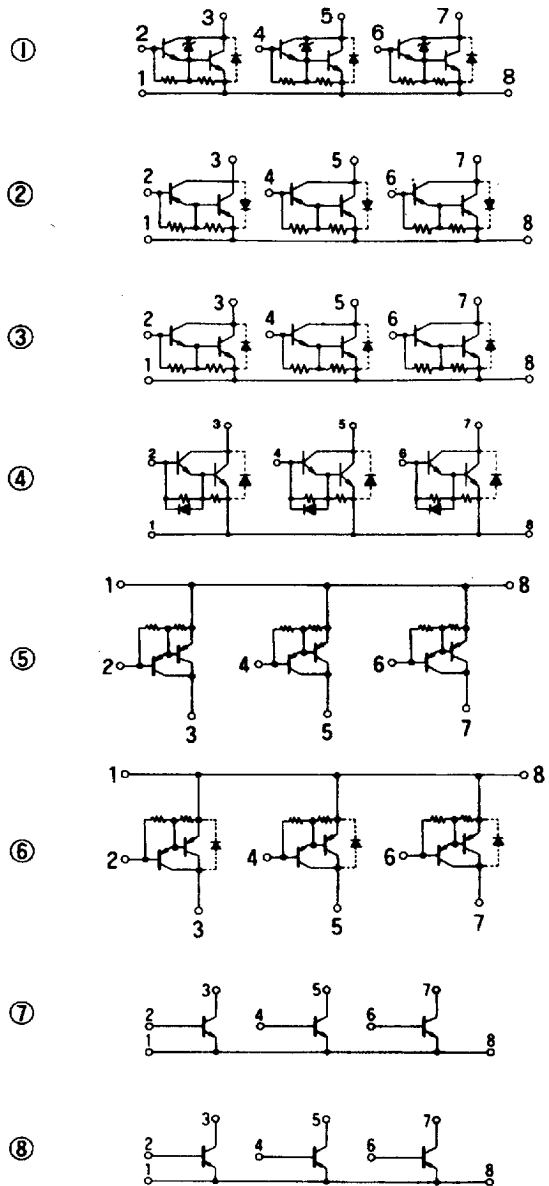

0504338 0007394 917

SANKEN DISCRETES TRANSISTOR ARRAYS

⑨

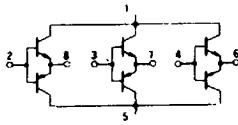

⑩

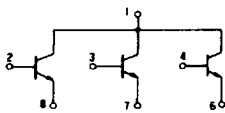

⑪

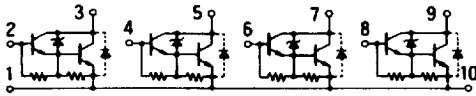

⑫

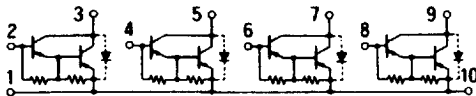

⑬

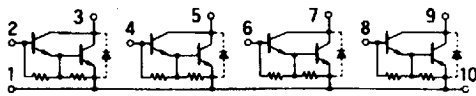

⑭

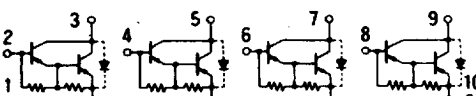

⑮

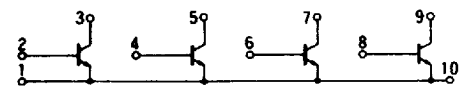

⑯

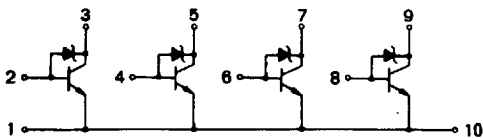

⑰

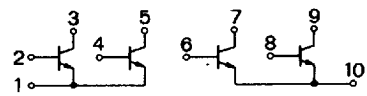

⑱

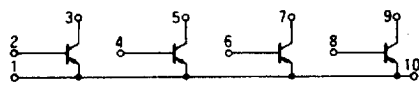

⑲

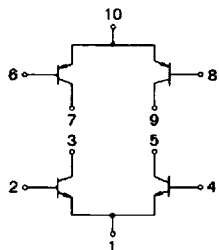

⑳

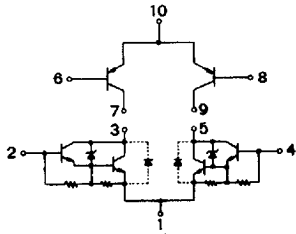

㉑

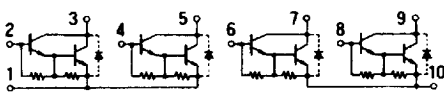

㉒

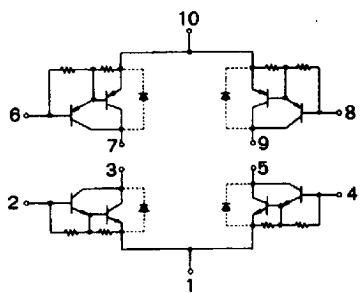

SANKEN DISCRETES TRANSISTOR ARRAYS

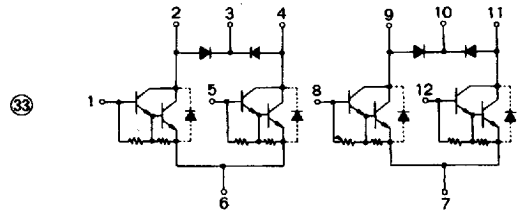
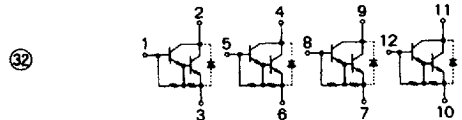
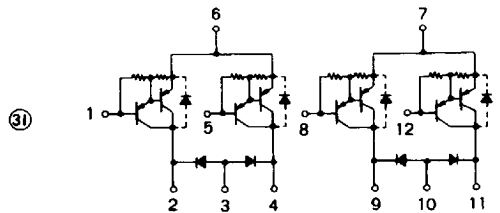
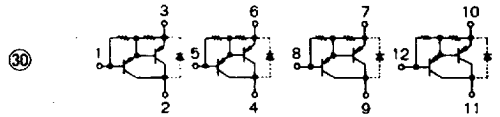
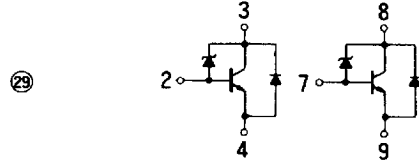
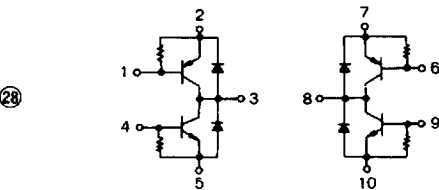
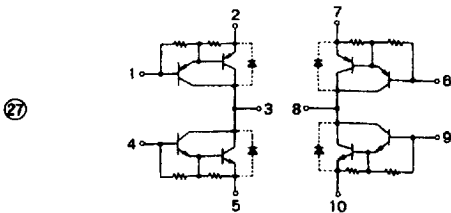
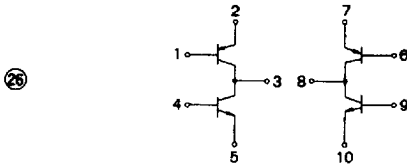
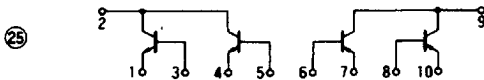
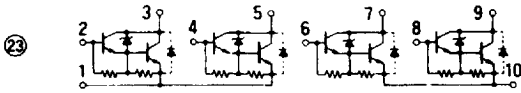

0504338 0007396 79T

SANKEN DISCRETES TRANSISTOR ARRAYS

34

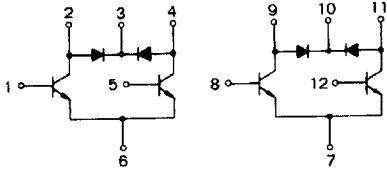

35

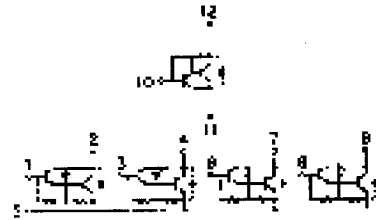

36

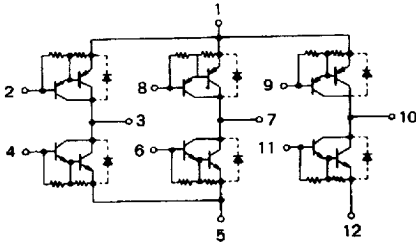

38

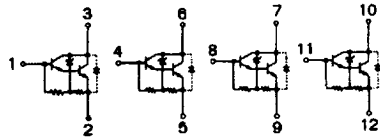

40

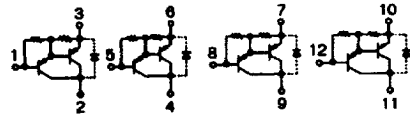

37

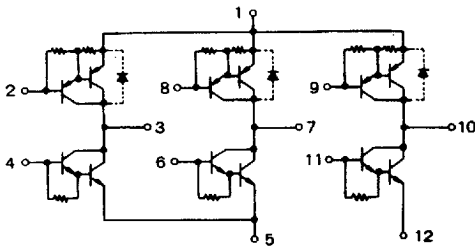

41

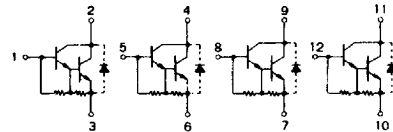

42

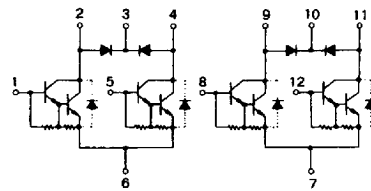

SANKEN DISCRETES TRANSISTOR ARRAYS

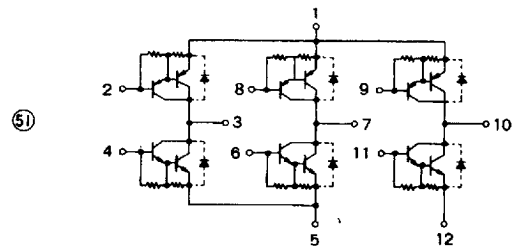
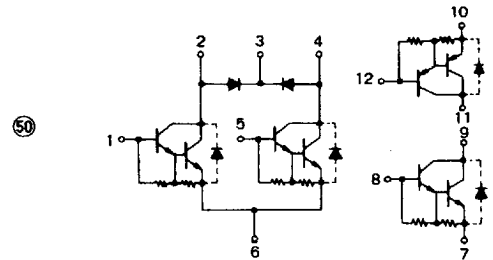
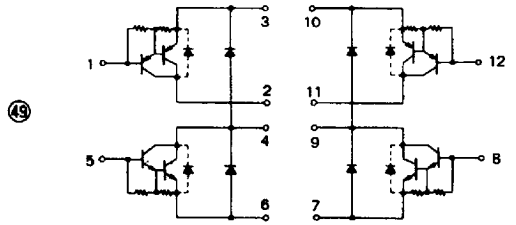
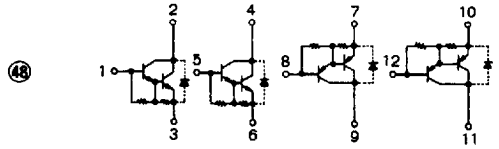
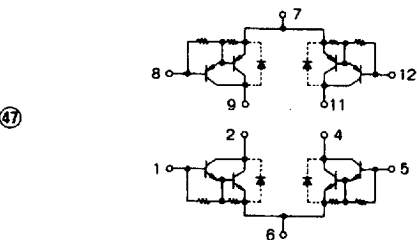
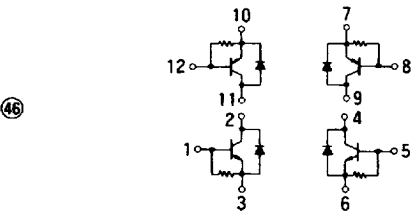
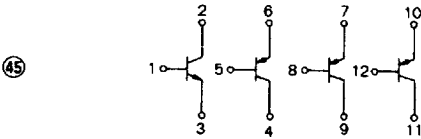
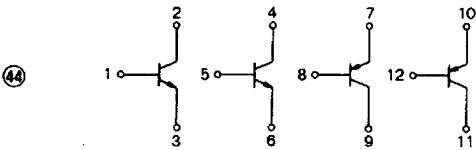
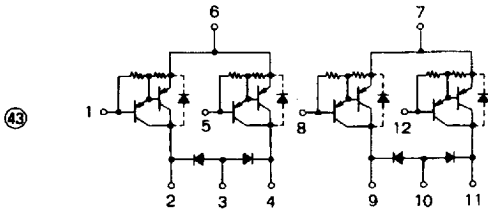

0504338 0007398 562

SANKEN DISCRETES TRANSISTOR ARRAYS

50

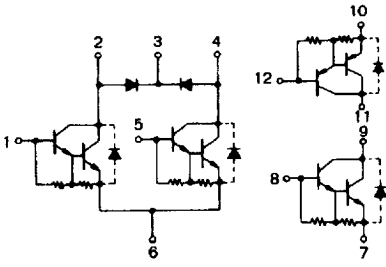

53

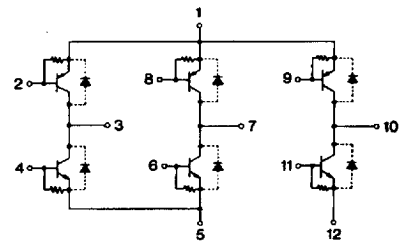

51

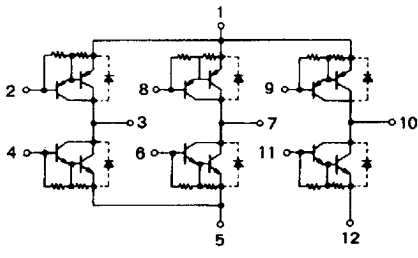

54

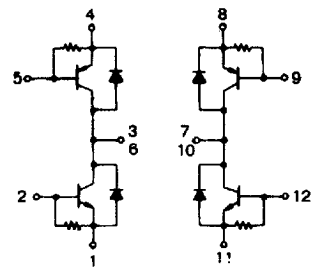

52

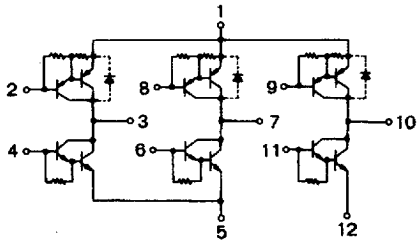

55

