

**LC78622NE****Compact Disc Player DSP****Overview**

The LC78622NE is a CMOS IC that implements the signal processing and servo control required by compact disc players. At the same time as providing an EFM PLL circuit, a 1-bit D/A converter, and an analog low-pass filter the LC78622NE realizes an optimal cost-performance tradeoff for low-end players by strictly limiting functionality to basic signal-processing and servo system functionality. The LC78622NE signal-processing system provides demodulation of the EFM signal from the pickup, de-interleaving, error detection and correction, and digital filters that can prove useful in reducing the cost of end products. The LC78622NE servo control system processes servo commands sent from the control microprocessor.

The LC78622NE is an improved version of the LC78622E that adds 8× oversampling digital filters, three general-purpose output ports (that also have specific shared functions) and the PCCL pin (pin 34). However, some handling of general-purpose ports differ from that of the LC78622E, therefore care must be taken. (Refer to pages 16 and 21).

Functions

- Input signal processing: The LC78622NE takes an HF signal as input, digitizes (slices) that signal at a precise level, converts that signal to an EFM signal, and generates a PLL clock with an average frequency of 4.3218 MHz by comparing the phases of that signal and an internal VCO.
- Precise reference clock and necessary internal timing generation using an external 16.9344 MHz crystal oscillator
- Disk motor speed control using a frame phase difference signal generated from the playback clock and the reference clock
- Frame synchronization signal detection, protection and interpolation to assure stable data readout
- EFM signal demodulation and conversion to 8-bit symbol data
- Subcode data separation from the EFM demodulated signal and output of that data to an external microprocessor
- Subcode Q signal output to a microprocessor over the serial I/O interface after performing a CRC error check (LSB first)
- Demodulated EFM signal buffering in internal RAM to handle up to ±4 frames of disk rotational jitter
- Demodulated EFM signal reordering in the prescribed order for data unscrambling and de-interleaving
- Error detection, correction, and flag processing (error correction scheme: dual C1 plus dual C2 correction)
- Sets the C2 flags based on the C1 flags and a C2 check, and then performs signal interpolation or muting depending on the C2 flags. The interpolation circuit uses a dual-interpolation scheme. The previous value is held if the C2 flags indicate errors two or more times consecutively.
- Support for command input from a control microprocessor: commands include track jump, focus start, disk motor start/stop, muting on/off and track count (8 bit serial input)
- Built-in digital output circuits.
- Arbitrary track counting to support high-speed data access
- D/A converter outputs with data continuity improved by 8× oversampling digital filters.
- Built-in third-order $\Sigma\Delta$ D/A converters (An analog low-pass filter is built in.)

■ Any and all SANYO products described or contained herein do not have specifications that can handle applications that require extremely high levels of reliability, such as life-support systems, aircraft's control systems, or other applications whose failure can be reasonably expected to result in serious physical and/or material damage. Consult with your SANYO representative nearest you before using any SANYO products described or contained herein in such applications.

■ SANYO assumes no responsibility for equipment failures that result from using products at values that exceed, even momentarily, rated values (such as maximum ratings, operating condition ranges, or other parameters) listed in products specifications of any and all SANYO products described or contained herein.

SANYO Electric Co., Ltd. Semiconductor Business Headquarters

TOKYO OFFICE Tokyo Bldg., 1-10, 1 Chome, Ueno, Taito-ku, TOKYO, 110-8534 JAPAN

11999RM (OT) No. 6015-1/31

7997076 0021751 582

LC78622NE

- Built-in digital attenuator (8 bits – alpha, 239 steps)
- Built-in digital de-emphasis
- Zero cross muting
- Supports the implementation of a double-speed dubbing function.
- Support for bilingual applications.
- General-purpose I/O ports: 5 pins

Features

- 5 V single-voltage power supply

Package Dimensions

unit: mm

3159-QFP64E

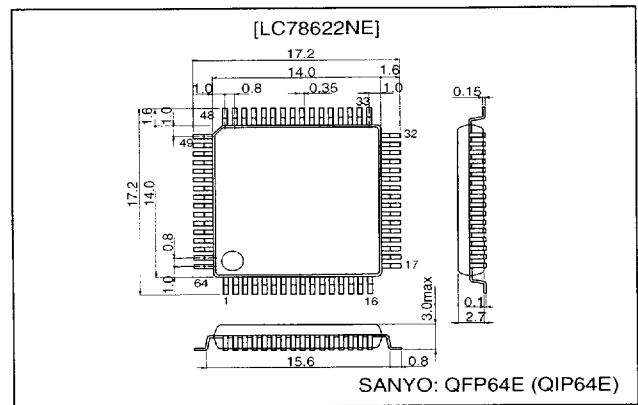

Equivalent Circuit Block Diagram

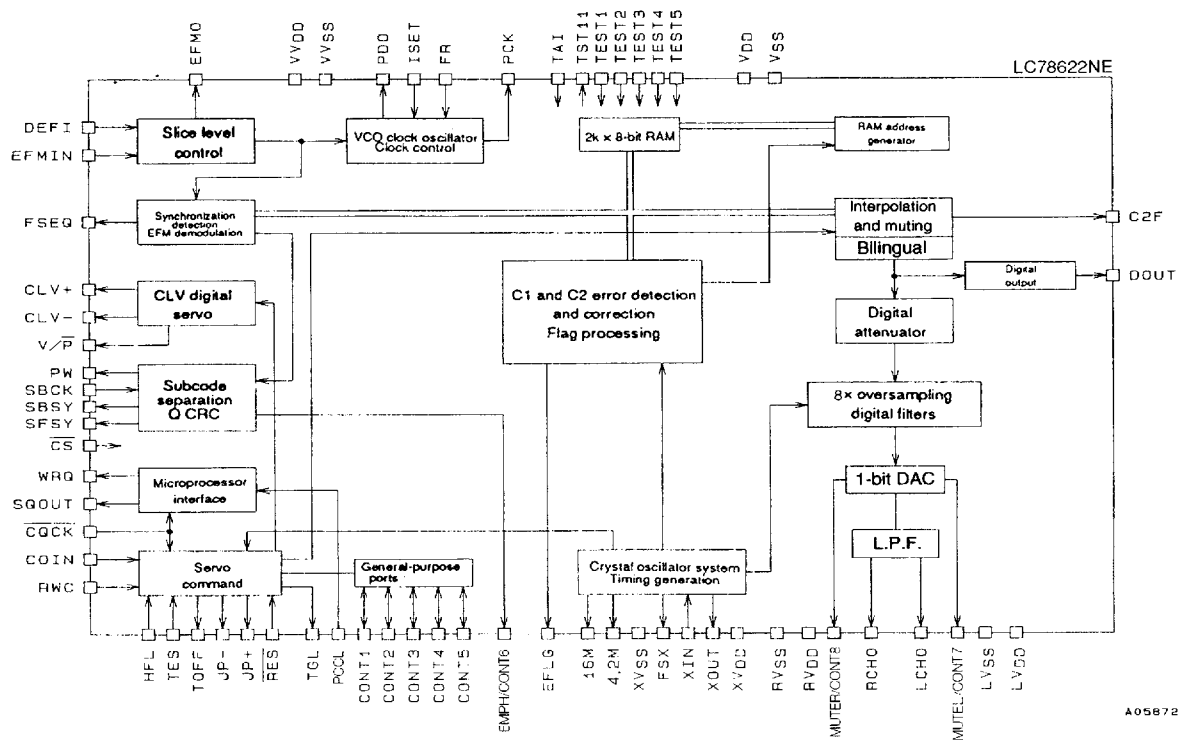

A05872

7997076 0021752 419

LC78622NE

Pin Assignment

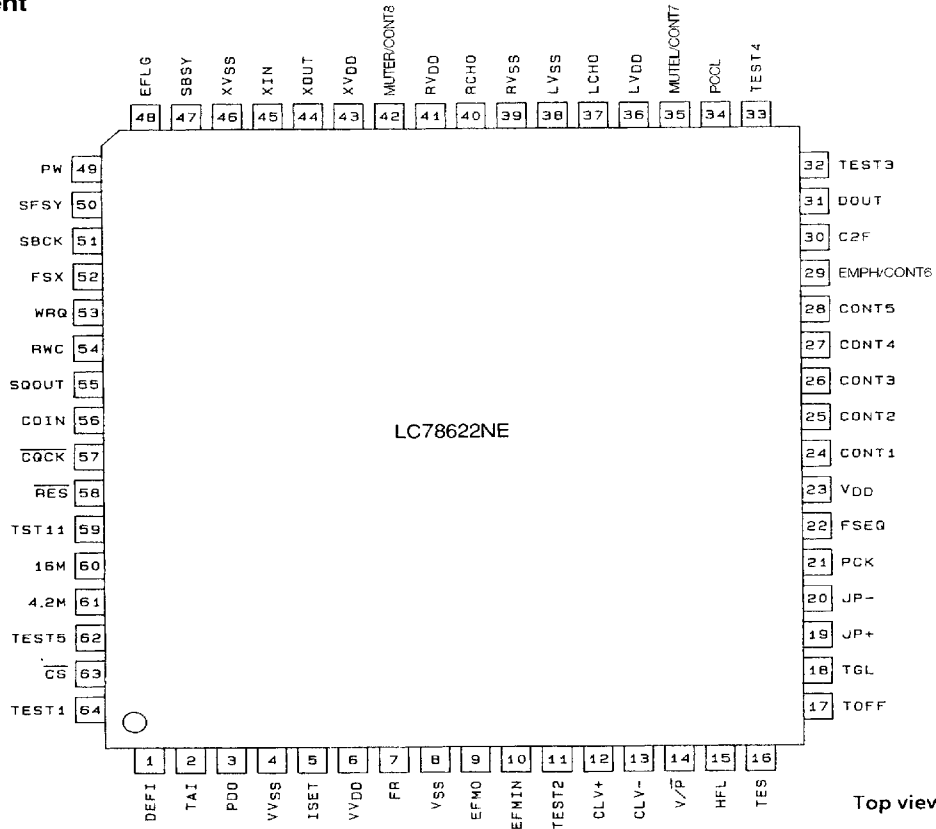

Specifications

Absolute Maximum Ratings at $T_a = 25^\circ\text{C}$, $V_{SS} = 0\text{ V}$

Parameter	Symbol	Conditions	Ratings	Unit
Maximum supply voltage	$V_{DD\text{ max}}$		$V_{SS} - 0.3$ to $V_{SS} + 7.0$	V
Input voltage	V_{IN}		$V_{SS} - 0.3$ to $V_{DD} + 0.3$	V
Output voltage	V_{OUT}		$V_{SS} - 0.3$ to $V_{DD} + 0.3$	V
Allowable power dissipation	$P_d\text{ max}$		300	mW
Operating temperature	T_{opr}		-20 to +75	$^\circ\text{C}$
Storage temperature	T_{stg}		-40 to +125	$^\circ\text{C}$

LC78622NE

Allowable Operating Ranges at Ta = 25°C, VSS = 0 V

Parameter	Symbol	Conditions	min	typ	max	Unit
Supply voltage	V _{DD} (1)	V _{DD} , XV _{DD} , LV _{DD} , RV _{DD} , VV _{DD} : During normal-speed playback	3.6		5.5	V
	V _{DD} (2)	V _{DD} , XV _{DD} , LV _{DD} , RV _{DD} , VV _{DD} : During double-speed playback	3.6		5.5	V
Input high level voltage	V _{IH} (1)	DEFI, COIN, RES, HFL, TES, SBCK, RWC, CQCK, TAI, TEST1 to TEST5, CS, CONT1 to CONT5, PCCL	0.7 V _{DD}		V _{DD}	V
	V _{IH} (2)	EFMIN	0.6 V _{DD}		V _{DD}	V
Input low level voltage	V _{IL} (1)	DEFI, COIN, RES, HFL, TES, SBCK, RWC, CQCK, TAI, TEST1 to TEST5, CS, CONT1 to CONT5, PCCL	0		0.3 V _{DD}	V
	V _{IL} (2)	EFMIN	0		0.4 V _{DD}	V
Data setup time	t _{SU}	COIN, RWC: Figure 1	400			ns
Data hold time	t _{HD}	COIN, RWC: Figure 1	400			ns
High level clock pulse width	t _{WH}	SBCK, CQCK: Figures 1, 2 and 3	400			ns
Low level clock pulse width	t _{WL}	SBCK, CQCK: Figures 1, 2 and 3	400			ns
Data read access time	t _{RAC}	SQOUT, PW: Figures 2 and 3	0		400	ns
Command transfer time	t _{RWC}	RWC: Figure 1	1000			ns
Subcode Q read enable time	t _{SQE}	WRQ: Figure 2, with no RWC signal		11.2		ms
Subcode read cycle time	t _{SC}	SFSY: Figure 3		136		μs
Subcode read enable time	t _{SE}	SFSY: Figure 3	400			ns
Port input data setup time	t _{CSU}	CONT1 to CONT5, RWC: Figure 4	400			ns
Port input data hold time	t _{CHD}	CONT1 to CONT5, RWC: Figure 4	400			ns
Port input clock setup time	t _{RCQ}	RWC, CQCK: Figure 4	100			ns
Port output data delay time	t _{CDD}	CONT1 to CONT8, RWC: Figure 5			1200	ns
Input level	V _{IN} (1)	EFMIN: Slice level control	1.0			Vp-p
	V _{IN} (2)	X _{IN} : Capacitor-coupled input	1.0			Vp-p
Operating frequency range	f _{OP}	EFMIN			10	MHz
Crystal oscillator frequency	f _X	X _{IN} , X _{OUT}		16.9344		MHz

Electrical Characteristics at Ta = 25°C, V_{DD} = 5 V, V_{SS} = 0 V

Parameter	Symbol	Conditions	min	typ	max	Unit
Current drain	I _{DD}	V _{DD} , XV _{DD} , LV _{DD} , RV _{DD} , VV _{DD}		25	35	mA
Input high level current	I _{IH} (1)	DEFI, EFMIN, COIN, RES, HFL, TES, SBCK, RWC, CQCK: TEST1: V _{IN} = V _{DD}			5	μA
	I _{IH} (2)	TAI, TEST2 to TEST5, CS, PCCL: V _{IN} = V _{DD} = 5.5 V	25		75	μA
Input low level current	I _{IL}	DEFI, EFMIN, COIN, RES, HFL, TES, SBCK, RWC, CQCK: TAI, TEST1 to TEST5, CS, PCCL: V _{IN} = 0 V	-5			μA
Output high level voltage	V _{OH} (1)	EFMO, CLV+, CLV-, V/P, PCK, FSEQ, TOFF, TGL, JP+, JP-, EMPH/CONT6, EFLG, FSX: I _{OH} = -1 mA	4			V
	V _{OH} (2)	MUTEL/CONT7, MUTER/CONT8, C2F, SBSY, PW, SFSY, WRQ, SQOUT, TST11, 16M, 4.2M, CONT1 to CONT5: I _{OH} = -0.5 mA	4			V
	V _{OH} (3)	DOUT: I _{OH} = -12 mA	4.5			V
Output low level voltage	V _{OL} (1)	EFMO, CLV+, CLV-, V/P, PCK, FSEQ, TOFF, TGL, JP+, JP-, EMPH/CONT6, EFLG, FSX: I _{OH} = 1 mA			1	V
	V _{OL} (2)	MUTEL/CONT7, MUTER/CONT8, C2F, SBSY, PW, SFSY, WRQ, SQOUT, TST11, 16M, 4.2M, CONT1 to CONT5: I _{OH} = 2 mA			0.4	V
	V _{OL} (3)	DOUT: I _{OH} = 12 mA			0.5	V
Output off leakage current	I _{OFF} (1)	PDO, CLV+, CLV-, JP+, JP-, CONT1 to CONT5: V _{OUT} = V _{DD}			5	μA
	I _{OFF} (2)	PDO, CLV+, CLV-, JP+, JP-, CONT1 to CONT5: V _{OUT} = 0 V	-5			μA
Charge pump output current	I _{PD0H}	PDO: R _{ISSET} = 68 kΩ	64	80	96	μA
	I _{PD0L}	PDO: R _{ISSET} = 68 kΩ	-96	-80	-64	μA

LC78622NE

One-Bit D/A Converter Analog Characteristics

at $T_a = 25^\circ\text{C}$, $V_{DD} = LV_{DD} = RV_{DD} = 5\text{ V}$, $V_{SS} = LV_{SS} = RV_{SS} = 0\text{ V}$

Parameter	Symbol	Conditions	min	typ	max	Unit
Total harmonic distortion	THD + N	LCHO, RCHO: 1 kHz: 0 dB data input, using the 20 kHz low-pass filter (AD725D built in)		0.009	0.012	%
Dynamic range	DR	LCHO, RCHO: 1 kHz: -60 dB data input, using the 20 kHz low-pass filter and the A filter (AD725D built in)	87	90		dB
Signal-to-noise ratio	S/N	LCHO, RCHO: 1 kHz: 0 dB data input, using the 20 kHz low-pass filter and the A filter (AD725D built in)	93	95		dB
Crosstalk	CT	LCHO, RCHO: 1 kHz: 0 dB data input, using the 20 kHz low-pass filter (AD725D built in)	82	84		dB

Note: Measured with the normal-speed playback mode in the Sanyo one-bit D/A converter block reference digital attenuator circuit set to EE (hexadecimal).

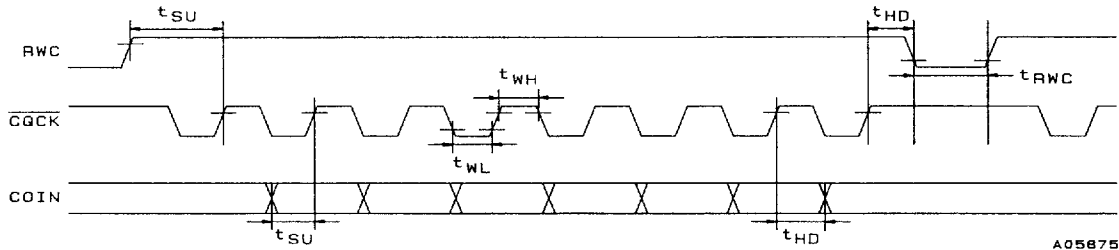
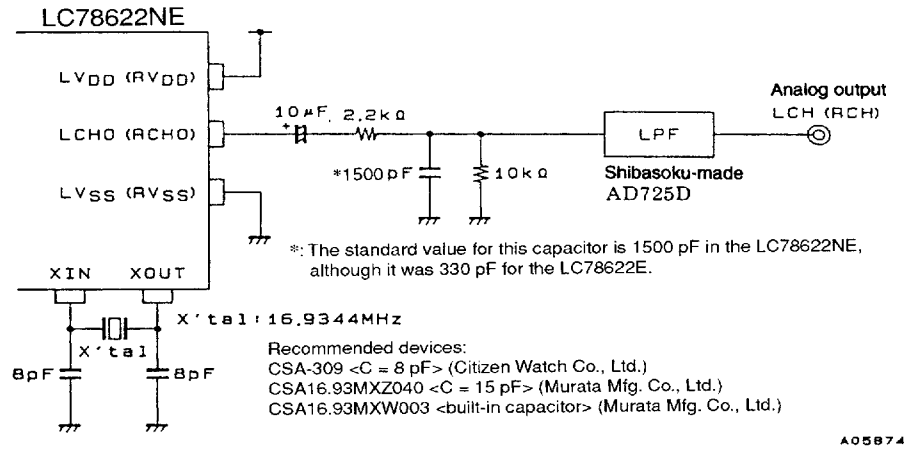
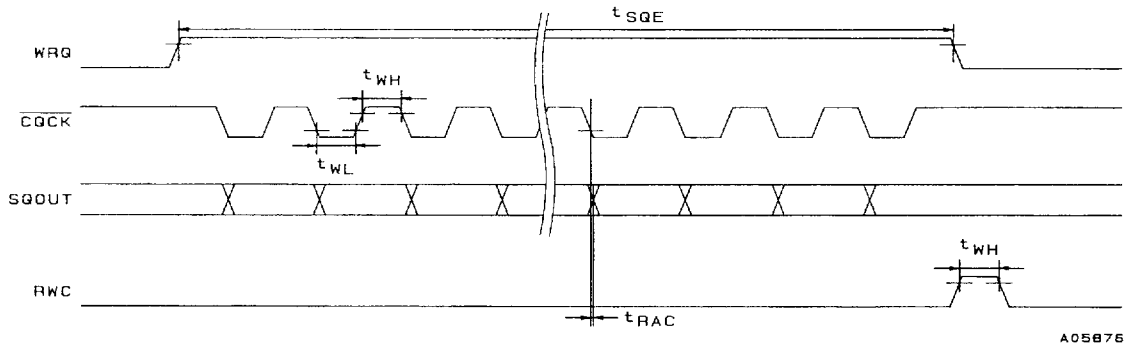
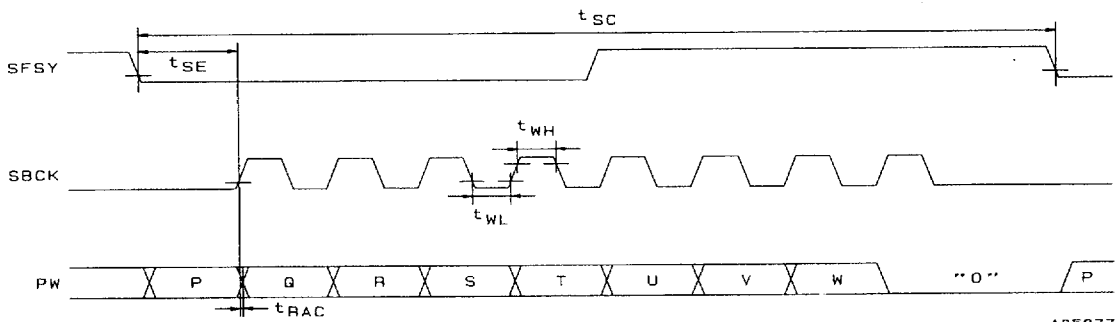

Figure 1 Command Input



A05876

Figure 2 Subcode Q Output



A05877

Figure 3 Subcode Output

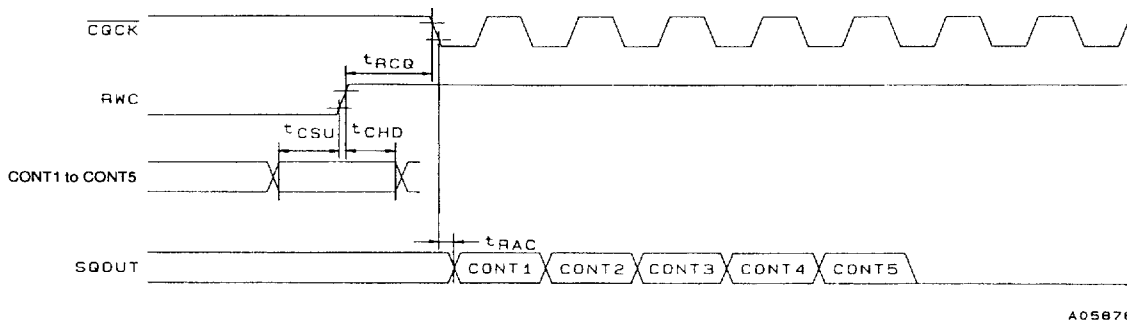

A05878

Figure 4 General-Purpose Port Input Timing

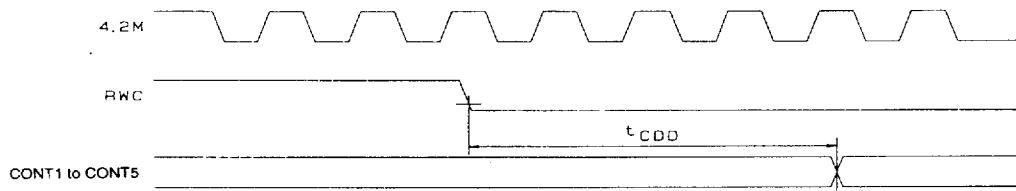

A05879

Figure 5 General-Purpose Port Output Timing

LC78622NE

Pin Functions

Pin No.	Symbol	I/O	Function		Output pin states during a reset
1	DEFI	I	Defect detection signal (DEF) input. (Must be connected to 0 V when unused.)		—
2	TAI	I	PLL pins	Test input. A pull-down resistor is built in. Must be connected to 0 V.	—
3	PDO	O		Internal VCO control phase comparator output	—
4	VV _{SS}	—		Internal VCO ground. Must be connected to 0 V.	—
5	ISET	AI		PDO output current adjustment resistor connection	—
6	VV _{DD}	—		Internal VCO power supply	—
7	FR	AI		VCO frequency range adjustment	—
8	V _{SS}	—		Digital system ground. Must be connected to 0 V.	
9	EFMO	O	Slice level control	EFM signal output	Undefined
10	EFMIN	I		EFM signal input	—
11	TEST2	I	Test input. A pull-down resistor is built in. Must be connected to 0 V.		—
12	CLV+	O	Disc motor control output.		Low-level output
13	CLV-	O	Three-value output is also possible when specified by microprocessor command.		Low-level output
14	V/P	O	Rough servo/phase control automatic switching monitor output. Outputs a high level during rough servo and a low level during phase control.		Low-level output
15	HFL	I	Track detection signal input. This is a Schmitt input.		—
16	TES	I	Tracking error signal input. This is a Schmitt input.		—
17	TOFF	O	Tracking off output		High-level output
18	TGL	O	Tracking gain switching output. Increase the gain when low.		Undefined
19	JP+	O	Track jump output.		Low-level output
20	JP-	O	Three-value output is also possible when specified by microprocessor command.		Low-level output
21	PCK	O	EFM data playback clock monitor. Outputs 4.3218 MHz when the phase is locked.		Low-level output
22	FSEQ	O	Synchronization signal detection output. Outputs a high level when the synchronization signal detected from the EFM signal and the internally generated synchronization signal agree.		Undefined
23	V _{DD}	—	Digital system power supply.		—
24	CONT1	I/O	General-purpose I/O pin 1	Controlled by serial data commands from the microprocessor. Any of these that are unused must be either set up as input ports and connected to 0 V, output ports and set up as left open.	Input
25	CONT2	I/O	General-purpose I/O pin 2		Input
26	CONT3	I/O	General-purpose I/O pin 3		Input
27	CONT4	I/O	General-purpose I/O pin 4		Input
28	CONT5	I/O	General-purpose I/O pin 5		Input
29	EMPH/CONT6	O	De-emphasis monitor pin. A high level indicates playback of an emphasis disk./general-purpose I/O port 6		Low-level output
30	C2F	O	C2 flag output		Undefined
31	DOUT	O	Digital output. (EIAJ format)		Undefined
32	TEST3	I	Test input. A pull-down resistor is built in. Must be connected to 0 V.		—
33	TEST4	I	Test input. A pull-down resistor is built in. Must be connected to 0 V.		—
34	PCCL	I	General-purpose I/O command identification pin. A pull-down resistor is built in. If only the same functions as those provided by the LC78622E are used, this pin must be left open or connected to 0 V. High: Only the general-purpose I/O port commands are allowed. Low: All commands are allowed.		—
35	MUTEL/CONT7	O	Left channel one-bit D/A converter	Left channel mute output/general-purpose I/O port 7	High-level output
36	LV _{DD}	—		Left channel power supply	—
37	LCHO	O	Right channel one-bit D/A converter	Left channel output	—
38	LV _{SS}	—		Left channel ground. Must be connected to 0 V.	—
39	RV _{SS}	—	Right channel one-bit D/A converter	Right channel ground. Must be connected to 0 V.	—
40	RCHO	O		Right channel output	—
41	RV _{DD}	—	Right channel one-bit D/A converter	Right channel power supply	—
42	MUTER/CONT8	O		Right channel mute output/general-purpose I/O port 8	High-level output
43	XV _{DD}	—	Crystal oscillator power supply.		—
44	X _{OUT}	O	Connections for a 16.9344 MHz crystal oscillator element		—
45	X _{IN}	I			—
46	XV _{SS}	—	Crystal oscillator ground. Must be connected to 0 V.		—
47	SBSY	O	Subcode block synchronization signal output		Undefined
48	EFLG	O	C1, C2, single and double error correction monitor pin		Undefined
49	PW	O	Subcode P, Q, R, S, T, U, V and W output		Undefined
50	SFSY	O	Subcode frame synchronization signal output. This signal falls when the subcodes are in the standby state.		Undefined

Continued on next page.



LC78622NE

Continued from preceding page.

Pin No.	Symbol	I/O	Function	Output pin states during a reset
51	SBCK	I	Subcode readout clock input. This is a Schmitt input. (Must be connected to 0 V when unused.)	—
52	FSX	O	Output for the 7.35 kHz synchronization signal divided from the crystal oscillator	Undefined
53	WRQ	O	Subcode Q output standby output	Undefined
54	RWC	I	Read/write control input. This is a Schmitt input.	—
55	SQOUT	O	Subcode Q output	Undefined
56	COIN	I	Command input from the control microprocessor	—
57	CQCK	I	Input for both the command input clock and the subcode readout clock. This is a Schmitt input.	—
58	RES	I	Chip reset input. This pin must be set low briefly after power is first applied.	—
59	TST11	O	Test output. Leave open. (Normally outputs a low level.)	Low-level output
60	16M	O	16.9344 MHz output.	Clock output
61	4.2M	O	4.2336 MHz output	Clock output
62	TEST5	I	Test input. A pull-down resistor is built in. Must be connected to 0 V.	—
63	CS	I	Chip select input. A pull-down resistor is built in. Must be connected to 0 V if not controlled.	—
64	TEST1	I	Test input. No pull-down resistor. Must be connected to 0 V.	—

Note: The same potential must be supplied to all power supply pins, i.e., V_{DD}, VV_{DD}, LV_{DD}, RV_{DD}, and XV_{DD}.

Pin Applications

1. HF Signal Input Circuit; Pin 10: EFMIN, pin 9: EFMO, pin 1: DEFI, pin 12: CLV+

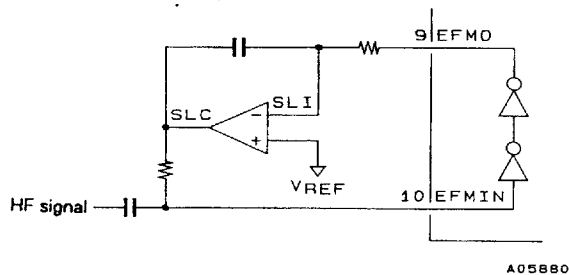

An EFM signal (NRZ) sliced at an optimal level can be acquired by inputting the HF signal to EFMIN.

The LC78622NE handles defects as follows. When a high level is input to the DEFI pin (pin 1), EFMO (pin 9) pins (the slice level control outputs) go to the high-impedance state, and the slice level is held. However, note that this function is only valid in CLV phase control mode, that is, when the V/P pin (pin 14) is low. This function can be used in combination with the LA9240M and LA9241M DEF pins.

Note: If the EFMIN and CLV+ signal lines are too close to each other, unwanted radiation can result in error rate degradation. We recommend laying a ground or V_{DD} shield line between these two lines.

2. PLL Clock Generation Circuit; Pin 3: PDO, pin 5: ISET, pin 7: FR, pin 21: PCK

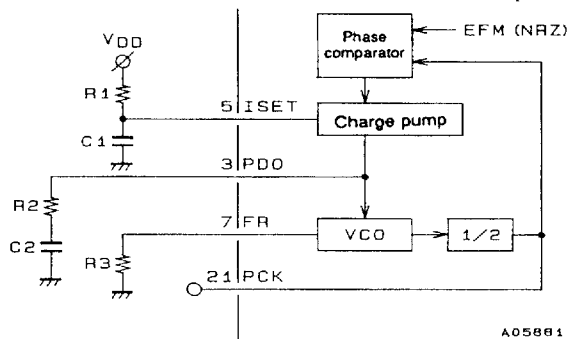

Since the LC78622NE includes a VCO circuit, a PLL circuit can be formed by connecting an external RC circuit. ISET is the charge pump reference current, PDO is the VCO circuit loop filter, and FR is a resistor that determines the VCO frequency range.

(Reference values)

$$R1 = 68 \text{ k}\Omega, C1 = 0.1 \text{ }\mu\text{F}$$

$$R2 = 680 \text{ }\Omega, C2 = 0.1 \text{ }\mu\text{F}$$

$$R3 = 1.2 \text{ k}\Omega$$

3. VCO Monitor; Pin 21: PCK

PCK is a monitor pin that outputs an average frequency of 4.3218 MHz, which is divided from the VCO frequency.

4. Synchronization Detection Monitor; Pin 22: FSEQ

Pin 22 goes high when the frame synchronization (a positive polarity synchronization signal) from the EFM signal read in by PCK and the timing generated by the counter (the interpolation synchronization signal) agree. This pin is thus a synchronization detection monitor. (It is held high for a single frame.)

5. Servo Command Function; Pin 54: RWC, pin 56: COIN, pin 57: \overline{CQCK}

Commands can be executed by setting RWC high and inputting commands to the COIN pin in synchronization with the \overline{CQCK} clock. Note that commands are executed on the falling edge of RWC.

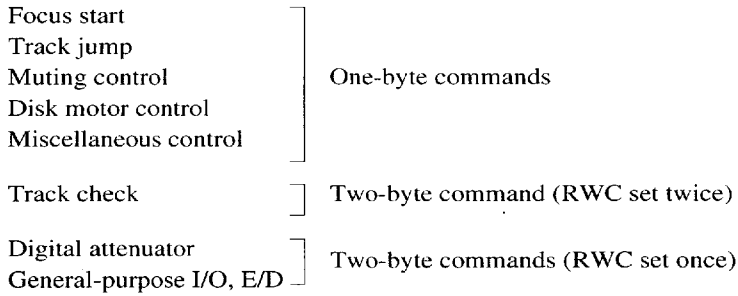

• One-byte commands

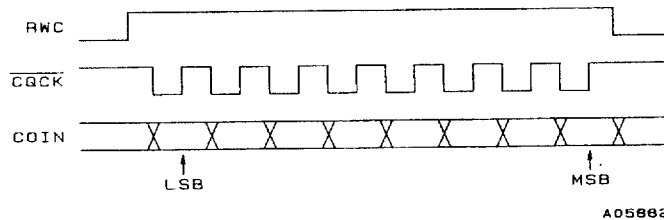

• Two-byte commands (RWC set twice: For track checking)

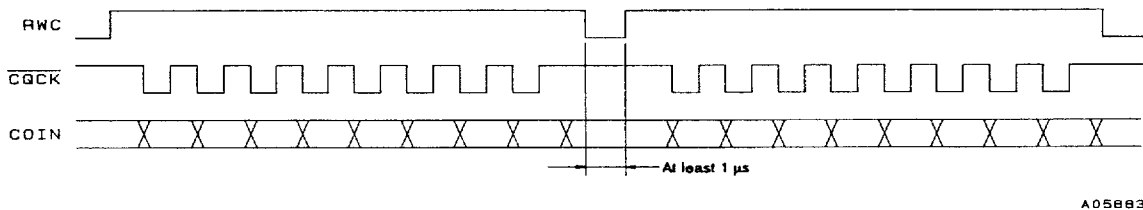

LC78622NE

- Two-byte commands (RWC set once: Sets up the digital attenuation and the general-purpose I/O ports)

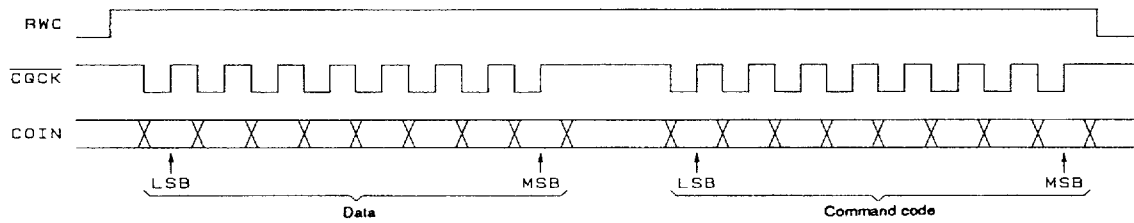

A05884

- Command noise rejection

MSB	LSB	Command	$\overline{\text{RES}} = \text{low}$
1	1	COMMAND INPUT NOISE REDUCTION MODE	○
1	0	RESET NOISE EXCLUSION MODE	

This command reduces the noise on the $\overline{\text{CQCK}}$ clock signal. While this is effective for noise pulses shorter than 500 ns, the $\overline{\text{CQCK}}$ timings t_{WL} , t_{WH} , and t_{SU} , must be set for at least 1 μs .

6. CLV Servo Circuit; Pin 12: CLV+, pin 13: CLV-, pin 14: $\overline{\text{V/P}}$

MSB	LSB	Command	$\overline{\text{RES}} = \text{low}$
0	0	DISC MOTOR START (accelerate)	○
0	1	DISC MOTOR CLV (CLV)	
1	0	DISC MOTOR BRAKE (decelerate)	
1	1	DISC MOTOR STOP (stop)	

The CLV+ pin provides the signal that accelerates the disk in the forward direction and the CLV- pin provides the signal that decelerates the disk. Commands from the control microprocessor select one of four modes; accelerate, decelerate, CLV and stop. The table below lists the CLV+ and CLV- outputs in each of these modes.

Mode	CLV+	CLV-
Accelerate	High	Low
Decelerate	Low	High
CLV	Pulse output	Pulse output
Stop	Low	Low

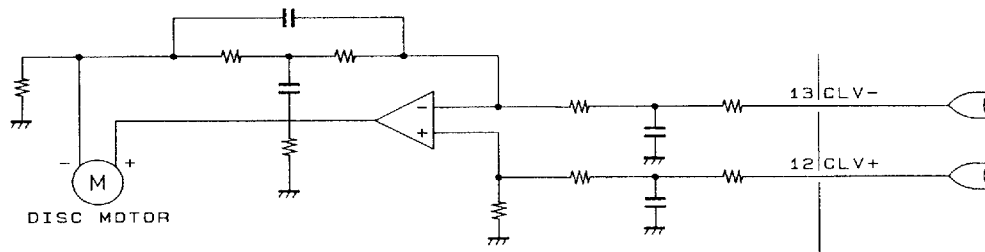

A05885

Note: CLV servo control commands can set the TOFF pin low only in CLV mode. That pin will be at the high level at all other times. Control of the TOFF pin by microprocessor command is only valid in CLV mode.

LC78622NE

- CLV mode

In CLV mode the LC78622NE detects the disk speed from the HF signal and provides proper linear speed using several different control schemes by switching the DSP internal modes. The PWM reference period corresponds to a frequency of 7.35 kHz. The V/P pin outputs a high level during rough servo and a low level during phase control.

Internal mode	CLV+	CLV-	V/P
Rough servo (velocity too low)	High	Low	High
Rough servo (velocity too high)	Low	High	High
Phase control (PCK locked)	PWM	PWM	Low

- Rough servo gain switching

MSB	LSB	Command	$\overline{\text{RES}} = \text{low}$
1	0 1 0 1 0 0 0	DISC 8 SET	○
1	0 1 0 1 0 0 1	DISC 12 SET	

For 8 cm disks, the rough servo mode CLV control gain can be set about 8.5 dB lower than the gain used for 12 cm disks.

- Phase control gain switching

MSB	LSB	Command	$\overline{\text{RES}} = \text{low}$
1	0 1 1 0 0 0 1	CLV PHASE COMPARATOR DIVISOR: 1/2	○
1	0 1 1 0 0 1 0	CLV PHASE COMPARATOR DIVISOR: 1/4	
1	0 1 1 0 0 1 1	CLV PHASE COMPARATOR DIVISOR: 1/8	
1	0 1 1 0 0 0 0	NO CLV PHASE COMPARATOR DIVISOR USED	

The phase control gain can be changed by changing the divisor used by the dividers in the stage immediately preceding the phase comparator.

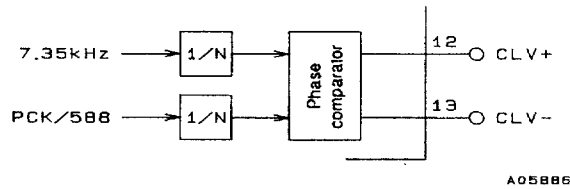

LC78622NE

• CLV three-value output

MSB	LSB	Command	RES = low
1 0 1 1 0 1 0 0		CLV THREE VALUE OUTPUT	○
1 0 1 1 0 1 0 1		CLV TWO VALUE OUTPUT (the scheme used by previous products)	

The CLV three-value output command allows the CLV to be controlled by a single pin.

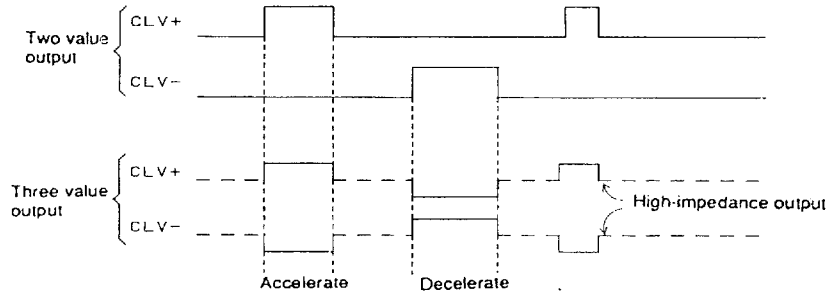

A05887

• Internal brake modes

MSB	LSB	Command	RES = low
1 1 0 0 0 1 0 1		INTERNAL BRAKE ON	○
1 1 0 0 0 1 0 0		INTERNAL BRAKE OFF	
1 0 1 0 0 0 1 1		INTERNAL BRAKE CONTROL	
1 1 0 0 1 0 1 1		INTERNAL BRAKE CONTINUOUS MODE	○
1 1 0 0 1 0 1 0		RESET CONTINUOUS MODE	
1 1 0 0 1 1 0 1		TON MODE DURING INTERNAL BRAKING	○
1 1 0 0 1 1 0 0		RESET TON MODE	

- Issuing the internal brake-on (C5H) command sets the LC78622NE to internal brake mode. In this mode, the disk deceleration state can be monitored from the WRQ pin when a brake command (06H) is executed.
- In this mode the disk deceleration state is determined by counting the EFM signal density in a single frame, and when the EFM signal count falls under four, the CLV- pin is dropped to low. At the same time the WRQ signal, which functions as a brake completion monitor, goes high. When the microprocessor detects a high level on the WRQ signal, it should issue a STOP command to fully stop the disk. In internal brake continuous mode (CBH), the CLV- pin high-level output braking operation continues even after the WRQ brake completion monitor goes high.
Note that if errors occur in deceleration state determination due to noise in the EFM signal, the problem may be rectified by changing the EFM signal count from four to eight with the internal brake control command (A3H).
- In TOFF output disabled mode (CDH), the TOFF pin is held low during internal brake operations. We recommend using this feature, since it is effective at preventing incorrect detection at the disk mirror surface.

LC78622NE

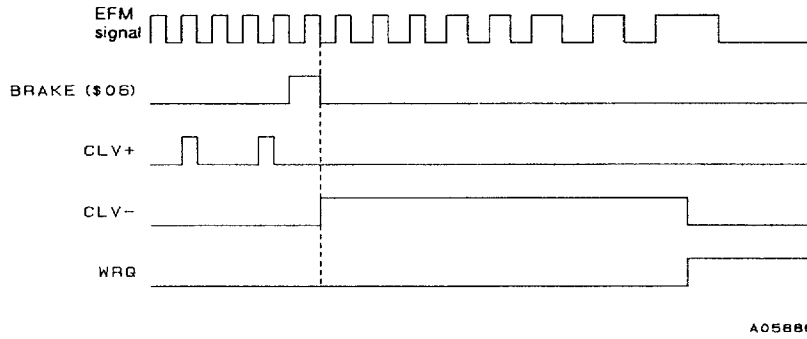

- Note: 1. If focus is lost during the execution of an internal brake command, the pickup must first be refocused and then the internal brake command must be reissued.
2. Since incorrect deceleration state determination is possible depending on the EFM signal playback state (e.g., disk defects, access in progress), we recommend using these functions in combination with a microprocessor.

7. Track Jump Circuit; Pin 15: HFL, pin 16: TES, pin 17: TOFF, pin 18: TGL, pin 19: JP+, pin 20: JP-

- The LC78622NE supports the two track count modes listed below.

MSB	LSB	Command	RES = low						
0	0	1	0	0	0	1	0	NEW TRACK COUNT (using the TES/HFL combination)	○
0	0	1	0	0	0	1	1	STANDARD TRACK COUNT (directly counts the TES signal)	

The earlier track count function uses the TES signal directly as the internal track counter clock. To reduce counting errors resulting from noise on the rising and falling edges of the TES signal, the new track count function prevents noise induced errors by using the combination of the TES and HFL signals, and implements a more reliable track count function. However, dirt and scratches on the disk can result in HFL signal dropouts that may result in missing track count pulses. Thus care is required when using this function.

LC78622NE

• TJ commands

MSB	LSB	Command	RES = low
1 0 1 0 0 0 0 0		STANDARD TRACK JUMP	○
1 0 1 0 0 0 0 1		NEW TRACK JUMP	
0 0 0 1 0 0 0 1		1 TRACK JUMP IN #1	
0 0 0 1 0 0 1 0		1 TRACK JUMP IN #2	
0 0 1 1 0 0 0 1		1 TRACK JUMP IN #3	
0 1 0 1 0 0 1 0		1 TRACK JUMP IN #4	
0 0 0 1 0 0 0 0		2 TRACK JUMP IN	
0 0 0 1 0 0 1 1		4 TRACK JUMP IN	
0 0 0 1 0 1 0 0		16 TRACK JUMP IN	
0 0 1 1 0 0 0 0		32 TRACK JUMP IN	
0 0 0 1 0 1 0 1		64 TRACK JUMP IN	
0 0 0 1 0 1 1 1		128 TRACK JUMP IN	
0 0 0 1 1 0 0 1		1 TRACK JUMP OUT #1	
0 0 0 1 1 0 1 0		1 TRACK JUMP OUT #2	
0 0 1 1 1 0 0 1		1 TRACK JUMP OUT #3	
0 1 0 1 1 0 1 0		1 TRACK JUMP OUT #4	
0 0 0 1 1 0 0 0		2 TRACK JUMP OUT	
0 0 0 1 1 0 1 1		4 TRACK JUMP OUT	
0 0 0 1 1 1 0 0		16 TRACK JUMP OUT	
0 0 1 1 1 0 0 0		32 TRACK JUMP OUT	
0 0 0 1 1 1 0 1		64 TRACK JUMP OUT	
0 0 0 1 1 1 1 1		128 TRACK JUMP OUT	
0 0 0 1 0 1 1 0		256 TRACK CHECK	
0 0 0 0 1 1 1 1		TOFF	○
1 0 0 0 1 1 1 1		TON	
1 0 0 0 1 1 0 0		TRACK JUMP BRAKE	
0 0 1 0 0 0 0 1		TOFF OUTPUT MODE DURING JP PULSE PERIOD	
0 0 1 0 0 0 0 0		RESET TOFF OUTPUT MODE DURING JP PULSE PERIOD	○

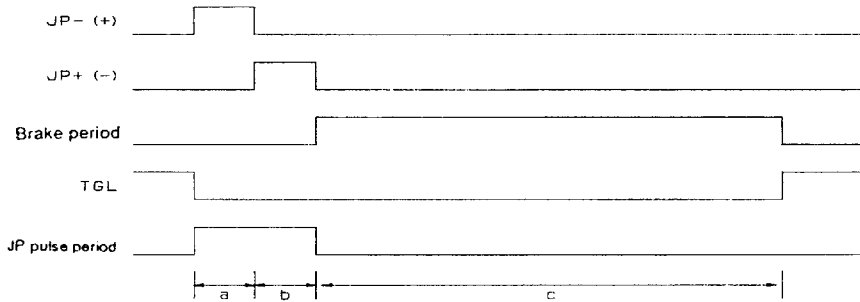

A05689

When the LC78622NE receives a track jump instruction as a servo command, it first generates accelerating pulses (period a) and next generates deceleration pulses (period b). The passage of the braking period (period c) completes the specified jump. During the braking period, the LC78622NE detects the beam slip direction from the TES and HFL inputs. TOFF is used to cut the components in the TES signal that aggravate slip. The jump destination track is captured by increasing the servo gain with TGL. In during TOFF output mode JP pulse period the TOFF signal is held high during the JP pulse generation period.

Note: Of the modes related to disk motor control, the TOFF pin only goes low in CLV mode, and will be high during accelerate, stop, and decelerate modes. Note that the TOFF pin can be turned on and off independently by microprocessor issued commands. However, this function is only valid when disk motor control is in CLV mode.

LC78622NE

- Track jump modes

The table lists the relationships between acceleration pulses (the a period), deceleration pulses (the b period), and the braking period (the c period).

Command	Standard track jump mode			New track jump mode		
	a	b	c	a	b	c
1 TRACK JUMP IN (OUT) #1	233 μ s	233 μ s	60 ms	233 μ s	233 μ s	60 ms
1 TRACK JUMP IN (OUT) #2	0.5 track jump period	233 μ s	60 ms	0.5 track jump period	The same time as "a"	60 ms
1 TRACK JUMP IN (OUT) #3	0.5 track jump period	233 μ s	This period does not exist.	0.5 track jump period	The same time as "a"	This period does not exist.
1 TRACK JUMP IN (OUT) #4	0.5 track jump period	233 μ s	60 ms; TOFF is low during the C period.	0.5 track jump period	The same time as "a"	60 ms; TOFF is low during the C period.
2 TRACK JUMP IN (OUT)	None	None	None	1 track jump period	The same time as "a"	60 ms
4 TRACK JUMP IN (OUT)	2 track jump period	466 μ s	60 ms	2 track jump period	The same time as "a"	60 ms
16 TRACK JUMP IN (OUT)	9 track jump period	7 track jump period	60 ms	9 track jump period	The same time as "a"	60 ms
32 TRACK JUMP IN (OUT)	18 track jump period	14 track jump period	60 ms	18 track jump period	14 track jump period	60 ms
64 TRACK JUMP IN (OUT)	36 track jump period	28 track jump period	60 ms	36 track jump period	28 track jump period	60 ms
128 TRACK JUMP IN (OUT)	72 track jump period	56 track jump period	60 ms	72 track jump period	56 track jump period	60 ms
256 TRACK CHECK	TOFF goes high during the period when 256 tracks are passed over. The a and b pulses are not output.			TOFF goes high during the period when 256 tracks are passed over. The a and b pulses are not output.		
TRACK JUMP BRAKE	There are no a or b periods.			There are no a and b periods.		

- Note: 1. As indicated in the table, actuator signals are not output during the 256 TRACK CHECK function. This is a mode in which the TES signal is counted in the tracking loop off state. Therefore, feed motor forwarding is required.
2. The servo command register is automatically reset after one cycle of the track jump sequence (a, b, c) completes.
3. If another track jump command is issued during a track jump operation, the content of that new command will be executed starting immediately.
4. The 1 TRACK JUMP #3 mode does not have a braking period (the C period). Since brake mode must be generated by an external circuit, care is required when using this mode.
5. While there was no braking period (the C period) in the LC78620E/21E for the new track jump command "2 TRACK JUMP IN (OUT)", this has been changed in this LSI, which has a C period of 60 ms.

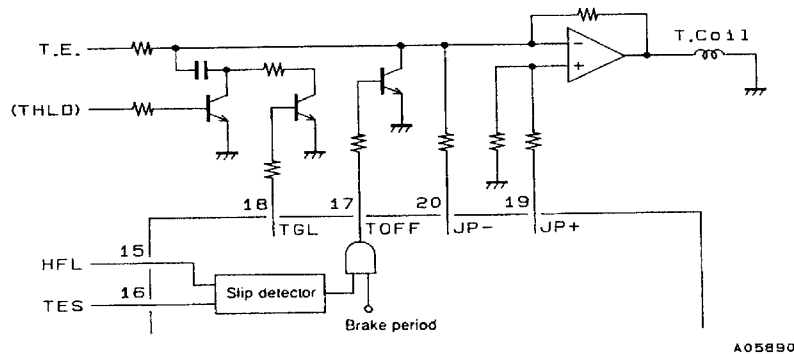

The THLD signal is generated by the LA9230M, LA9231M, or LA9240M, and the tracking signal is held during the JP pulse period.

LC78622NE

5. Tracking brake

The chart shows the relationships between the TES, HFL, and TOFF signals during the track jump C period. The TOFF signal is extracted from the HFL signal by TES signal edges. When the HFL signal is high, the pickup is over the mirror surface, and when low, the pickup is over data bits. Thus braking is applied based on the TOFF signal being high when the pickup is moving from a mirror region to a data region and being low when the pickup is moving from a data region to a mirror region.

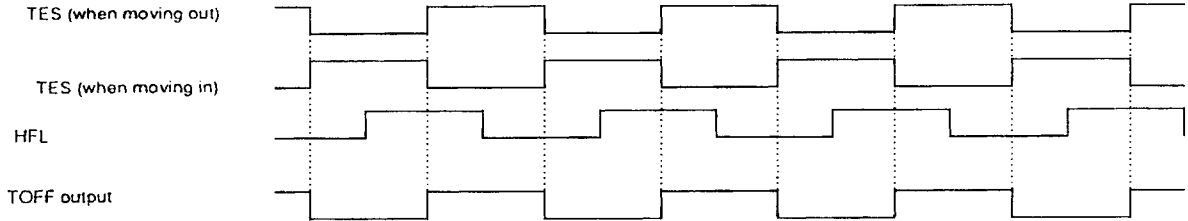

• JP three-value output

MSB	LSB	Command	RES = low
1	0 1 1 0 1 1 0	JP THREE VALUE OUTPUT	
1	0 1 1 0 1 1 1	JP TWO VALUE OUTPUT (earlier scheme)	○

The JP three-value output command allows the track jump operation to be controlled from a single pin.

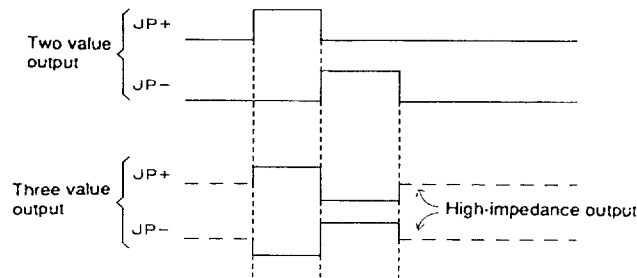

A05892

• Track check mode

MSB	LSB	Command	RES = low
1	1 1 1 1 0 0 0 0	TRACK CHECK IN	
1	1 1 1 1 1 0 0 0	TRACK CHECK OUT	
1	1 1 1 1 1 1 1 1	TWO BYTE COMMAND RESET	○

The LC78622NE will count the specified number of tracks plus one when the microprocessor sends an arbitrary binary value in the range 8 to 254 after issuing either a track check in or a track check out command.

Note: Data for the desired track count must not be set to the general-purpose command \$D9 to \$DF.

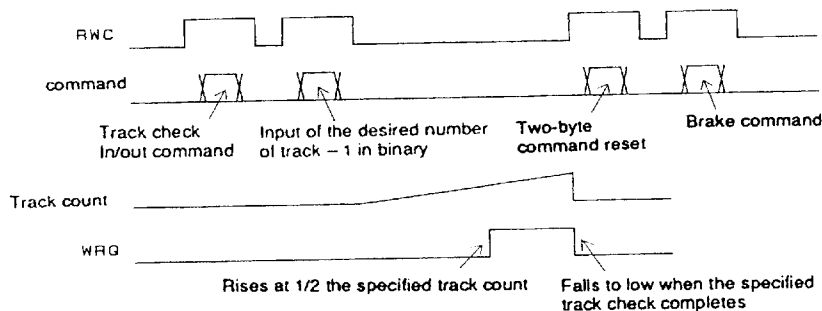

A05893

LC78622NE

- Note:
1. When the desired track count has been input in binary, the track check operation is started by the fall of RWC.
 2. During a track check operation the TOFF pin goes high and the tracking loop is turned off. Therefore, feed motor forwarding is required.
 3. When a track check in/out command is issued the function of the WRQ signal switches from the normal mode subcode Q standby monitor function to the track check monitor function. This signal goes high when the track check is half completed, and goes low when the check finishes. The control microprocessor should monitor this signal for a low level to determine when the track check completes.
 4. If a two-byte reset command is not issued, the track check operation will repeat. That is, to skip over 20,000 tracks, issue a track check 199 command once, and then count the WRQ signal 100 times. This will check 20,000 tracks.
 5. After performing a track check operation, use the brake command to have the pickup lock onto the track.

8. Error Flag Output; Pin 48: EFLG, pin 52: FSX

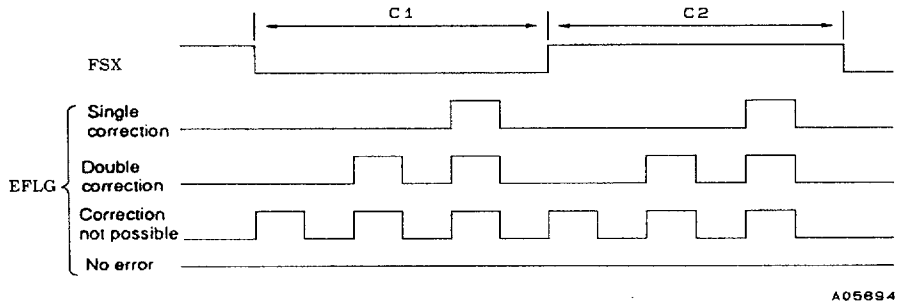

The FSX signal is generated by dividing the crystal oscillator clock, and is a 7.35 kHz frame synchronization signal. The error correction state for each frame is output from EFLG. The FSX low-level period indicates the C1 correction state, and the high-level period indicates the C2 correction state. The playback OK/NG state can be easily determined from the extent of the high level that appears here.

9. Subcode P, Q and R to W Output Circuit; Pin 49: PW, pin 47: SBSY, pin 50: SFSY, pin 51: SBCK
- PW is the subcode signal output pin, and all the codes, P, Q, and R to W can be read out by sending eight clocks to the SBCK pin within 136 μ s after the fall of SFSY. The signal that appears on the PW pin changes on the rising edge of SBCK. If a clock is not applied to SBCK, the P code will be output from PW. SFSY is a signal that is output for each subcode frame cycle, and the falling edge of this signal indicates standby for the output of the subcode symbol (P to W). Subcode data P is output on the fall of this signal.

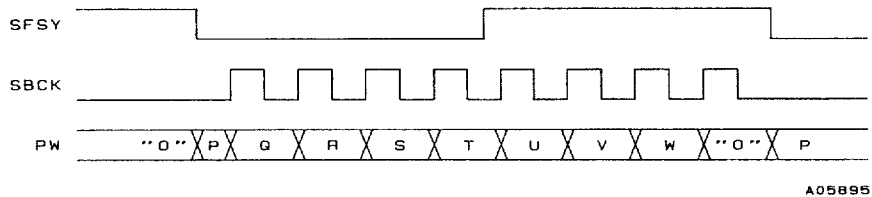

SBSY is a signal output for each subcode block. This signal goes high for the S0 and S1 synchronization signals. The fall of this signal indicates the end of the subcode synchronization signals and the start of the data in the subcode block. (EIAJ format)

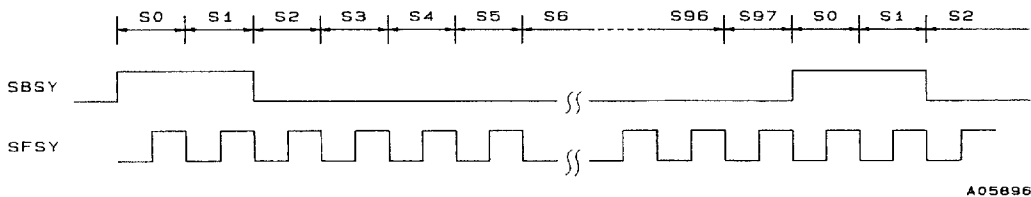

LC78622NE

10. Subcode Q Output Circuit; Pin 53: WRQ, pin 54: RWC, pin 55: SQOUT, pin 57: CQCK, pin 63: CS

MSB	LSB	Command	RES = low
0	0 0 0 1 0 0 1	ADDRESS FREE	○
1	0 0 0 1 0 0 1	ADDRESS 1	

Subcode Q can be read from the SQOUT pin by applying a clock to the \overline{CQCK} pin.

Of the eight bits in the subcode, the Q signal is used for song (track) access and display. The WRQ will be high only if the data passed the CRC error check and the subcode Q format internal address is 1*. The control microprocessor can read out data from SQOUT in the order shown below by detecting this high level and applying \overline{CQCK} . When \overline{CQCK} is applied the DSP disables register update internally. The microprocessor should give update permission by setting RWC high briefly after reading has completed. WRQ will fall to low at this time. Since WRQ falls to low 11.2 ms after going high, \overline{CQCK} must be applied during the high period. Note that data is read out in an LSB first format.

Note: * That state will be ignored if an address free command is input. This is provided to handle CD-ROM applications.

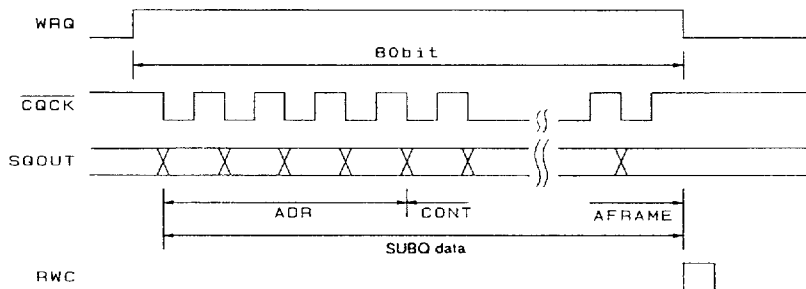
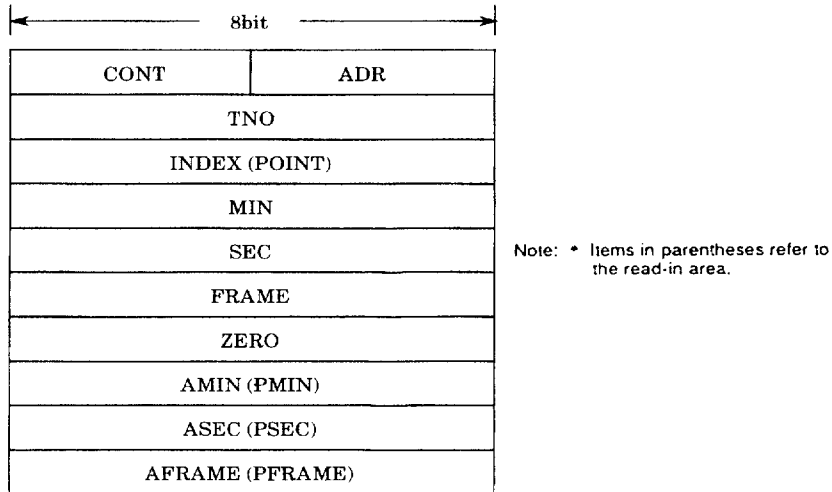

- Note: 1. Normally, the WRQ pin indicates the subcode Q standby state. However, it is used for a different monitoring purpose in track check mode and during internal braking. (See the items on track counting and internal braking for details.)
2. The LC78622NE becomes active when the CS pin is low, and subcode Q data is output from the SQOUT pin. When the \overline{CS} pin is high, the SQOUT pin goes to the high-impedance state.

11. Bilingual Function

MSB	LSB	Command	$\overline{RES} = \text{low}$
0 0 1 0 1 0 0 0		STO CONT	○
0 0 1 0 1 0 0 1		Lch CONT	
0 0 1 0 1 0 1 0		Rch CONT	

- Following a reset or when a stereo (28H) command has been issued, the left and right channel data is output to the left and right channels respectively.
- When an Lch set (29H) command is issued, the left and right channels both output the left channel data.
- When an Rch set (2AH) command is issued, the left and right channels both output the right channel data.

12. De-Emphasis; Pin 29: EMPH/CONT6

The preemphasis on/off bit in the subcode Q control information is output from the EMPH pin. When this pin is high, the LC78622NE internal de-emphasis circuit operates and the digital filters and the D/A converter output de-emphasized data.

13. Digital Attenuator

Digital attenuation can be applied to the audio data by setting the RWC pin high and inputting the corresponding two-byte command to the COIN pin in synchronization with the \overline{CQCK} clock.

MSB	LSB	Command	$\overline{RES} = \text{low}$
1 0 0 0 0 0 0 1		ATT DATA SET	▶ DATA 00H set (MUTE $-\infty$ dB)
1 0 0 0 0 0 1 0		ATT 4 STEP UP	
1 0 0 0 0 0 1 1		ATT 4 STEP DOWN	
1 0 0 0 0 1 0 0		ATT 8 STEP UP	
1 0 0 0 0 1 0 1		ATT 8 STEP DOWN	
1 0 0 0 0 1 1 0		ATT 16 STEP UP	
1 0 0 0 0 1 1 1		ATT 16 STEP DOWN	

• Attenuation setup

Since the attenuation level is set to the muted state (a muting of $-\infty$ is specified by an attenuation coefficient of 00H) after the attenuation level is reset, the attenuation coefficient must be directly set to EEH (using the ATT DATA SET command) to output audio signals. Note that the attenuation level can be set to one of 239 values from 00H to EEH.

These two-byte commands differ from the two-byte commands used for track counting in that it is only necessary to set RWC once and a two-byte command reset is not required. After inputting the target attenuation level as a value in the range 00H to EEH, sending an attenuator step up/down command will cause the attenuation level to approach the target value in steps of 4, 8, or 16 units as specified in synchronization with rising edges on the LRSY input. However, the ATT DATA SET command sets the target value directly. If a new data value is input during the transition, the value begins to approach the new target value at that point. Note that the UP/DOWN distinction is significant here.

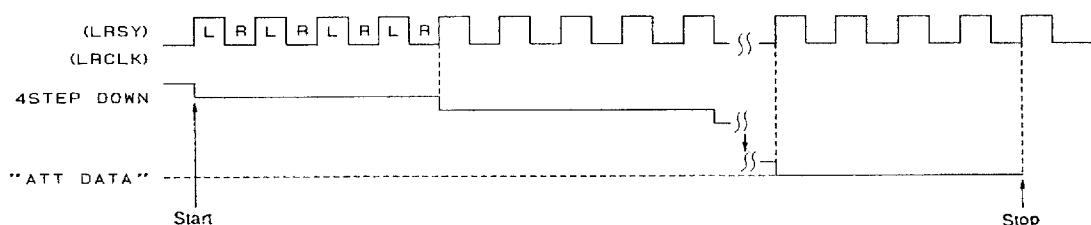

A05698

LC78622NE

$$\text{Audio output level} = 20 \log \frac{\text{ATT DATA}}{100\text{H}} [\text{dB}]$$

For example, the formula below calculates the time required for the attenuation level to increase from 00H to EEH when a 4STEP UP command is executed. Note that the control microprocessor must provide enough of a time margin for this operation to complete before issuing the next attenuation level set command.

$$\frac{238 \text{ level} \times 4\text{STEP UP}}{44.1 \text{ kHz}} \approx 21.6 \text{ ms}$$

Note: Setting the attenuation level to values of EFH or higher is disallowed to prevent overflows in one-bit D/A converter calculations from causing noise.

14. Mute Output; Pin 35: MUTEL/CONT7, pin 42: MUTER/CONT8

15. C2 Flag Output; Pin 30: C2F
C2F output flag information in 8-bit units.

16. Digital Output Circuit; Pin 31: DOUT
This is an output pin for use with a digital audio interface. Data is output in the EIAJ format. This signal has been processed by the interpolation and muting circuits. This pin has a built-in driver circuit and can directly drive a transformer.

MSB	LSB	Command	$\overline{\text{RES}} = \text{low}$
0 1 0 0 0 0 1 0		DOUT ON	○
0 1 0 0 0 0 1 1		DOUT OFF	
0 1 0 0 0 0 0 0		UBIT ON	○
0 1 0 0 0 0 0 1		UBIT OFF	
1 0 0 0 1 0 0 0		CDROM-XA	
1 0 0 0 1 0 1 1		ROMXA-RST	○

- The DOUT pin can be locked at the low level by issuing a DOUT OFF command.
- The UBIT information in the DOUT data can be locked at zero by issuing a UBIT OFF command.
- The DOUT data can be switched to data for which interpolation and muting processing have not been performed by issuing a CD-ROM XA command.
- When searching and when returning the pickup to its initial position, there are cases when the frequency output data will contain a parity error and locking is lost temporarily. To prevent this, we recommend directly executing a UBIT OFF (\$41) command and then directly executing a UBIT ON (\$40) command when searching and when returning the pickup to its initial position.

17. Mute Control Circuit

MSB	LSB	Command	$\overline{\text{RES}} = \text{low}$
0 0 0 0 0 0 0 1		MUTE: 0 dB	
0 0 0 0 0 0 1 1		MUTE: -∞ dB	○

Inputting the above command mutes the audio level (MUTE -∞ dB). Since zero-cross muting is used, there is very little noise associated with this operation. The IC defines zero cross to be the ranges where the upper 7 bits of the data are all zeros or all ones. Note that the MUTE -12 dB instruction supported by the LC78620E has been removed from this product.

18. Interpolation Circuit

Outputting incorrect audio data that could not be corrected by the error detection and correction circuit would result in loud noises being output. To minimize this noise, the LC78622NE replaces the incorrect data with linearly interpolated data based on the correct data on either side of the incorrect data. If one set of C2 flags indicate errors, the above replacement is performed, and if two or more sets of C2 flags indicate errors, the IC holds the previous value. However, when correct data is output following two or more consecutive C2 flags indicating errors, the data point between the correct data and the data output two points previously (the held value) is replaced with a value computed by linearly interpolating those two values.

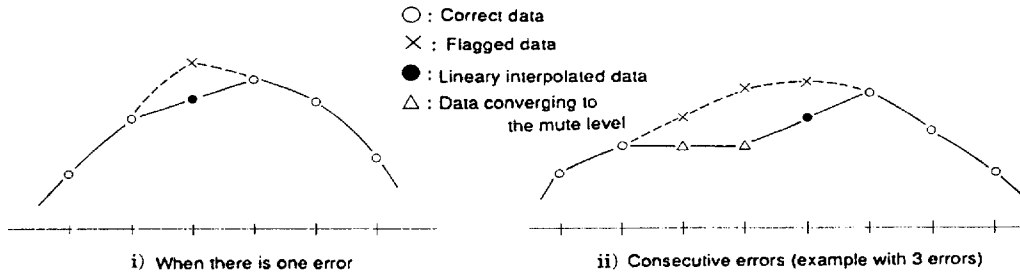

19. General-Purpose I/O Ports; Pin 24: CONT1, Pin 25: CONT2, Pin 26: CONT3, Pin 27: CONT4, Pin 28: CONT5, Pin 29: EMPH/CONT6, Pin 34: PCCL, Pin 35: MUTEL/CONT7, Pin 42: MUTER/CONT8

The LC78622NE provides five I/O ports CONT1 to CONT5 and three output ports CONT6 to CONT8. After a reset, these five I/O ports are set to function as input pins and the three output ports are set to function as EMPH, MUTEL, and MUTER pins, respectively. Unused I/O ports must be connected to ground set to function as input ports or set to function as output ports.

Code	Command	RES = low
\$DD	PORT READ	
\$DB	PORT I/O SET	PORT I SET
\$DC	PORT OUTPUT SET	
\$D9	Enable the CONT6 function	
\$DA	Enable the EMPH function	○
\$DE	Enable the CONT7 and CONT8 functions	
\$DF	Enable the MUTEL and MUTER functions	○

The port information can be read out from the SQOUT pin in synchronization with the falling edge of the \overline{CQCK} signal in the order CONT1 to CONT5 by using the PORT READ command. When the pin WRQ enters 'H' level by the subcode Q output while controlling general-purpose port, the data for the subcode Q should be invalid and another subcode Q should be read out. This command has the 1-byte command format. Command control limited to only the general-purpose ports is possible by using the PCCL pin setting, even during track check, track jump, and internal MTR braking operations. When using the general-purpose port command control function during track check and similar operations, set the PCCL pin high and input the desired general-purpose I/O ports commands (codes \$D9 through \$DF). (Only the general-purpose I/O port commands are accepted when the PCCL pin is high.) The PCCL pin must be set low to input a command other than a general-purpose I/O port command. However, if a track check or other command is applied when the PCCL pin is at the low level, the operation that is being performed will be interrupted. The state of the PCCL pin must only be changed when the RWC pin is low. However, it must not be changed during subcode Q readout.

Note: When track checking, if the same number of desired tracks as general-purpose I/O port commands (codes \$D9 to \$DF) is applied to with the PCCL held at 'L' level, general-purpose port command as well as track count operation for desired track count will be executed. Therefore, the desired tarack count data should not be set to the codes \$D9 to \$DF with the PCCL held at 'L' level when track checking.

LC78622NE

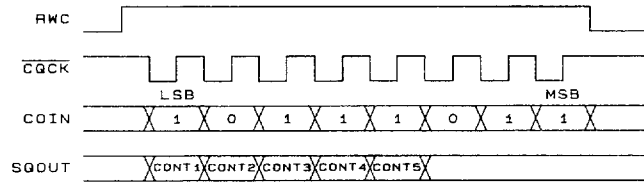

A05899

Additionally, CONT1 to CONT5 ports can be set up individually to function as control output pins with the PORT OP-E/D SET command. The ports are selected using the lower 5 bits of the 1Byte data. The bits in the data correspond to CONT1 to CONT5 in order starting with the LSB of the 1Byte data. This command is a Two- byte command. (RWC set once)

MSB	LSB	Command
1 1 0 1 1 0 1 1 X X X	d5 d4 d3 d2 d1	PORT OP-E/D SET

- dn = 1 ... Sets CONTn to be an output pin
- dn = 0 ... Sets CONTn to be an input pin
- X... don't care

Ports set to be output pins can output high or low levels independently. The 8 bits of the 1 Byte data correspond to those ports. The bits in the data correspond to CONT1 to CONT8 in order starting with the LSB of the 1 Byte data. To use CONT6 through CONT8 as output ports, the port functions must be set with the \$D9 and \$DE commands. This command is a two-byte command. (RWC set once)

MSB	LSB	Command
1 1 0 1 1 1 0 0 X X X	d5 d4 d3 d2 d1	PORT DATA SET

- dn = 1 ... Sets CONTn to be an output pin
- dn = 0 ... Sets CONTn to be an input pin
- X... don't care

20. Clock Oscillator; Pin 45: X_{IN}, pin 44: X_{OUT}

MSB	LSB	Command	RES = low
1 0 0 0 1 1 1 0		OSC ON	○
1 0 0 0 1 1 0 1		OSC OFF	
1 1 0 0 1 1 1 0		XTAL 16M	○
1 1 0 0 0 0 1 0		NORMAL-SPEED PLAYBACK	○
1 1 0 0 0 0 0 1		DOUBLE-SPEED PLAYBACK	

The clock that is used as the time base is generated by connecting a 16.9344 MHz oscillator element between these pins. The OSC OFF command turns off both the VCO and crystal oscillators. The system control microprocessor can issue double-speed or normal-speed playback command when the application implements double-speed playback system.

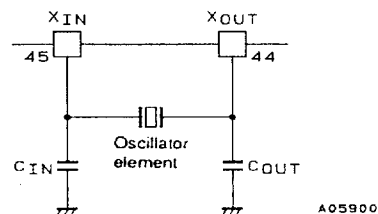

A05900

21. 16M and 4.2M Pins; Pin 60: 16M, pin 61: 4.2M

Both in normal- and double-speed playback modes, the 16M pin buffer outputs the 16.9344 MHz external crystal oscillator 16.9344 MHz signal. The 4.2M pin supplies the LA9240M or LA9241M system clock, normally outputting a 4.2336 MHz signal. When the oscillator is turned off both these pins will be fixed at either high or low.

LC78622NE

22. Reset Circuit; Pin 58: $\overline{\text{RES}}$

When power is first applied, this pin should be briefly set low and then set high. This will set the muting to $-\infty$ dB and stop the disk motor.

Constant linear velocity servo	START	<input type="checkbox"/> STOP	BRAKE	CLV
Muting control	0 dB	<input type="checkbox"/> $-\infty$		
Q subcode address conditions	<input type="checkbox"/> Address 1	Address free		
Track jump mode	<input type="checkbox"/> Standard	New		
Track count mode	Standard	<input type="checkbox"/> New		
Digital attenuator	<input type="checkbox"/> DATA 0	DATA 00H to EEH		
OSC	<input type="checkbox"/> ON	OFF		
Playback speed	<input type="checkbox"/> Normal speed	Double speed		
Digital filter normal speed	ON	<input type="checkbox"/> OFF		

Setting the $\overline{\text{RES}}$ pin low sets the LC78622NE to the settings enclosed in boxes in the table.

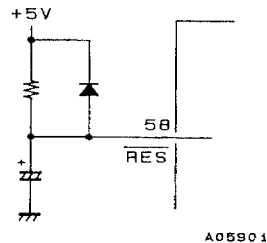

23. Other Pins; Pin 2: TAI, pin 64: TEST1, pin 11: TEST2, pin 32: TEST3, pin 33: TEST4, pin 62: TEST5, pin 59: TST11

These pins are used for testing the LSI's internal circuits. Even though pull-down resistors are built into the TAI and TEST2 to TEST5 input pin circuits, these pins must be connected to 0 V during normal operation. TST11 is an output pin and should normally be left open. Since TEST 1 is an input pin without a pull-down resistor built in, be sure to connect to 0V.

24. Circuit Block Operating Descriptions

• RAM address control

The LC78622NE incorporates an 8-bit × 2k-word RAM on chip. This RAM has an EFM demodulated data jitter handling capacity of ±4 frames implemented using address control. The LC78622NE continuously checks the remaining buffer capacity and controls the data write address to fall in the center of the buffer capacity by making fine adjustments to the frequency divisor in the PCK side of the CLV servo circuit. If the ±4 frame buffer capacity is exceeded, the LC78622NE forcibly sets the write address to the ±0 position. However, since the errors that occur due to this operation cannot be handled with error flag processing, the IC applies muting to the output for a 128 frame period.

Position	Division ratio or processing	
-4 or less	Force to ±0	
-3	589	Increase ratio
-2	589	
-1	589	
±0	588	Standard ratio
+1	587	Decrease ratio
+2	587	
+3	587	
+4 or more	Force to ±0	

• C1 and C2 Error Correction

The LC78622NE writes EFM demodulated data to internal RAM to compensate for jitter and then performs the following processing with uniform timing based on the crystal oscillator clock. First, the LC78622NE performs C1 error checking and correction in the C1 block, determines the C1 flags, and writes the C1 flag register. Next, the LC78622NE performs C2 error checking and correction in the C2 block, determines the C2 flags, and writes data to internal RAM.

C1 flag	Error correction and flag processing
No errors	No correction required · Flag reset
1 error	Correction · Flag reset
2 errors	Correction · Flag set
3 errors or more	Correction not possible · Flag set

C2 flag	Error correction and flag processing
No errors	No correction required · Flag reset
1 error	Correction · Flag reset
2 errors	Depends on C1 flags ¹
3 errors or more	Depends on C1 flags ²

- Note: 1. If the positions of the errors determined by the C2 check agree with those specified by the C1 flags, the correction is performed and the flags are cleared. However, if the number of C1 flags is 7 or higher, C2 correction may fail. In this case correction is not performed and the C1 flags are taken as the C2 flags without change. Error correction is not possible if one error position agrees and the other does not. Furthermore, if the number of C1 flags is 5 or under, the C1 check result can be seen as unreliable. Accordingly, the flags will be set in this case. Cases where the number of C1 flags is 6 or more are handled in the same way, and the C1 flags are taken as the C2 flags without change. When there is not even one agreement between the error positions, error correction is, of course, impossible. Here, if the number of C1 flags was 2 or under, data that was seen as correct after C1 correction is now seen as incorrect data. The flags are set in this case. In other cases, the C1 flags are taken as the C2 flags without change.
2. When data is determined to have three or more errors and be uncorrectable, correction is, of course, impossible. Here, if the number of C1 flags was 2 or under, data that was seen as correct after C1 correction is now seen as incorrect data. The flags are set in this case. In other

LC78622NE

25. Command Summary Table

Blank entry: Illegal command, #: Changed or added command, *: Latching commands (mode setting commands), ○: Commands shared with an ASP (LA9220M/30M/40M or other processor), Items in parentheses are ASP commands (provided for reference purposes)

00000000	(ADJ.reset)	00100000	* TOFF low in TJ mode	01000000	* UBIT ON	01100000	
00000001	* MUTE 0 dB	00100001	* TOFF high in TJ mode	01000001	* UBIT OFF	01100001	
00000010	#	00100010	* New TRACK COUNT	01000010	* DOUT ON	01100010	
00000011	* MUTE -∞ dB	00100011	* Old TRACK COUNT	01000011	* DOUT OFF	01100011	
00000100	* DISC MTR START	00100100		01000100		01100100	
00000101	* DISC MTR CLV	00100101		01000101		01100101	
00000110	* DISC MTR BRAKE	00100110		01000110		01100110	
00000111	* DISC MTR STOP	00100111		01000111		01100111	
00001000	○ FOCUS START #1	00101000	* STO CONT	01001000		01101000	
00001001	* ADDRESS FREE	00101001	* LCH CONT	01001001		01101001	
00001010	#	00101010	* RCH CONT	01001010		01101010	
00001011		00101011	#	01001011		01101011	#
00001100		00101100	#	01001100		01101100	#
00001101		00101101	#	01001101		01101101	
00001110	#	00101110	#	01001110		01101110	*DF normal speed off
00001111	* TRACKING OFF	00101111		01001111		01101111	#
00010000	2TJ IN	00110000	32TJ IN	01010000		01110000	
00010001	1TJ IN #1	00110001	1TJ IN #3	01010001		01110001	
00010010	1TJ IN #2	00110010		01010010	1TJ IN #4	01110010	
00010011	4TJ IN	00110011		01010011		01110011	
00010100	16TJ IN	00110100		01010100		01110100	
00010101	64TJ IN	00110101		01010101		01110101	
00010110	256TC	00110110		01010110		01110110	
00010111	128TJ IN	00110111		01010111		01110111	
00011000	2TJ OUT	00111000	32TJ OUT	01011000		01111000	
00011001	1TJ OUT #1	00111001	1TJ OUT #3	01011001		01111001	
00011010	1TJ OUT #2	00111010		01011010	1TJ OUT #4	01111010	
00011011	4TJ OUT	00111011		01011011		01111011	
00011100	16TJ OUT	00111100		01011100		01111100	
00011101	64TJ OUT	00111101		01011101		01111101	
00011110		00111110		01011110		01111110	
00011111	128TJ OUT	00111111		01011111		01111111	

Continued on next page.

LC78622NE

Continued from preceding page.

Blank entry: Illegal command, #: Changed or added command, *: Latching commands (mode setting commands), ○: Commands shared with an ASP (LA9240M/41M or other processor), Items in parentheses are ASP commands (provided for reference purposes)

10000000		10100000	* Old TRK JMP	11000000		11100000	
10000001	* ATT DATA SET	10100001	* New TRK JMP	11000001	* Double-speed playback	11100001	
10000010	* ATT 4STP UP	10100010	FOCUS START #2	11000010	* Normal-speed playback	11100010	
10000011	* ATT 4STP DWN	10100011	* Internal BRAKE CONT	11000011		11100011	
10000100	* ATT 8STP UP	10100100		11000100	* Internal BRK OFF	11100100	
10000101	* ATT 8STP DWN	10100101		11000101	* Internal BRK ON	11100101	
10000110	* ATT 16STP UP	10100110		11000110		11100110	
10000111	* ATT 16STP DWN	10100111		11000111		11100111	
10001000	* #CDROMXA	10101000	* DISC 8 SET	11001000	#	11101000	
10001001	* ADDRESS 1	10101001	* DISC 12 SET	11001001	*#	11101001	
10001010	#	10101010		11001010	* Internal BRK-DMC low	11101010	
10001011	* #ROMXA RST	10101011		11001011	* Internal BRK-DMC high	11101011	
10001100	TRACK JMP BRK	10101100		11001100	* TOFF during internal BRAKE	11101100	
10001101	* OSC OFF	10101101		11001101	* TON during internal BRAKE	11101101	
10001110	* OSC ON	10101110		11001110	* Xtal 16M	11101110	* Command noise rejecter OFF
10001111	* TRACKING ON	10101111		11001111		11101111	* Command noise rejecter ON
10010000	(* F.OFF.ADJ.ST)	10110000	* CLV-PH 1/1 mode	11010000		11110000	* ○ TRCK CHECK IN (2BYTE DETECT)
10010001	(* F.OFF.ADJ.OFF)	10110001	* CLV-PH 1/2 mode	11010001		11110001	
10010010	(* T.OFF.ADJ.ST)	10110010	* CLV-PH 1/4 mode	11010010		11110010	
10010011	(* T.OFF.ADJ.OFF)	10110011	* CLV-PH 1/8 mode	11010011		11110011	
10010100	(* LSR.ON)	10110100	* CLV3ST output ON	11010100		11110100	
10010101	(* LSR.OFF/SV.ON)	10110101	* CLV3ST output OFF	11010101		11110101	
10010110	(* LSR.OFF/SV.OFF)	10110110	* JP3ST output ON	11010110		11110110	
10010111	(* SP.8CM)	10110111	* JP3ST output OFF	11010111		11110111	
10011000	(* SP.12CM)	10111000		11011000		11111000	* ○ TRCK CHECK OUT (2BYTE DETECT)
10011001	(* SP.OFF)	10111001		11011001	#CONT6	11111001	
10011010	(* SLED.ON)	10111010		11011010	#EMPH	11111010	
10011011	(* SLED.OFF)	10111011		11011011	#PORT I/O SET	11111011	
10011100	(* EF.BAL.START)	10111100		11011100	#PORT OUTPUT SET	11111100	
10011101	(* T.SERVO.OFF)	10111101		11011101	#PORT READ	11111101	
10011110	(* T.SERVO.ON)	10111110		11011110	#CONT7, 8	11111110	○ NOTHING
10011111		10111111		11011111	#MUTEL, R	11111111	* ○ 2BYTE CMD RST

Note: VCO × 2 SET command should be issued in case of low voltage power supply application.

LC78622NE

26. Sample Application Circuit

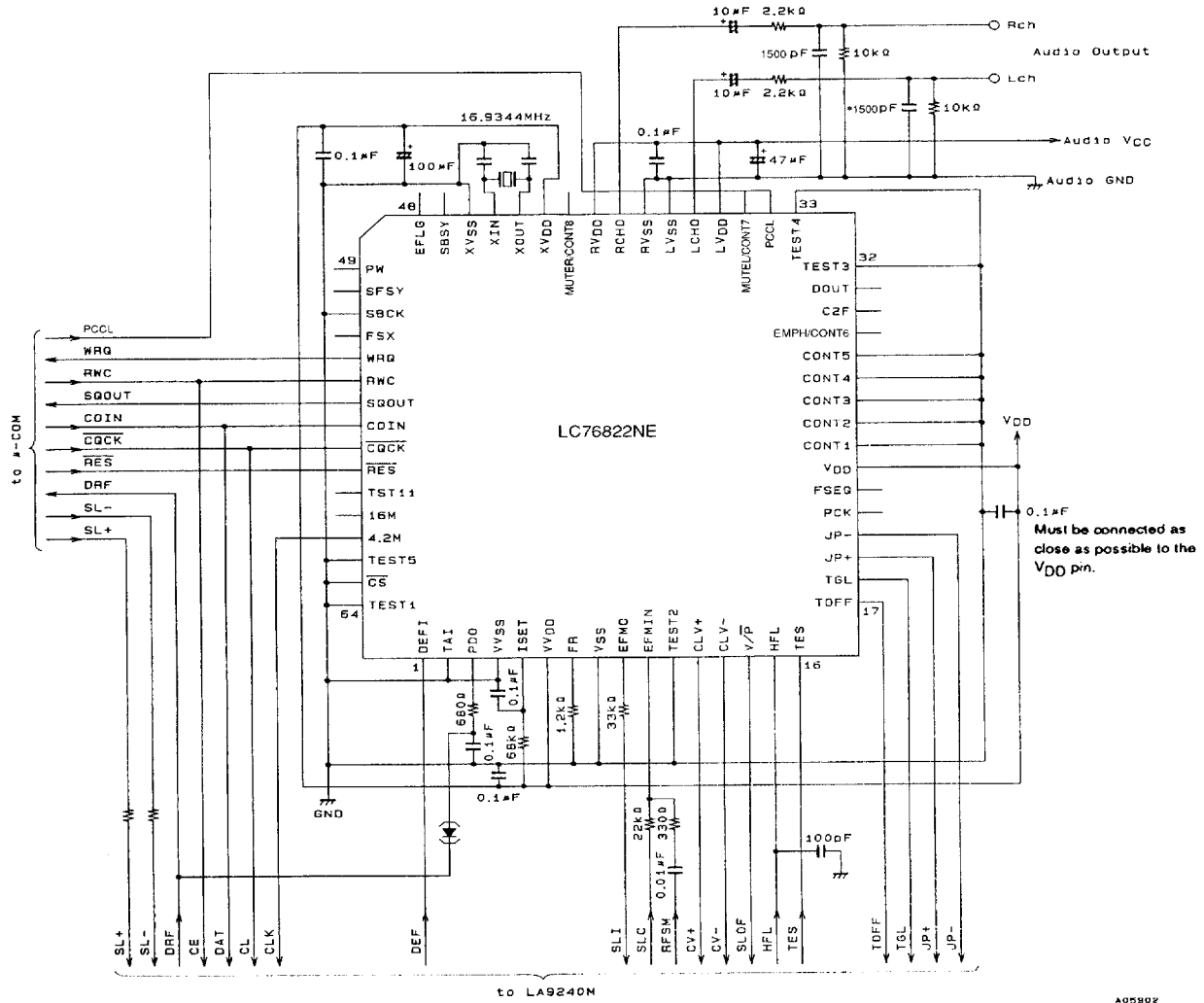

7997076 0021777 899

LC78622NE

27. CD-DSP Functional Comparison

Product		LC786021E	LC78625E	LC78630E	LC78624E	LC78626E (LC78626KE)	LC78622E	LC78622NE
Function		Built-in VCO FR = 1.2 K Ω	Built-in VCO FR = 1.2 K Ω	Built-in VCO FR = 1.2 K Ω	Built-in VCO FR = 1.2 K Ω	Built-in VCO FR = 5.1 K Ω	Built-in VCO FR = 1.2 K Ω	
RAM		16K	16K	18K	16K	16K	16K	16K
Playback speed		2X	2X	4X	2X	2X	2X	2X
Digital output		○	○	○	○	○	○	○
Interpolation		4	4	2	2	2	2	2
Zero-cross muting		○ -12 dB, $-\infty$	○ -12 dB, $-\infty$	○ $-\infty$	○ $-\infty$	○ $-\infty$	○ $-\infty$	○ $-\infty$
Level meter peak search		○	○	×	×	×	×	×
Bilingual		○	○	○	○	○	○	○
Digital attenuator		○	○	○	×	○	○	○
Digital filters		8fs	8fs	2fs	×	4fs (8fs)	4fs	8fs
Digital de-emphasis		○	○	○	×	○	○	○
General-purpose port	Output	2	2	2	×	×	×	(3)
	I/O	×	(4)	2 + (4)	5	1 + (3)	5	5
VCD support		×	○	○	×	×	×	×
Anti-shock interface		○	○	○	×	Not required	×	×
Anti-shock control		×	×	×	×	○ max 4MDRAM (max 16MDRAM)	×	×
CD text		×	×	×	○	×	×	×
CD-ROM interface		○	○	○	×	×	×	×
1-bit DAC		○	○	○	×	○	○	○
L.P.F		×	×	×	×	○	○	○
Supply voltage		3.6 to 5.5 V	3.0 to 5.5 V	3.6 to 5.5 V	3.0 to 5.5 V	3.0 to 5.5 V (3.0 to 3.6 V)	3.0 to 5.5 V	3.6 to 5.5 V
Package		QFP80E	QFP80E	QFP80E	QFP64E	QFP100E	QFP64E	QFP64E

Notes on Application Design

While it goes without saying that to achieve system reliability the absolute maximum ratings and allowable operating conditions specified for this IC must be strictly adhered to, adequate consideration must also be given to the operating environmental conditions, such as ambient temperature and static electricity, and to the mounting conditions used.

This section presents items that require special care during application design and IC mounting.

Handling of Unused Pins

- If unused input pins on this IC are left in the open state during IC operation, there are times when the IC may enter an unstable state. Always follow all the directions for handling unused pins included in the documentation for this IC. Also, do not connect any output pins to power supply, ground, or any other output lines.
- All general-purpose I/O ports must either be set to the output state and set to output a low level in software, or must be left in the input state and pulled up or pulled down to a fixed input level.

Latch-up Prevention

- Due to the structure of this IC, all supply voltage pins must be supplied with the same potential.
 - Also supply the same potential to the servo system ASP. The slice level control circuit is shared with this IC, and application of the same potential is necessary. Also, the same potential must be supplied to all supply voltage pins on the ASP IC.
- Latch-up may occur if any discrepancy occurs in the timing of the rise of the supply voltage applied to the different supply voltage pins. Do not allow timing discrepancies to occur when power is first applied.
- Do not allow the pin voltages on any of the input or output pins to exceed V_{DD} or to fall lower than V_{SS} . The timing of signal application requires special care at power on to assure that this condition is met.
- Do not allow overvoltages or abnormal noise to be applied to this IC.

continued on next page.

Continued from preceding page.

- In general, latch-up can be prevented by tying any unused pins to either V_{DD} or V_{SS} . However, be sure to follow any special instructions provided with this IC for unused pin handling.
- Do not short the outputs.

Interface

When the inputs and outputs of devices of different types are connected, incorrect operation may occur due to discrepancies between the input V_{IL}/V_{IH} and output V_{OL}/V_{OH} values. Insert level shifters between devices that have different supply voltages to prevent device destruction in systems that use dual power-supply systems.

Load Capacitance and Output Current

- When a load with a large capacitance is connected, since a load short that lasts for an extended period, fused output lines can be caused. Also, high charge and discharge currents can result in noise which can degrade end product performance or result in incorrect operation. Always use the recommended load capacitances.
- Large output sink or source currents can also cause the same types of problems described in the previous item. Use the recommended currents, while taking the maximum allowable power dissipation into account.

Notes on Power Application and Reset

- There are points that require care that are related to power application, the period during which a reset is applied, and the period after a reset is cleared. Refer to the specific notes provided in the specification sheets for the individual products, and design end products with these points in mind.
- The pin output states, the pin I/O settings, the contents of registers, and other aspects of this IC are not guaranteed when power is first applied. Aspects that are defined by the reset operation or by settings are only guaranteed once the reset or setting has been performed. Applications that use this IC should apply a reset immediately after power is applied. Pin states and register values that are undefined may differ between samples, and may change between lots over time. Applications should not depend on undefined states and values.
- The general-purpose I/O ports are set to the input state during a reset. For pins that must be fixed at high or low due to fail-safe design considerations, pulling up to V_{DD} or pulling down to V_{SS} through an individual resistor can be an effective design.
- When the 4.2MHz output is used as the microcontroller master clock, the reset circuit will be shared with the microcontroller. Since the microcontroller will not be reset unless a clock signal is applied, do not control the reset input to this IC from a microcontroller output port. If this IC has not been reset, the 4.2-MHz output is not guaranteed, and the microcontroller may not be reset. This can result in incorrect application system operation.

Notes on Thermal Design

The failure rate of semiconductor devices is significantly accelerated by increases in ambient temperature and power dissipation. To assure high reliability, designs must include adequate margins to take possible changes in ambient conditions into account.

Notes on Printed Circuit Board Patterns

- If possible, the influence of common impedances should be reduced by separating the V_{DD} and ground lines for each system.
- The V_{DD} and ground lines should be as wide and as short as possible to lower their high-frequency impedance. Ideally, decoupling capacitors (0.01 to 1 μF) should be inserted between each V_{DD} and ground pair. These capacitors should be located extremely close to their corresponding power supply system pins. Additionally, it is appropriate to insert a capacitor of about 100 to 220 μF between V_{DD} and ground as a low-frequency filter. However, note that using excessively large capacitors here can result in latch-up.
 - In servo systems, the V_{REF} lines should be handled in the same manner as the V_{CC} and ground lines. Driver ground lines should be particularly wide, and the recommended driver pattern should be used direct under the power devices taking heat radiation effect into consideration.
 - If a current output type pickup is used, locate the optical sensor connector and the ASP RF input as close together as possible. If a voltage output type pickup is used, locate the I/V conversion resistor as close to the ASP RF input side as possible.

Continued on next page.

Continued from preceding page.

- EFM signal lines should be kept as short as possible, and either adjacent lines should be avoided or V_{DD} or ground shield lines should be run between adjacent EFM signal lines.
Since the slice level controller output (EFMO) and the ASP clock output (4.2MHz) lines can easily disrupt EFM signal lines, resistors connected to output pins should be located extremely close to the pin. Note that the smaller these resistors, the larger the amount of spurious radiation emitted. Inversely, the output level may be adversely influenced if the resistors are made too large. Design the 4.2MHz output according to the ASP input level requirements. (Design center: 1 V p-p)
- Noise on the microcontroller interface signal lines can result in incorrect operation. While the best method for reducing noise depends on the application itself, in general, the interface lines should be made as short as possible and inductances and capacitances minimized. However, designs must also take crosstalk into account.
If long interface lines must be used, or if noise is a problem, inserting a noise exclusion circuit may be effective. Design noise filters with the interface timing taken into account. Issuing the command noise reduction command [\$EF] may also be effective.
- Cover the area around the crystal oscillator element with the ground pattern.

Notes on Software Design

- Always follow the recommendations for software design provided in the IC documentation and do not use any techniques specifically forbidden.
- If the digital outputs are used, issue a UBIT OFF [\$41] command to this IC during initialization. UBIT ON [\$40] should only be used during playback to prevent DIR unlock and incorrect subcode recognition.
- During initialization, after clearing an IC reset, and after turning this IC's oscillator on, issue a 2-byte reset command [\$FF] to the LA9230M Series or LA9240M Series ASP to set up the ASP command register.
- Since the LA9230M Series and LA9240M Series ASP ICs use the 4.2MHz output from this IC as their master clock, an additional 30 ms of setup time is required after the oscillator stabilization time during initialization, after clearing an IC reset, and after turning this IC's oscillator on. This 30 ms of setup time is also required after issuing an ASP reset command [\$00] to the ASP.
- Since the command timing for the LA9230M Series and LA9240M Series ASP ICs is slower than that for this IC, be sure to refer to the ASP IC documentation when designing application software.

Other Notes

If you have any questions, please do not hesitate to contact your Sanyo representative, or your Sanyo semiconductor sales outlet.

Since this IC is specifically designed for use in CD players, its specifications differ from those of standard logic and other general-purpose IC products. We recommend adopting failsafe design techniques in the applications, and we also recommend debugging applications in the application equipment itself.