

SIPMOS® Power Transistor

- N channel
- Enhancement mode
- Avalanche-rated
- dv/dt rated
- 175°C operating temperature

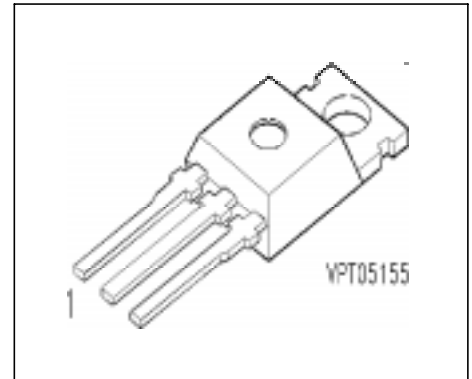

Pin 1	Pin 2	Pin 3
G	D	S

Type	V_{DS}	I_D	$R_{DS(on)}$	Package	Ordering Code
BUZ 101 S	55 V	22 A	0.06 Ω	TO-220 AB	Q67040-S4013-A2

Maximum Ratings

Parameter	Symbol	Values	Unit
Continuous drain current	I_D		A
$T_C = 25\text{ }^\circ\text{C}$		22	
$T_C = 100\text{ }^\circ\text{C}$		16	
Pulsed drain current	I_{Dpuls}		
$T_C = 25\text{ }^\circ\text{C}$		88	
Avalanche energy, single pulse	E_{AS}		mJ
$I_D = 22\text{ A}$, $V_{DD} = 25\text{ V}$, $R_{GS} = 25\text{ }^\circ\Omega$			
$L = 372\text{ }^\circ\mu\text{H}$, $T_j = 25\text{ }^\circ\text{C}$		90	
Avalanche current, limited by T_{jmax}	I_{AR}	22	A
Avalanche energy, periodic limited by T_{jmax}	E_{AR}	5.5	mJ
Reverse diode dv/dt	dv/dt		kV/ μs
$I_S = 22\text{ A}$, $V_{DS} = 40\text{ V}$, $di_F/dt = 200\text{ A}/\mu\text{s}$			
$T_{jmax} = 175\text{ }^\circ\text{C}$		6	
Gate source voltage	V_{GS}	± 20	V
Power dissipation	P_{tot}		W
$T_C = 25\text{ }^\circ\text{C}$		55	

Maximum Ratings

Parameter	Symbol	Values	Unit
Operating temperature	T_j	-55 ... + 175	°C
Storage temperature	T_{stg}	-55 ... + 175	
Thermal resistance, junction - case	R_{thJC}	≤ 2.7	K/W
Thermal resistance, junction - ambient	R_{thJA}	≤ 62	
IEC climatic category, DIN IEC 68-1		55 / 175 / 56	

Electrical Characteristics, at $T_j = 25^\circ\text{C}$, unless otherwise specified

Parameter	Symbol	Values			Unit
		min.	typ.	max.	

Static Characteristics

Drain- source breakdown voltage $V_{GS} = 0 \text{ V}, I_D = 0.25 \text{ mA}, T_j = 25 \text{ }^\circ\text{C}$	$V_{(BR)DSS}$	55	-	-	V
Gate threshold voltage $V_{GS}=V_{DS}, I_D = 40 \text{ }\mu\text{A}$	$V_{GS(th)}$	2.1	3	4	
Zero gate voltage drain current $V_{DS} = 50 \text{ V}, V_{GS} = 0 \text{ V}, T_j = -40 \text{ }^\circ\text{C}$ $V_{DS} = 50 \text{ V}, V_{GS} = 0 \text{ V}, T_j = 25 \text{ }^\circ\text{C}$ $V_{DS} = 50 \text{ V}, V_{GS} = 0 \text{ V}, T_j = 150 \text{ }^\circ\text{C}$	I_{DSS}	-	-	0.1 1 100	μA
Gate-source leakage current $V_{GS} = 20 \text{ V}, V_{DS} = 0 \text{ V}$	I_{GSS}	-	10	100	
Drain-Source on-resistance $V_{GS} = 10 \text{ V}, I_D = 16 \text{ A}$	$R_{DS(on)}$	-	0.04	0.06	

Electrical Characteristics, at $T_j = 25^\circ\text{C}$, unless otherwise specified

Parameter	Symbol	Values			Unit
		min.	typ.	max.	
Dynamic Characteristics					
Transconductance $V_{DS} \geq 2 \cdot I_D \cdot R_{DS(on)max}$, $I_D = 16 \text{ A}$	g_{fs}	7	-	-	S
Input capacitance $V_{GS} = 0 \text{ V}$, $V_{DS} = 25 \text{ V}$, $f = 1 \text{ MHz}$	C_{iss}	-	490	615	pF
Output capacitance $V_{GS} = 0 \text{ V}$, $V_{DS} = 25 \text{ V}$, $f = 1 \text{ MHz}$	C_{oss}	-	170	215	
Reverse transfer capacitance $V_{GS} = 0 \text{ V}$, $V_{DS} = 25 \text{ V}$, $f = 1 \text{ MHz}$	C_{rss}	-	95	120	
Turn-on delay time $V_{DD} = 30 \text{ V}$, $V_{GS} = 10 \text{ V}$, $I_D = 22 \text{ A}$ $R_G = 19.6 \Omega$	$t_{d(on)}$	-	10	15	ns
Rise time $V_{DD} = 30 \text{ V}$, $V_{GS} = 10 \text{ V}$, $I_D = 22 \text{ A}$ $R_G = 19.6 \Omega$	t_r	-	25	38	
Turn-off delay time $V_{DD} = 30 \text{ V}$, $V_{GS} = 10 \text{ V}$, $I_D = 22 \text{ A}$ $R_G = 19.6 \Omega$	$t_{d(off)}$	-	20	30	
Fall time $V_{DD} = 30 \text{ V}$, $V_{GS} = 10 \text{ V}$, $I_D = 22 \text{ A}$ $R_G = 19.6 \Omega$	t_f	-	20	30	
Gate charge at threshold $V_{DD} = 40 \text{ V}$, $I_D = 0.1 \text{ A}$, $V_{GS} = 0 \text{ to } 1 \text{ V}$	$Q_{g(th)}$	-	0.5	0.75	nC
Gate charge at 7.0 V $V_{DD} = 40 \text{ V}$, $I_D = 22 \text{ A}$, $V_{GS} = 0 \text{ to } 7 \text{ V}$	$Q_{g(7)}$	-	13	20	
Gate charge total $V_{DD} = 40 \text{ V}$, $I_D = 22 \text{ A}$, $V_{GS} = 0 \text{ to } 10 \text{ V}$	$Q_{g(total)}$	-	17	26	
Gate plateau voltage $V_{DD} = 40 \text{ V}$, $I_D = 22 \text{ A}$	$V_{(plateau)}$	-	5.9	-	V

Electrical Characteristics, at $T_j = 25^\circ\text{C}$, unless otherwise specified

Parameter	Symbol	Values			Unit
		min.	typ.	max.	
Reverse Diode					
Inverse diode continuous forward current $T_C = 25^\circ\text{C}$	I_S	-	-	22	A
Inverse diode direct current, pulsed $T_C = 25^\circ\text{C}$	I_{SM}	-	-	88	
Inverse diode forward voltage $V_{GS} = 0\text{ V}, I_F = 44\text{ A}$	V_{SD}	-	1.2	1.8	V
Reverse recovery time $V_R = 30\text{ V}, I_F = I_S, di_F/dt = 100\text{ A}/\mu\text{s}$	t_{rr}	-	55	85	ns
Reverse recovery charge $V_R = 30\text{ V}, I_F = I_S, di_F/dt = 100\text{ A}/\mu\text{s}$	Q_{rr}	-	0.12	0.18	μC

Power dissipation

$$P_{\text{tot}} = f(T_C)$$

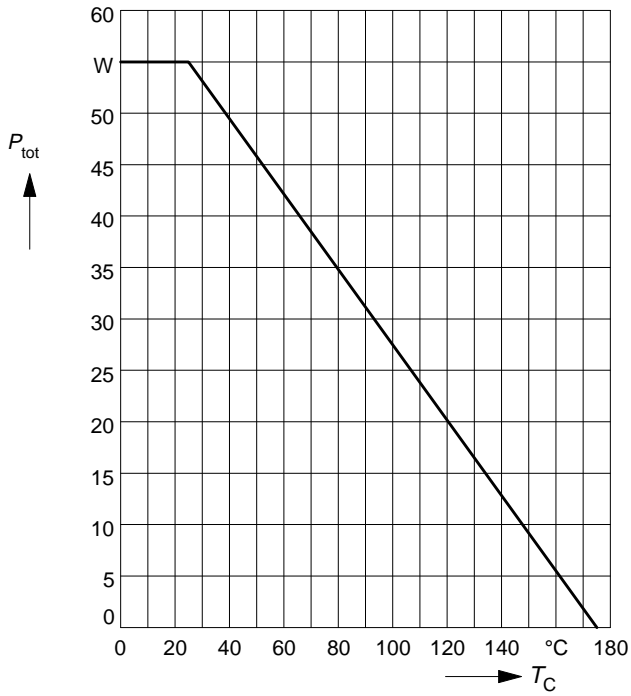

Drain current

$$I_D = f(T_C)$$

parameter: $V_{GS} \geq 10 \text{ V}$

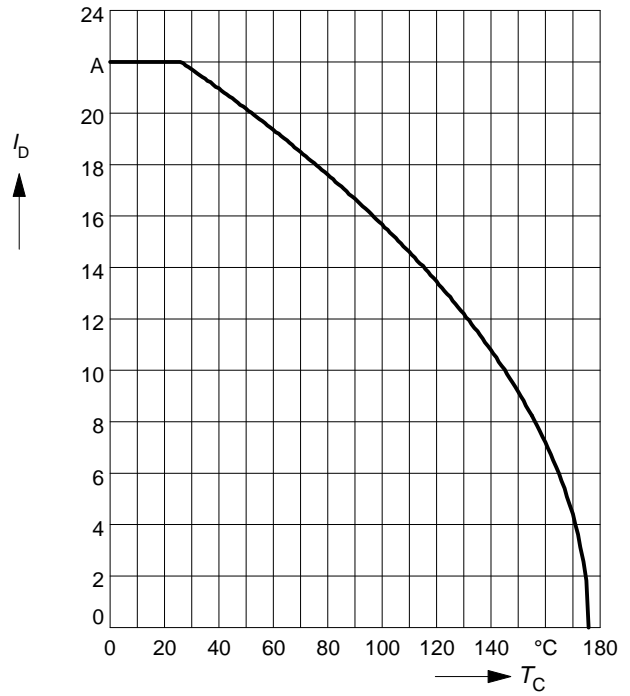

Typ. output characteristics

$$I_D = f(V_{DS})$$

parameter: $t_p = 80 \mu s$

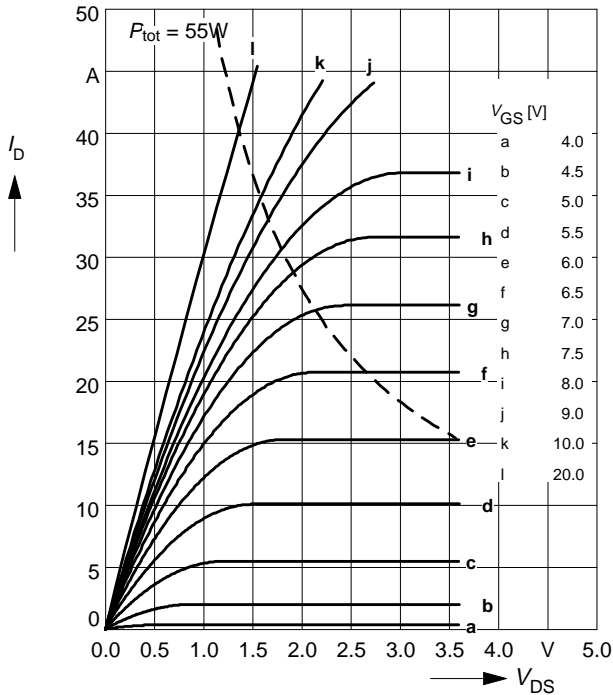

Typ. drain-source on-resistance

$$R_{DS(on)} = f(I_D)$$

parameter: $t_p = 80 \mu s, T_j = 25^\circ C$

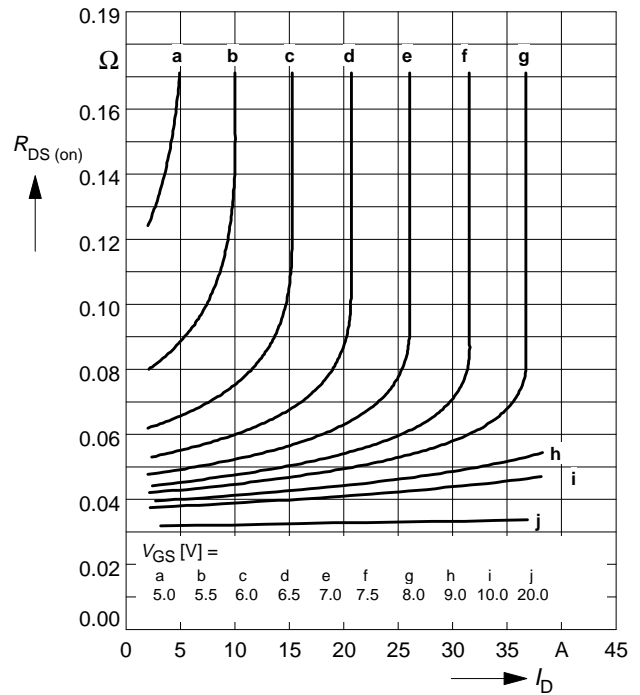

Typ. transfer characteristics $I_D = f(V_{GS})$

parameter: $t_p = 80 \mu s$

$$V_{DS} \geq 2 \times I_D \times R_{DS(on)max}$$

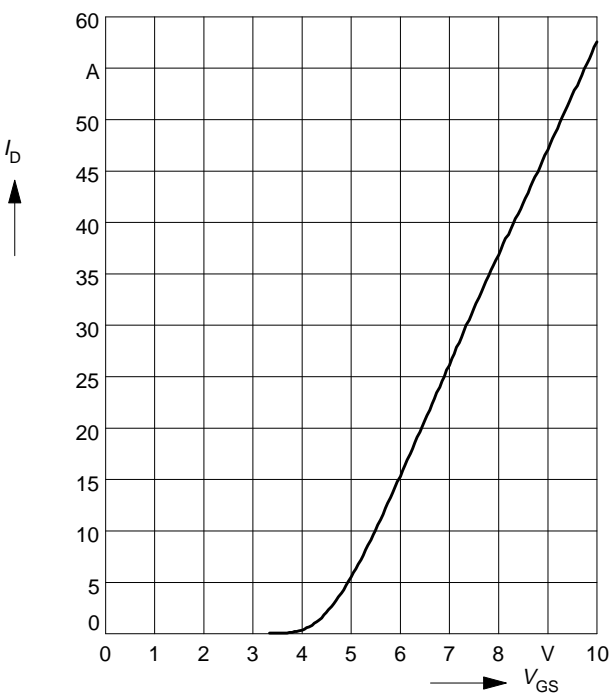

Drain-source on-resistance

$$R_{DS(on)} = f(T_j)$$

parameter: $I_D = 16\text{ A}$, $V_{GS} = 10\text{ V}$

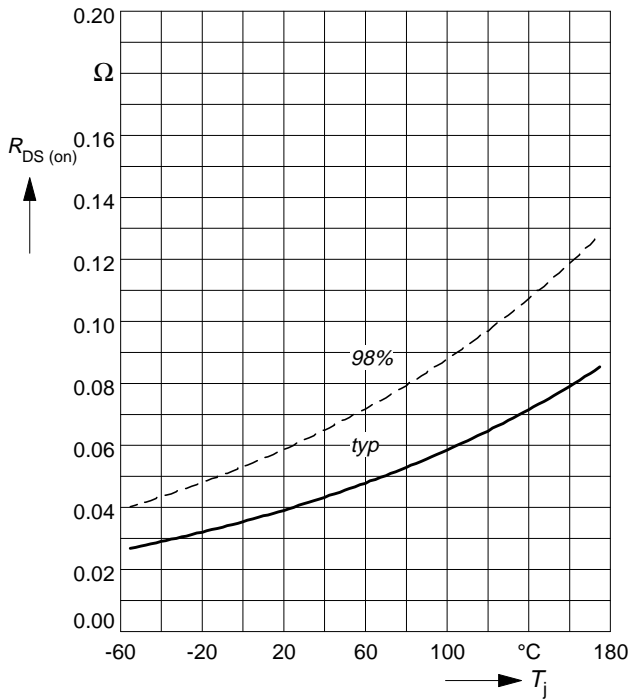

Gate threshold voltage

$$V_{GS(th)} = f(T_j)$$

parameter: $V_{GS} = V_{DS}$, $I_D = 40\text{ }\mu\text{A}$

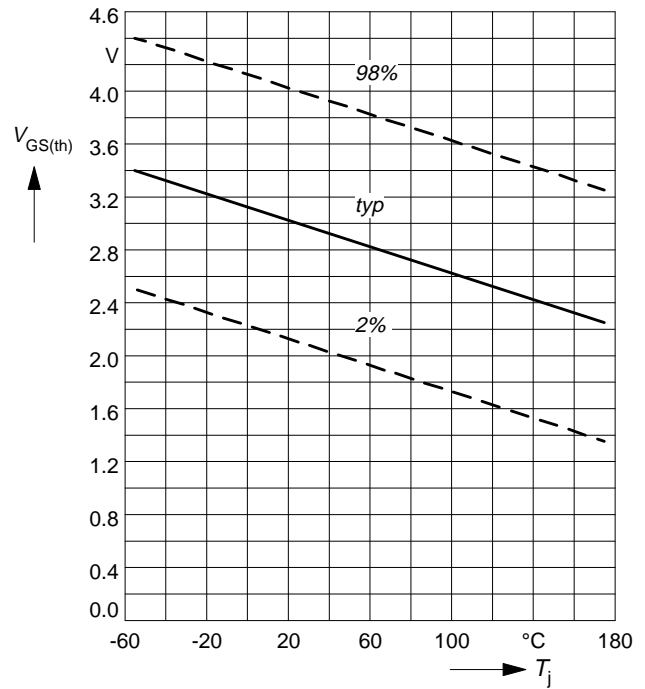

Typ. capacitances

$$C = f(V_{DS})$$

parameter: $V_{GS} = 0\text{ V}$, $f = 1\text{ MHz}$

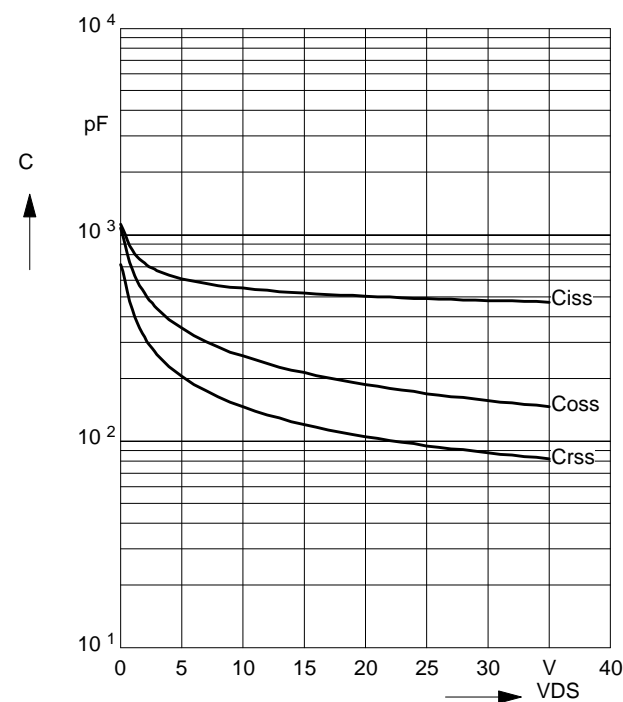

Forward characteristics of reverse diode

$$I_F = f(V_{SD})$$

parameter: T_j , $t_p = 80\text{ }\mu\text{s}$

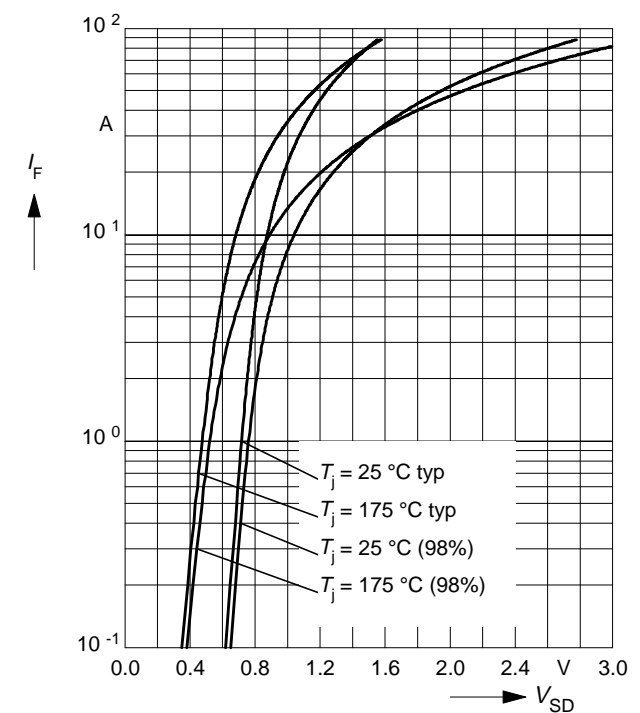

Avalanche energy $E_{AS} = f(T_j)$

parameter: $I_D = 22A, V_{DD} = 25V$

$R_{GS} = 25\ \Omega, L = 372\ \mu H$

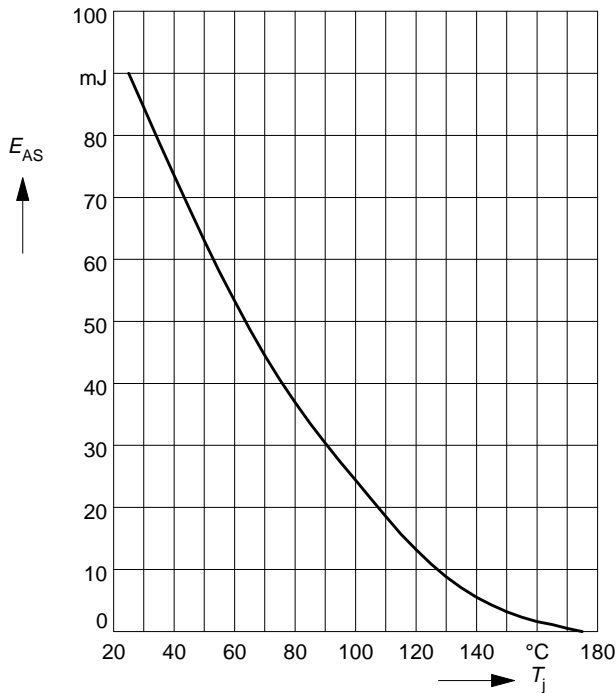

Typ. gate charge

$V_{GS} = f(Q_{Gate})$

parameter: $I_{D\ puls} = 22A$

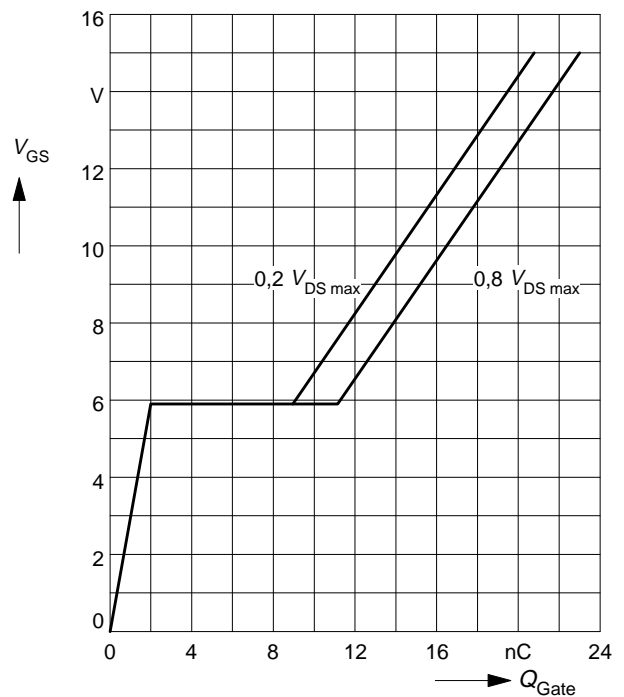

Drain-source breakdown voltage

$V_{(BR)DSS} = f(T_j)$

