



DUAL DECADE COUNTER

The SN54/74LS490 contains a pair of high-speed 4-stage ripple counters. Each half of the SN54/74LS490 has individual Clock, Master Reset and Master Set (Preset 9) inputs. Each section counts in the 8, 4, 2, 1 BCD code.

- Dual Version of SN54/74LS490
- Individual Asynchronous Clear and Preset to 9 for Each Counter
- Count Frequency — Typically 65 MHz
- Input Clamp Diodes Limit High-Speed Termination Effects

CONNECTION DIAGRAM DIP (TOP VIEW)

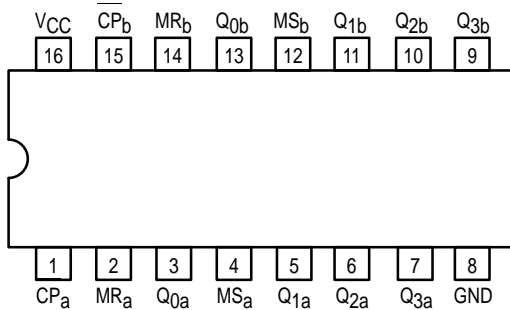

PIN NAMES

- MS Master Set (Set to 9) Input
- MR Master Reset
- CP Clock Input (Active LOW Going Edge)
- Q₀–Q₃ Counter Outputs (Note b)

LOADING (Note a)

	HIGH	LOW
MS	0.5 U.L.	0.25 U.L.
MR	0.5 U.L.	0.25 U.L.
CP	1.5 U.L.	1.5 U.L.
Q ₀ –Q ₃	10 U.L.	5 (2.5) U.L.

NOTES:

- a) 1 TTL Unit Load (U.L.) = 40 μA HIGH/1.6 mA LOW.
- b) The Output LOW drive factor is 2.5 U.L. for Military (54) and 5 U.L. for Commercial (74) Temperature Ranges.

LOGIC DIAGRAM (ONE HALF SHOWN)

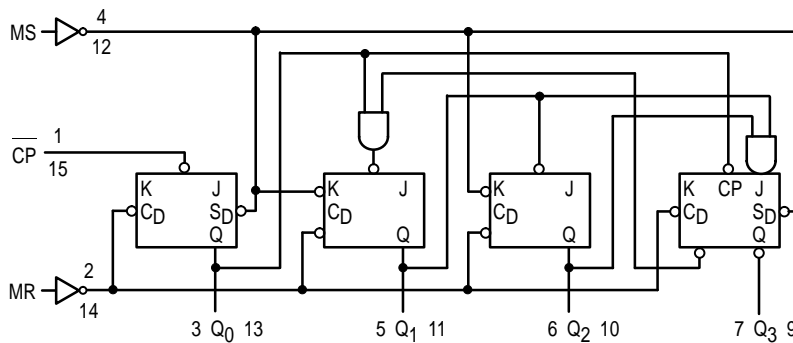

SN54/74LS490

DUAL DECADE COUNTER

LOW POWER SCHOTTKY

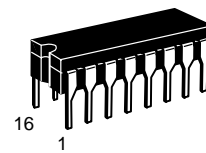

J SUFFIX
CERAMIC
CASE 620-09

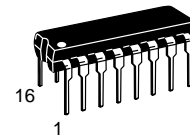

N SUFFIX
PLASTIC
CASE 648-08

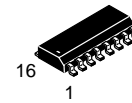

D SUFFIX
SOIC
CASE 751B-03

ORDERING INFORMATION

- SN54LSXXXJ Ceramic
- SN74LSXXXN Plastic
- SN74LSXXXD SOIC

TRUTH TABLE

COUNT	OUTPUTS			
	Q ₃	Q ₂	Q ₁	Q ₀
0	L	L	L	L
1	L	L	L	H
2	L	L	H	L
3	L	L	H	H
4	L	H	L	L
5	L	H	L	H
6	L	H	H	L
7	L	H	H	H
8	H	L	L	L
9	H	L	L	H

SN54/74LS490

GUARANTEED OPERATING RANGES

Symbol	Parameter		Min	Typ	Max	Unit
V _{CC}	Supply Voltage	54 74	4.5 4.75	5.0 5.0	5.5 5.25	V
T _A	Operating Ambient Temperature Range	54 74	-55 0	25 25	125 70	°C
I _{OH}	Output Current — High	54, 74			-0.4	mA
I _{OL}	Output Current — Low	54 74			4.0 8.0	mA

DC CHARACTERISTICS OVER OPERATING TEMPERATURE RANGE (unless otherwise specified)

Symbol	Parameter	Limits			Unit	Test Conditions	
		Min	Typ	Max			
V _{IH}	Input HIGH Voltage	2.0			V	Guaranteed Input HIGH Voltage for All Inputs	
V _{IL}	Input LOW Voltage	54		0.7	V	Guaranteed Input LOW Voltage for All Inputs	
		74		0.8			
V _{IK}	Input Clamp Diode Voltage		-0.65	-1.5	V	V _{CC} = MIN, I _{IN} = -18 mA	
V _{OH}	Output HIGH Voltage	54	2.5	3.5	V	V _{CC} = MIN, I _{OH} = MAX, V _{IN} = V _{IH} or V _{IL} per Truth Table	
		74	2.7	3.5	V		
V _{OL}	Output LOW Voltage	54, 74		0.25	0.4	V	I _{OL} = 4.0 mA
		74		0.35	0.5	V	I _{OL} = 8.0 mA
I _{IH}	Input HIGH Current			20	μA	V _{CC} = MAX, V _{IN} = 2.7 V	
				0.1	mA	V _{CC} = MAX, V _{IN} = 7.0 V	
I _{IL}	Input LOW Current	MS, MR		-0.4	mA	V _{CC} = MAX, V _{IN} = 0.4 V	
		Clock		-1.6			
I _{OS}	Short Circuit Current (Note 1)	-20		-100	mA	V _{CC} = MAX	
I _{CC}	Power Supply Current			26	mA	V _{CC} = MAX	

Note 1: Not more than one output should be shorted at a time, nor for more than 1 second.

AC SET-UP REQUIREMENTS (T_A = 25°C, V_{CC} = 5.0 V)

Symbol	Parameter	Limits			Unit	Test Conditions
		Min	Typ	Max		
t _W	Any Pulse Width	20			ns	V _{CC} = 5.0 V
t _S	MR or MS to Setup Time	25			ns	

SN54/74LS490

AC CHARACTERISTICS (T_A = 25°C)

Symbol	Parameter	Limits			Unit	Test Conditions
		Min	Typ	Max		
f _{MAX}	Maximum Clock Frequency	25	35		MHz	Figure 1
t _{PLH} t _{PHL}	Propagation Delay, $\overline{\text{CP}}$ to Q ₀		12 13	20 20	ns	Figure 1
t _{PLH} t _{PHL}	Propagation Delay, $\overline{\text{CP}}$ to Q ₁ or Q ₃		24 26	39 39	ns	Figure 3
t _{PLH} t _{PHL}	Propagation Delay, $\overline{\text{CP}}$ to Q ₂		32 36	54 54	ns	Figure 2
t _{PHL}	Propagation Delay, MR to Output		24	39	ns	Figure 2
t _{PLH} t _{PHL}	Propagation Delay, MS to Output		24 20	39 36	ns	Figure 2

V_{CC} = 5.0 V,
C_L = 15 pF

AC WAVEFORMS

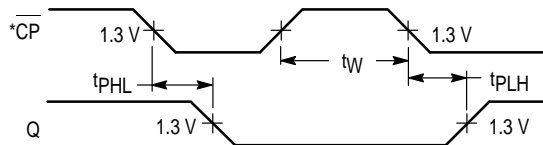

Figure 1

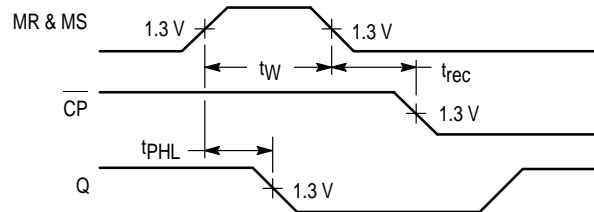

Figure 2

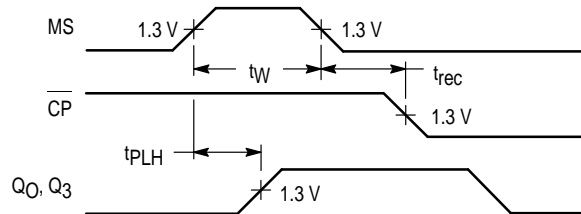

Figure 3

*The number of Clock Pulses required between the t_{PHL} and t_{PLH} measurements can be determined from the Truth Table.