



No. 5485

LC665304A, 665306A, 665308A, 665312A, 665316A

Four-Bit Single-Chip Microcontrollers with 4, 6, 8, 12, and 16 KB of On-Chip ROM

Preliminary

Overview

The LC665304A, LC665306A, LC665308A, LC665312A, and LC665316A are 4-bit CMOS microcontrollers that integrate on a single chip all the functions required in a system controller, including ROM, RAM, I/O ports, a serial interface, 16-value comparator inputs, timers, interrupt functions, and an optional sub-oscillator circuit. These microcontrollers are available in a 48-pin package.

Features and Functions

- On-chip ROM capacity of 4, 6, 8, 12, and 16 kilobytes, and an on-chip RAM capacity of 512×4 bits.
- Fully supports the LC66000 Series common instruction set (128 instructions).
- I/O ports: 42 pins
- A sub-oscillator circuit can be used (option)
This circuit allows power dissipation to be reduced by operating at lower speeds.
- 8-bit serial interface: two circuits (can be connected in cascade to form a 16-bit interface)
- Instruction cycle time: 0.95 to 10 μs (at 3 to 5.5 V)
- Powerful timer functions and prescalers.
 - Time limit timer, event counter, pulse width measurement, and square wave output using a 12-bit timer.
 - Time limit timer, event counter, PWM output, and square wave output using an 8-bit timer.
 - Time base function using a 12-bit prescaler.
- Powerful interrupt system with 8 interrupt factors and 8 interrupt vector locations.
 - External interrupts: 3 factors/3 vector locations
 - Internal interrupts: 5 factors/5 vector locations
- Flexible I/O functions
16-value comparator inputs, 20-mA drive outputs, inverter circuits, pull-up and open-drain circuits selectable as options.
- Optional runaway detection function (watchdog timer)
- 8-bit I/O functions
- Power saving functions using halt and hold modes.
- Packages: DIP48S, QIP48E (QFP48E)

- Evaluation LSIs: LC66599 (evaluation chip) + EVA800/850-TB662YXX2
LC66E5316(on-chip EPROM microcontroller)

Package Dimensions

unit: mm

3149-DIP48S

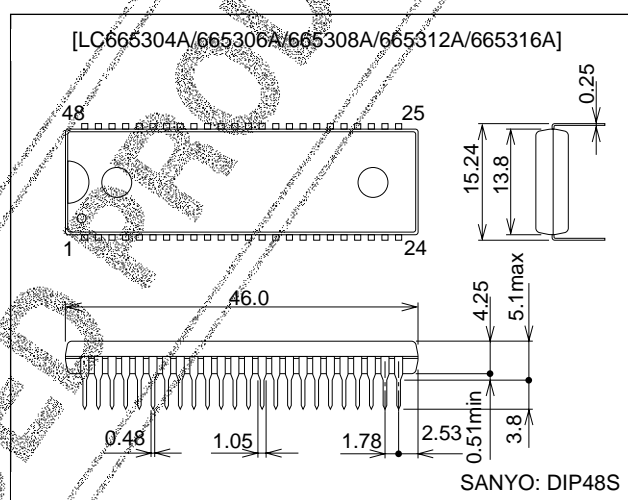

unit: mm

3156-QFP48E

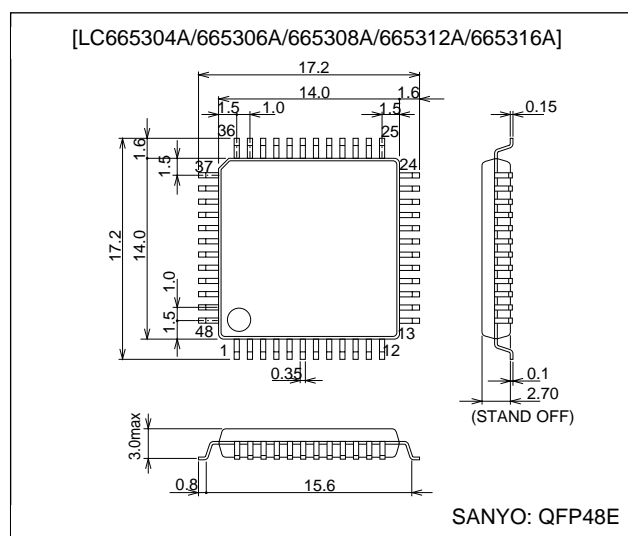

SANYO Electric Co., Ltd. Semiconductor Business Headquarters

TOKYO OFFICE Tokyo Bldg., 1-10, 1 Chome, Ueno, Taito-ku, TOKYO, 110 JAPAN

22897HA (OT) No. 5485-1/26

Series Organization

Type No.	No. of pins	ROM capacity	RAM capacity	Package		Features
LC66304A/306A/308A	42	4 K/6 K/8 KB	512 W	DIP42S	QFP48E	Normal versions 4.0 to 6.0 V/0.92 µs
LC66404A/406A/408A	42	4 K/6 K/8 KB	512 W	DIP42S	QFP48E	
LC66506B/508B/512B/516B	64	6 K/8 K/12 K/16 KB	512 W	DIP64S	QFP64A	
LC66354A/356A/358A	42	4 K/6 K/8 KB	512 W	DIP42S	QFP48E	Low-voltage versions 2.2 to 5.5 V/3.92 µs
LC66354S/356S/358S	42	4 K/6 K/8 KB	512 W		QFP44M	
LC66556A/558A/562A/566A	64	6 K/8 K/12 K/16 KB	512 W	DIP64S	QFP64E	Low-voltage high-speed versions 3.0 to 5.5 V/0.92 µs
LC66354B/356B/358B	42	4 K/6 K/8 KB	512 W	DIP42S	QFP48E	
LC66556B/558B/562B/566B	64	6 K/8 K/12 K/16 KB	512 W	DIP64S	QFP64E	
LC66354C/356C/358C	42	4 K/6 K/8 KB	512 W	DIP42S	QFP48E	2.5 to 5.5 V/0.92 µs
LC662104A/06A/08A	30	4 K/6 K/8 KB	384 W	DIP30SD	MFP30S	On-chip DTMF generator versions 3.0 to 5.5 V/0.95 µs
LC662304A/06A/08A/12A/16A	42	4 K/6 K/8 K/12 K/16 KB	512 W	DIP42S	QFP48E	
LC662508A/12A/16A	64	8 K/12 K/16 KB	512 W	DIP64S	QFP64E	
LC665304A/06A/08A/12A/16A	48	4 K/6 K/8 K/12 K/16 KB	512 W	DIP48S	QFP48E	Dual oscillator support 3.0 to 5.5 V/0.95 µs
LC66E308	42	EPROM 8 KB	512 W	DIC42S with window	QFC48 with window	Window and OTP evaluation versions 4.5 to 5.5 V/0.92 µs
LC66P308	42	OTPROM 8 KB	512 W	DIP42S	QFP48E	
LC66E408	42	EPROM 8 KB	512 W	DIC42S with window	QFC48 with window	
LC66P408	42	OTPROM 8 KB	512 W	DIP42S	QFP48E	
LC66E516	64	EPROM 16 KB	512 W	DIC64S with window	QFC64 with window	
LC66P516	64	OTPROM 16 KB	512 W	DIP64S	QFP64E	
LC66E2108*	30	EPROM 8 KB	384 W			Window evaluation versions 4.5 to 5.5 V/0.92 µs
LC66E2316	42	EPROM 16 KB	512 W	DIC42S with window	QFC48 with window	
LC66E2516	64	EPROM 16 KB	512 W	DIC64S with window	QFC64 with window	
LC66E5316	52/48	EPROM 16 KB	512 W	DIC52S with window	QFC48 with window	OTP 4.0 to 5.5 V/0.95 µs
LC66P2108*	30	OTPROM 8 KB	384 W	DIP30SD	MFP30S	
LC66P2316*	42	OTPROM 16 KB	512 W	DIP42S	QFP48E	
LC66P2516	64	OTPROM 16 KB	512 W	DIP64S	QFP64E	
LC66P5316	48	OTPROM 16 KB	512 W	DIP48S	QFP48E	

Note: * Under development

DISCONTINUED

Pin Assignments

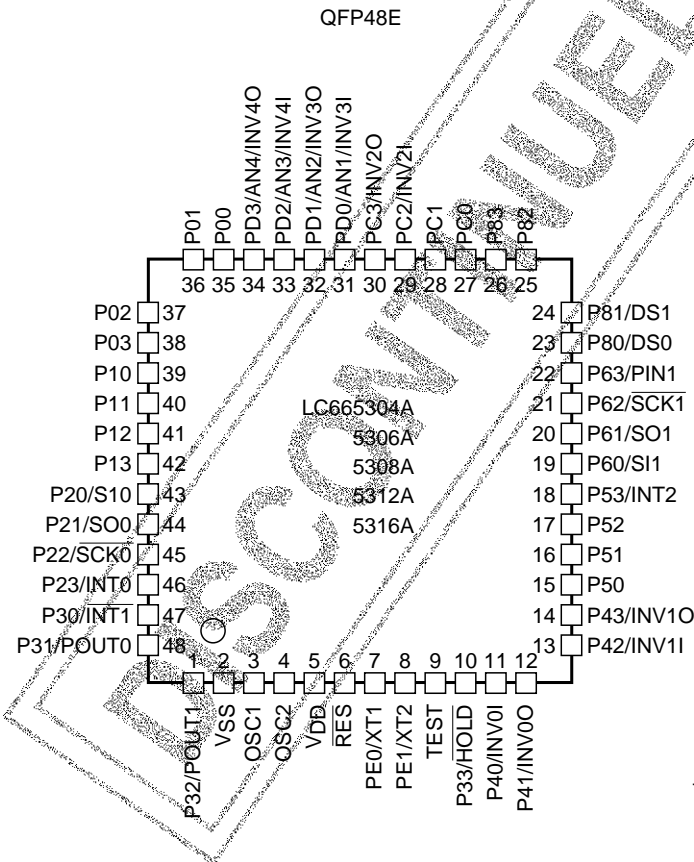
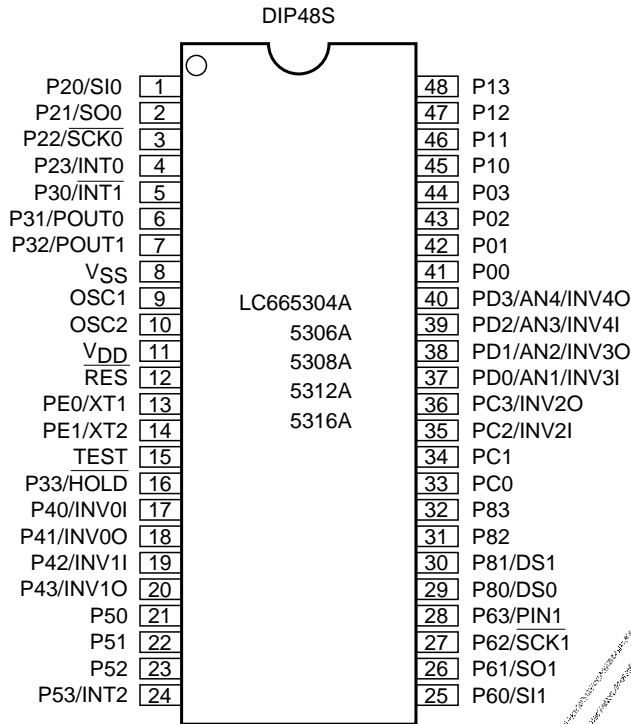

We recommend the use of reflow soldering techniques to solder-mount QFP packages.

Please consult with your Sanyo representative for details on process conditions if the package itself is to be directly immersed in a dip-soldering bath (dip-soldering techniques).

System Block Diagram

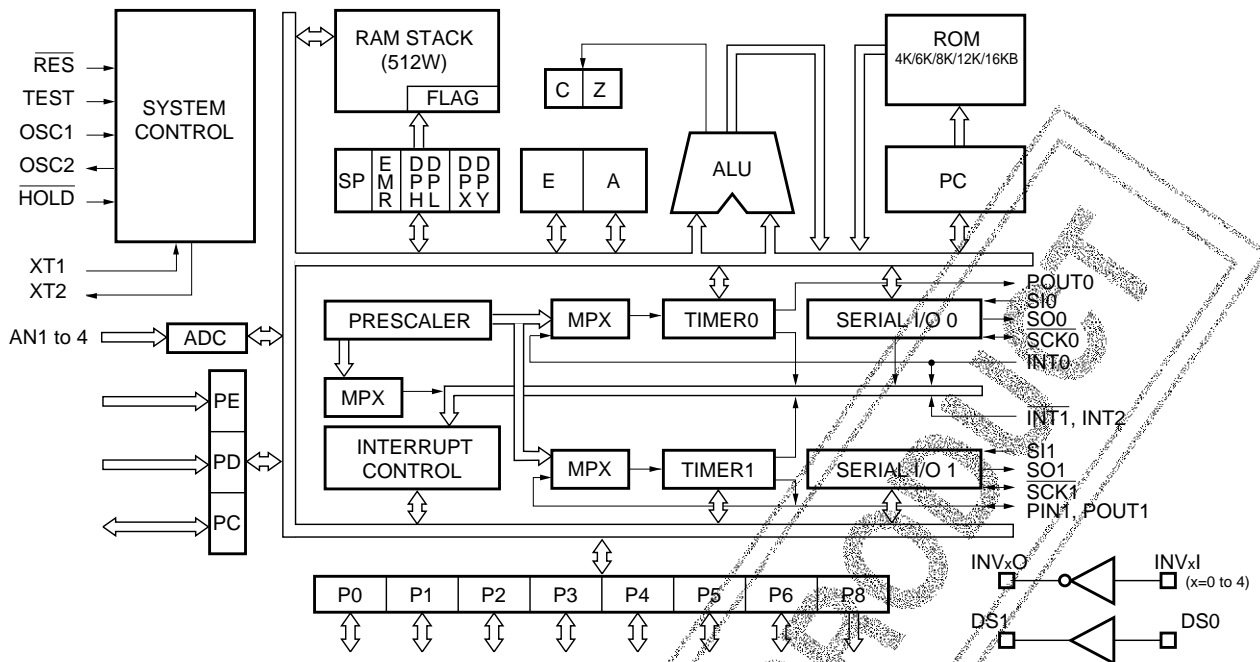

Differences between the LC6653XX Series and the LC663XX Series

Item	LC6630X Series (Including the LC66599 evaluation chip)	LC6635XB Series	LC6653XX Series
System differences	65536 cycles • Hardware wait time (number of cycles) when hold mode is cleared About 64 ms at 4 MHz (T _{cyc} = 1 μs)	16384 cycles About 16 ms at 4 MHz (T _{cyc} = 1 μs)	16384 cycles About 16 ms at 4 MHz (T _{cyc} = 1 μs)
• Value of timer 0 after a reset (Including the value after hold mode is cleared)	Set to FF0.	Set to FFC.	Set to FFC.
• Inverter array	None (Tools are handled with external devices.)	None	Yes
• Buffer array (data shaper circuit)	None (Tools are handled with external devices.)	None	Yes
• Sub-oscillator	None	None	Yes (option)
• Three-value inputs/comparator inputs	Yes	Yes	Only a 16-value comparator
• Three-state output from P31 and P32	None	None	Yes
• Using P0 to clear halt mode	In 4-bit groups	In 4-bit groups	Can be specified for each bit.
• External extended interrupts	None for INT3, INT4, and INT5. (Tools are handled with external devices.)	None for INT3, INT4, and INT5.	None for INT3, INT4, and INT5.
• Other P53 functions	Shared with INT2 (Tools are handled with external devices.)	Shared with INT2	Shared with INT2 (The logic is inverted.)
Differences in main characteristics	• LC66304A/306A/308A 4.0 to 6.0 V/0.92 to 10 μs • LC66E308/P308 4.5 to 5.5 V/0.92 to 10 μs	• 3.0 to 5.5 V/0.92 to 10 μs • LC6635XA 2.2 to 5.5 V/3.92 to 10 μs 3.0 to 5.5 V/1.96 to 10 μs	• 3.0 to 5.5 V/0.95 to 10 μs (When the main oscillator is operating) • 3.0 to 5.5 V/25 to 127 μs (When the sub-oscillator is operating)
• Operating power-supply voltage and operating speed (cycle time)			
• Pull-up resistors	P0, P1, P4, and P5: about 3 to 10 k	P0, P1, P4, and P5: about 3 to 10 k	P0, P1, P4, and P5: about 100 k
• Port voltage handling	• P2 to P6 and PC: 15-V handling • P0, P1, PD, PE: Normal voltage handling	• P2 to P6 and PC: 15-V handling • P0, P1, PD, PE: Normal voltage handling	All ports: normal voltage handling (7-V handling provided)

For other differences and details, see the data sheets for the individual products.

Pin Function Overview

Pin	I/O	Overview	Output driver type	Options	State after a reset	Standby mode operation
P00 P01 P02 P03	I/O	I/O ports P00 to P03 <ul style="list-style-type: none"> Input or output in 4-bit or 1-bit units P00 to P03 support the halt mode control function. (This function can be specified in bit units.) 	<ul style="list-style-type: none"> Pch: Pull-up MOS type Nch: Intermediate sink current type 	<ul style="list-style-type: none"> Pull-up MOS or Nch OD output Output level on reset 	High or low (option)	Hold mode: Output off Halt mode: Output retained
P10 P11 P12 P13	I/O	I/O ports P10 to P13 Input or output in 4-bit or 1-bit units	<ul style="list-style-type: none"> Pch: Pull-up MOS type Nch: Intermediate sink current type 	<ul style="list-style-type: none"> Pull-up MOS or Nch OD output Output level on reset 	High or low (option)	Hold mode: Output off Halt mode: Output retained
P20/SI0 P21/SO0 P22/SCK0 P23/INT0	I/O	I/O ports P20 to P23 <ul style="list-style-type: none"> Input or output in 4-bit or 1-bit units P20 is also used as the serial input SI0 pin. P21 is also used as the serial output SO0 pin. P22 is also used as the serial clock SCK0 pin. P23 is also used as the INT0 interrupt request pin, and also as the timer 0 event counting and pulse width measurement input. 	<ul style="list-style-type: none"> Pch: CMOS type Nch: Intermediate sink current type Nch: +7-V handling when OD option selected 	CMOS or Nch OD output	H	Hold mode: Output off Halt mode: Output retained
P30/INT1 P31/POUT0 P32/POUT1	I/O	I/O ports P30 to P32 <ul style="list-style-type: none"> Input or output in 3-bit or 1-bit units P30 is also used as the INT1 interrupt request. P31 is also used for the square wave output from timer 0. P32 is also used for the square wave and PWM output from timer 1. P31 and P32 also support 3-state outputs. 	<ul style="list-style-type: none"> Pch: CMOS type Nch: Intermediate sink current type Nch: +7-V handling when OD option selected 	CMOS or Nch OD output	H	Hold mode: Output off Halt mode: Output retained
P33/HOLD	I	Hold mode control input <ul style="list-style-type: none"> Hold mode is set up by the HOLD instruction when HOLD is low. In hold mode, the CPU is restarted by setting HOLD to the high level. This pin can be used as input port P33 along with P30 to P32. When the P33/HOLD pin is at the low level, the CPU will not be reset by a low level on the RES pin. Therefore, applications must not set P33/HOLD low when power is first applied. 				
P40/INV0I P41/INV0Q P42/INV1I P43/INV1O	I/O	I/O ports P40 to P43 <ul style="list-style-type: none"> Input or output in 4-bit or 1-bit units Input or output in 8-bit units when used in conjunction with P50 to P53. Can be used for output of 8-bit ROM data when used in conjunction with P50 to P53. Dedicated inverter circuit (option) 	<ul style="list-style-type: none"> Pch: Pull-up MOS type CMOS type when the inverter circuit option is selected Nch: Intermediate sink current type 	<ul style="list-style-type: none"> Pull-up MOS or Nch OD output Output level on reset Inverter circuit 	High or low or inverter I/O (option)	Hold mode: Port output off, inverter output off Halt mode: Port output retained, inverter output continues

Continued on next page.

Pin	I/O	Overview	Output driver type	Options	State after a reset	Standby mode operation
P50 P51 P52 P53/INT2	I/O	I/O ports P50 to P53 <ul style="list-style-type: none"> Input or output in 4-bit or 1-bit units Input or output in 8-bit units when used in conjunction with P40 to P43. Can be used for output of 8-bit ROM data when used in conjunction with P40 to P43. P53 is also used as the INT2 interrupt request. 	<ul style="list-style-type: none"> Pch: Pull-up MOS type Nch: Intermediate sink current type 	<ul style="list-style-type: none"> Pull-up MOS or Nch OD output Output level on reset 	High or low (option)	Hold mode: Output off Halt mode: Output retained.
P60/SI1 P61/SO1 P62/SCK1 P63/PIN1	I/O	I/O ports P60 to P63 <ul style="list-style-type: none"> Input or output in 4-bit or 1-bit units P60 is also used as the serial input SI1 pin. P61 is also used as the serial output SO1 pin. P62 is also used as the serial clock SCK1 pin. P63 is also used for the event count input to timer 1. 	<ul style="list-style-type: none"> Pch: MOS type Nch: Intermediate sink current type Nch: +7-V handling when OD option selected (P61 and P63 only) 	<ul style="list-style-type: none"> CMOS or Nch OD output 	H	Hold mode: Output off Halt mode: Output retained
P80/DS0 P81/DS1 P82 P83	O	Dedicated output ports P80 to P83 <ul style="list-style-type: none"> Output in 4-bit or 1-bit units The contents of the output latch are input using input instructions. P80 is a buffer input or a zero-cross buffer input and P81 is a buffer input (options). 	<ul style="list-style-type: none"> Pch: CMOS type Nch: Intermediate sink current type 	<ul style="list-style-type: none"> CMOS or Pch OD output Output level at reset Buffer circuit Zero-cross detector buffer circuit 	High or low Buffered I/O (option)	Hold mode: Port output off, buffer output off Halt mode: Port output retained, buffer output continues with the buffer resistor off.
PC0 PC1 PC2/INV2I PC3/INV2O	I/O	I/O ports PC0 to PC3 <ul style="list-style-type: none"> Output in 4-bit or 1-bit units Dedicated inverter circuits (option) 	<ul style="list-style-type: none"> Pch: CMOS type Nch: Intermediate sink current type 	<ul style="list-style-type: none"> CMOS or Nch OD output Inverter circuit 	H	Hold mode: Port output off, inverter output off Halt mode: Port output retained, inverter output continues.
PD0/AN1/ INV3I PD1/AN2/ INV3O PD2/AN3 INV4I PD3/AN4/ INV4O	I	Dedicated input ports PD0 to PD3 <ul style="list-style-type: none"> Can be switched in software to function as 16-value analog inputs Dedicated inverter circuits (option) 	<ul style="list-style-type: none"> Inverter circuits can be selected as options. Pch: CMOS type Nch: Intermediate sink current type 	Inverter circuit	Normal input or inverter I/O (option)	Inverter: <ul style="list-style-type: none"> Hold mode: Output off Halt mode: Output continues
PE0/XT1 PE1/XT2	I	Dedicated input ports and sub-oscillator connections		Sub-oscillator/port PE selection	Selected as an option	Sub-oscillator: Hold mode: Oscillator stopped Halt mode: Oscillator operates

Continued on next page.

Continued from preceding page.

Pin	I/O	Overview	Output driver type	Options	State after a reset	Standby mode operation
OSC1	I	System clock oscillator connections When an external clock is used, leave OSC2 open and connect the clock signal to OSC1.		Ceramic oscillator or external clock selection	Selected as an option	Hold mode: Oscillator stopped
OSC2	O					Halt mode: Oscillator operates
$\overline{\text{RES}}$	I	System reset input When the P33/HOLD pin is at the high level, a low level input to the RES pin will initialize the CPU.				
TEST	I	CPU test pin This pin must be connected to V_{SS} during normal operation.				
V_{DD} V_{SS}		Power supply pins				

Note: Pull-up MOS type: The output circuit includes a MOS transistor that pulls the pin up to V_{DD} .
CMOS output: Complementary output.
OD output: Open-drain output.

User Options

1. Port 0, 1, 4, 5, and 8 output level at reset option

The output levels at reset for I/O ports 0, 1, 4, 5, and 8, in independent 4-bit groups, can be selected from the following two options.

Option	Conditions and notes
1. Output high at reset	The four bits of ports 0, 1, 4, 5, or 8 are set in a group
2. Output low at reset	The four bits of ports 0, 1, 4, 5, or 8 are set in a group

2. Oscillator circuit options

• Main clock

Option	Circuit	Conditions and notes
1. External clock		The input has Schmitt characteristics
2. Ceramic oscillator		

Note: There is no RC oscillator option.

• Sub-clock

Option	Circuit	Conditions and notes
1. Ports PE0 and PE1		
2 Sub-oscillator (crystal oscillator)		

3. Watchdog timer option

A runaway detection function (watchdog timer) can be selected as an option.

4. Port output type options

- The output type of each bit (pin) in ports P0, P1, P2, P3 (except for the P33/ $\overline{\text{HOLD}}$ pin), P4, P5, P6, and PC can be selected individually from the following two options.

Option	Circuit	Conditions and notes
1. Open-drain output		The port P2, P3, P5, and P6 inputs have Schmitt characteristics.
2. Output with built-in pull-up resistor		The port P2, P3, P5, and P6 inputs have Schmitt characteristics. The CMOS outputs (ports P2, P3, P6, and PC) and the pull-up MOS outputs (P0, P1, P4, and P5) are distinguished by the drive capacity of the p-channel transistor.

- One of the following two options can be selected for P8, in bit units

Option	Circuit	Conditions and notes
1. Open-drain output		
2. Output with built-in pull-down resistor (CMOS output)		

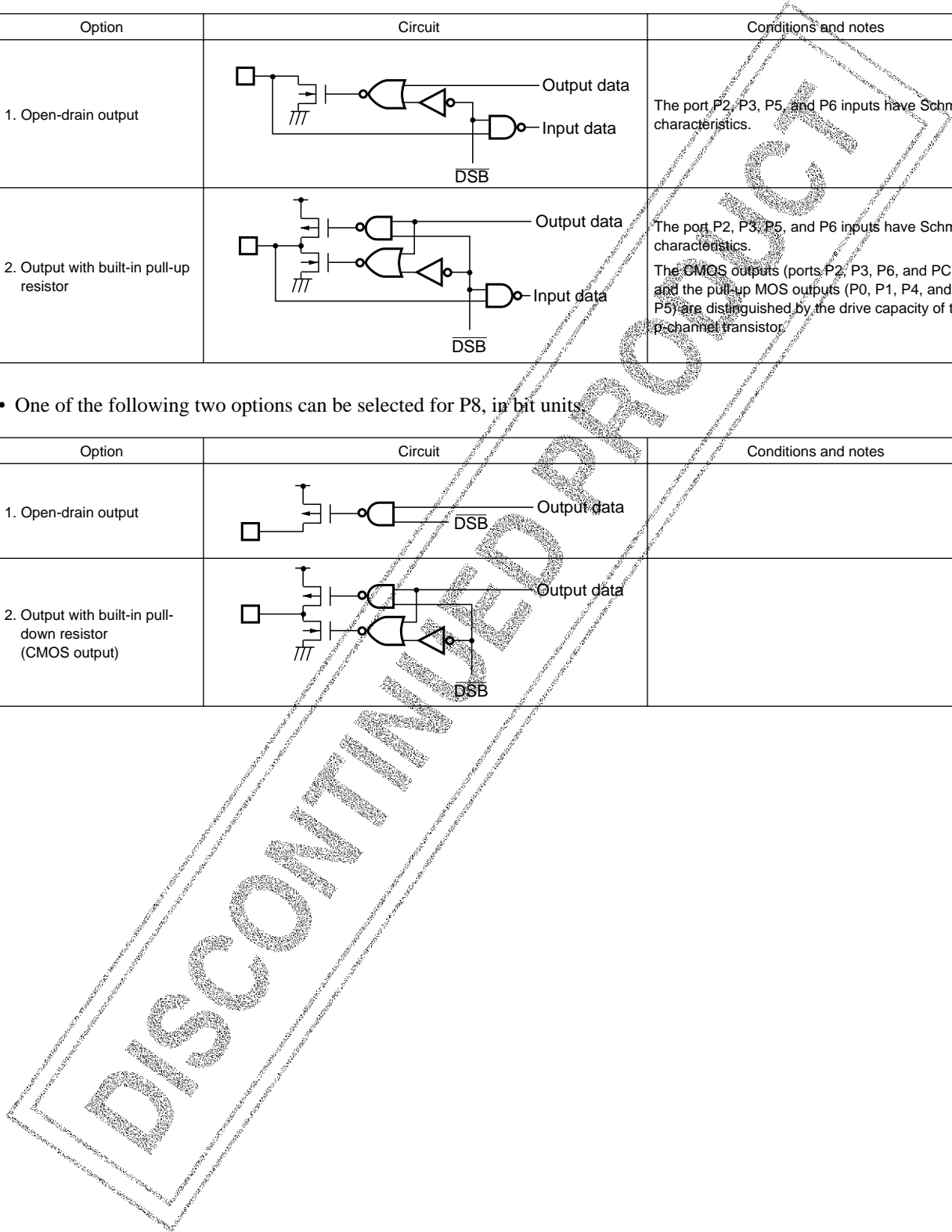

5. Inverter array circuit option

One of the following options can be selected for each of the following port sets: P40/P41, P42/P43, PC2/PC3, PD0/PD1, and PD2/PD3. (PDs do not use option 1 because they are dedicated to inputs)

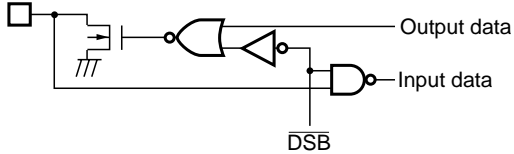
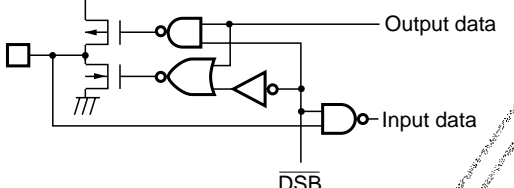
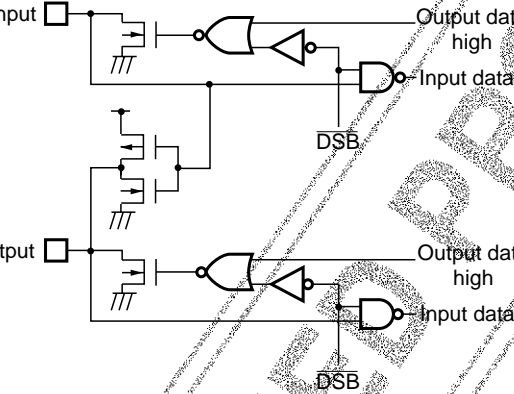
Option	Circuit	Conditions and notes
1. Normal port I/O circuit		<p>When the open-drain output type is selected</p>
		<p>When the built-in pull-up resistor output type is selected The CMOS outputs (PC) and the pull-up MOS outputs (R4) are distinguished by the drive capacity of the p-channel transistor.</p>
2. Inverter I/O circuit		<p>If this option is selected, The I/O circuit is disabled by the \overline{DSB} signal. Also note that the open-drain port output type option and the high level at reset option must be selected.</p>

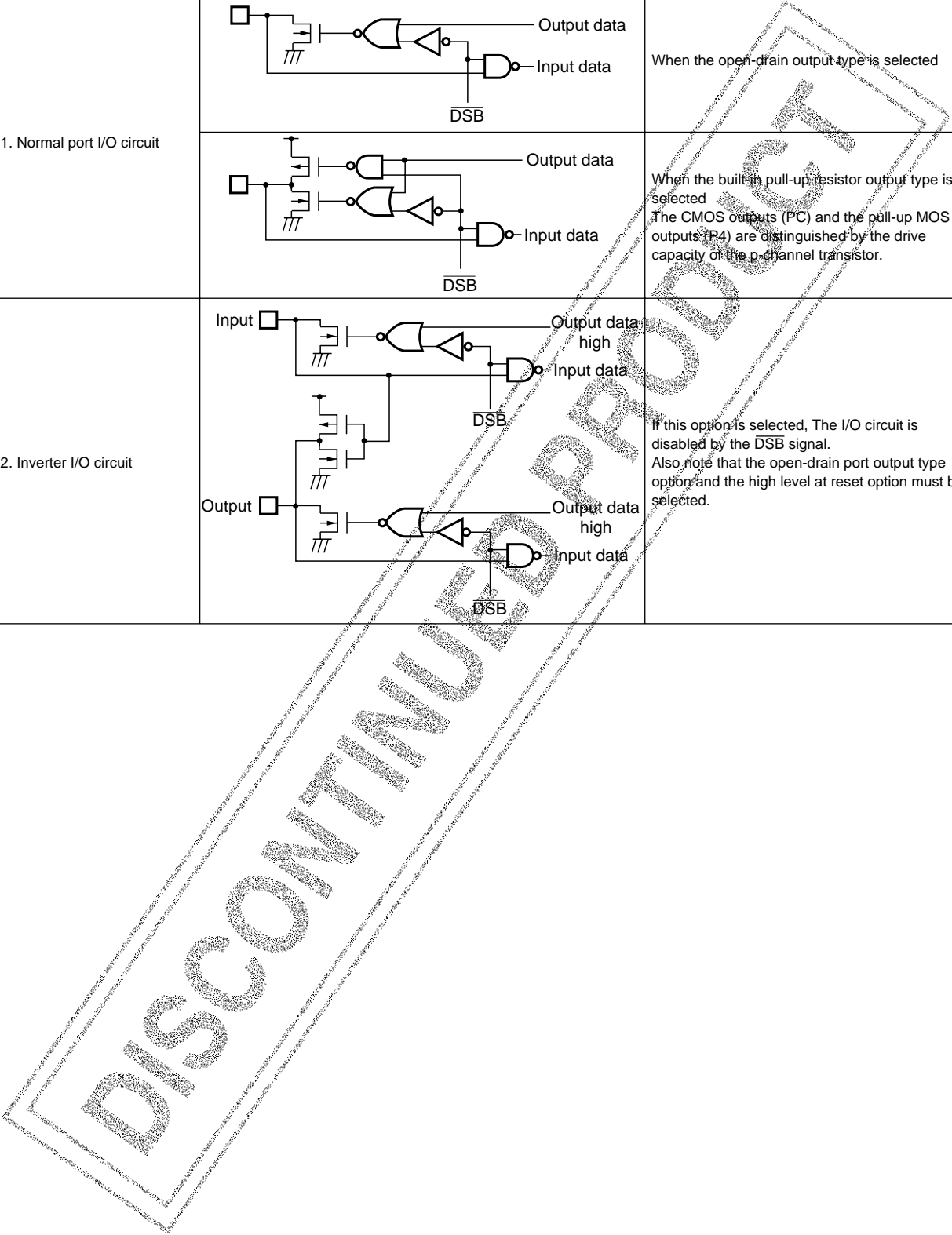

6. Buffer array circuit option

In addition to normal port output, one of the following two options may also be selected for P80 and P81.

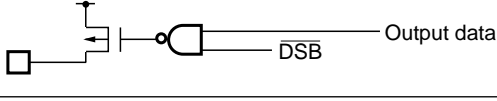
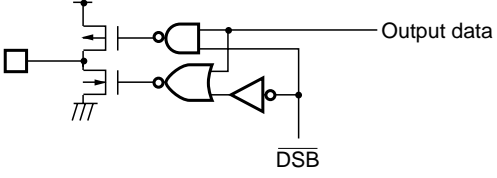
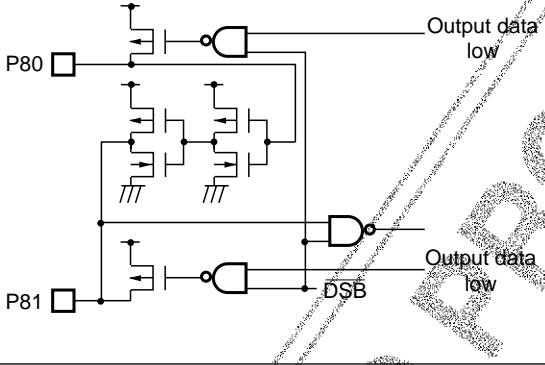
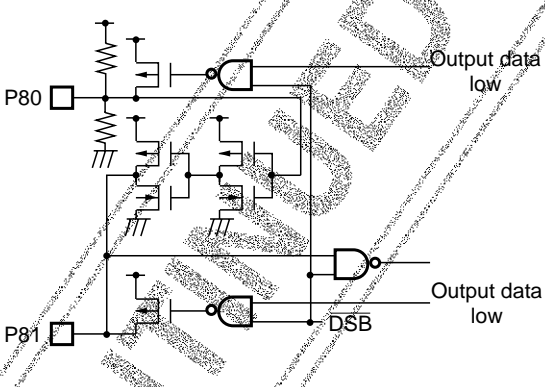
Option	Circuit	Conditions and notes
<p>1. Normal port output</p>		<p>When the open-drain output type is selected</p>
		<p>When the built-in pull-down resistor output type is selected (CMOS output)</p>
<p>2. Buffer input (P80) and buffer output (P81) circuits</p>		<p>If this option is selected, the I/O circuit is disabled by the DSB signal. Also note that the open-drain port output type option and the high level at reset option must be selected.</p>
<p>3. Buffer input (P80) and buffer output (P81) circuits with built-in zero-cross detection circuits</p>		<p>If this option is selected, the I/O circuit is disabled by the DSB signal. Also note that the open-drain port output type option and the high level at reset option must be selected.</p>

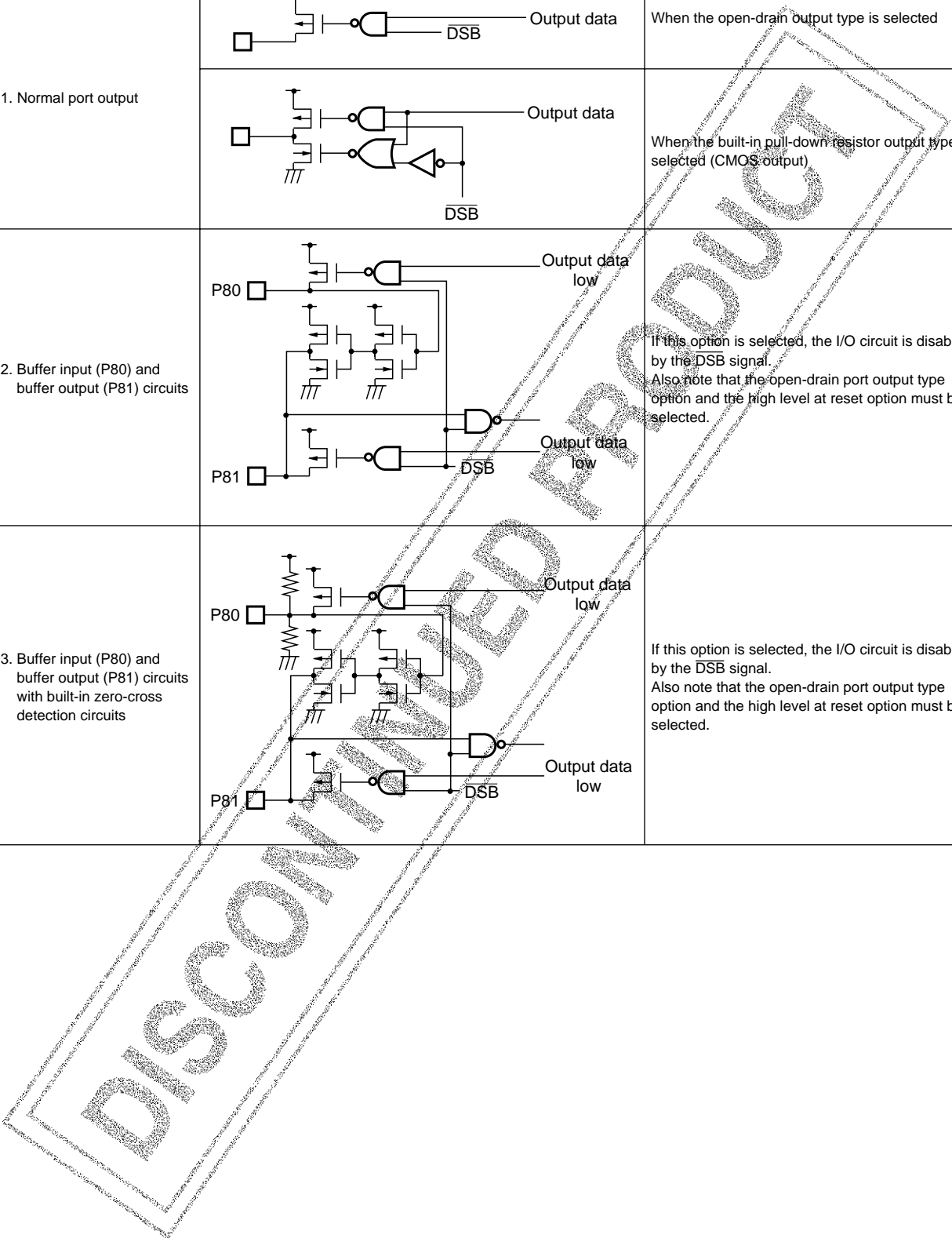

LC665316 Series Option Data Area and Definitions

ROM area	Bit	Option specified	Option/data relationship
3FF0H	7	P5	Output level at reset 0 = high level, 1 = low level
	6	P4	
	5	Sub-oscillator option 0 = port PE, 1 = crystal oscillator	
	4	Oscillator option 0 = external clock, 1 = ceramic oscillator	
	3	P8	Output level at reset 0 = low level, 1 = high level
	2	P1	
	1	P0	
	0	Watchdog timer option 0 = none, 1 = yes (present)	
3FF1H	7	P13	Output type 0 = OD, 1 = PU
	6	P12	
	5	P11	
	4	P10	Output type 0 = OD, 1 = PU
	3	P03	
	2	P02	
	1	P01	
	0	P00	
3FF2H	7	Unused This bit must be set to 0.	
	6	P32	Output type 0 = OD, 1 = PU
	5	P31	
	4	P30	
	3	P23	Output type 0 = OD, 1 = PU
	2	P22	
	1	P21	
0	P20		
3FF3H	7	P53	Output type 0 = OD, 1 = PU
	6	P52	
	5	P51	
	4	P50	Output type 0 = OD, 1 = PU
	3	P43	
	2	P42	
	1	P41	
	0	P40	
3FF4H	7	Unused This bit must be set to 0.	
	6	Unused	
	5	Unused	
	4	Unused	
	3	P63	Output type 0 = OD, 1 = PU
	2	P62	
	1	P61	
0	P60		
3FF5H	7	Unused This bit must be set to 0.	
	6	Unused	
	5	Unused	
	4	Unused	
	3	P83	Output type 0 = OD, 1 = PD
	2	P82	
	1	P81	
0	P80		
3FF6H	7	Unused This bit must be set to 0.	
	6	Unused	
	5	Unused	
	4	Unused	
	3	Unused	
	2	Unused	
	1	Unused	
	0	Unused	

Continued from preceding page.

ROM area	Bit	Option specified	Option/data relationship	
3FF7H	7	Unused	This bit must be set to 0.	
	6			
	5			
	4			
	3	PC3		Output type
	2	PC2		
	1	PC1		
	0	PC0		
		0 = OD, 1 = PU		
3FF8H	7	Unused	This bit must be set to 1.	
	6	Buffer output	0 = used, 1 = none	
	5	Buffer output with zero-cross bias input	0 = used, 1 = none	
	4	PD3	Inverter output	
	3	PD1		
	2	PC3		
	1	P43		
	0	P41		
		0 = inverter output, 1 = none		
3FF9H	7	Unused	This bit must be set to 0.	
	6			
	5			
	4			
	3	Unused		
	2			
	1			
	0			
3FFAH	7	Unused	This bit must be set to 0.	
	6			
	5			
	4			
	3	Unused		
	2			
	1			
	0			
3FFBH	7	Unused	This bit must be set to 0.	
	6			
	5			
	4			
	3	Unused		
	2			
	1			
	0			
3FFCH	7	Unused	This bit must be set to 0.	
	6			
	5			
	4			
	3	Unused		
	2			
	1			
	0			
3FFDH	7	Reserved. Must be set to predefined data values.	This data is generated by the assembler. If the assembler is not used, set this data to '00'.	
	6			
	5			
	4			
	3			
	2			
	1			
	0			

Continued on next page.

Continued from preceding page.

ROM area	Bit	Option specified	Option/data relationship
3FFEh	7	Reserved. Must be set to predefined data values.	This data is generated by the assembler. If the assembler is not used, set this data to '00'.
	6		
	5		
	4		
	3		
	2		
	1		
	0		
3FFFh	7	Reserved. Must be set to predefined data values.	This data is generated by the assembler. If the assembler is not used, set this data to '00'.
	6		
	5		
	4		
	3		
	2		
	1		
	0		

Specifications

Absolute Maximum Ratings at Ta = 25°C, VSS = 0 V

Parameter	Symbol	Conditions	Ratings	Unit	Note
Maximum supply voltage	V _{DD max}	V _{DD}	-0.3 to +7.0	V	
Input voltage	V _{IN1}	P2, P3 (except for the P33/HOLD pin), P61, and P63	-0.3 to +7.0	V	1
	V _{IN2}	All other inputs	-0.3 to V _{DD} + 0.3	V	2
Output voltage	V _{OUT1}	P2, P3 (except for the P33/HOLD pin), P61, and P63	-0.3 to +7.0	V	1
	V _{OUT2}	All other inputs	-0.3 to V _{DD} + 0.3	V	2
Output current per pin	I _{ON1}	P0, P1, P2, P3 (except for the P33/HOLD pin), P4, P5, P6, P8, PC, PD1, PD3	20	mA	3
	-I _{OP1}	P0, P1, P4, P5	2	mA	4
	-I _{OP2}	P2, P3 (except for the P33/HOLD pin), P6, P8, and PC	4	mA	4
	-I _{OP3}	P41, P43, PC3, PD1, PD3, P81	10	mA	4
Total pin current	ΣI _{ON1}	P4, P5, P6, P8, PC	75	mA	3
	ΣI _{ON2}	P0, P1, P2, P3 (except for the P33/HOLD pin), PD1, PD3	75	mA	3
	ΣI _{OP1}	P4, P5, P6, P8, PC	25	mA	4
	ΣI _{OP2}	P0, P1, P2, P3 (except for the P33/HOLD pin), PD1, PD3	25	mA	4
Allowable power dissipation	Pd max	Ta = -30 to +70°C: DIP48S (QFP48E)	600 (430)	mW	5
Operating temperature	T _{opr}		-30 to +70	°C	
Storage temperature	T _{stg}		-55 to +125	°C	

- Note: 1. Applies to pins with open-drain output specifications. For pins with other than open-drain output specifications, the ratings in the pin column for that pin apply.
2. For the oscillator input and output pins, levels up to the free-running oscillation level are allowed.
3. Sink current (Applies to P8 and PD when either the CMOS output specifications or the inverter array specifications have been selected.)
4. Source current (Applies to all pins except P8 and PD for which the pull-up output specifications, the CMOS output specifications, or the inverter array specifications have been selected. Applies to PD pins for which the inverter array specifications have been selected.) Contact your Sanyo representative for the electrical characteristics when the inverter array or buffer array options are specified.
5. We recommend the use of reflow-soldering techniques to solder-mount QFP packages.
Please consult with your Sanyo representative for details on process conditions if the package itself is to be directly immersed in a dip-soldering bath (dip-soldering spray techniques).

Allowable Operating Ranges at Ta = -30 to +70°C, V_{SS} = 0 V, V_{DD} = 3.0 to 5.5 V, unless otherwise specified.

Parameter	Symbol	Conditions	min	typ	max	Unit	Note
Operating supply voltage	V _{DD}	V _{DD}	3.0		5.5	V	
Memory retention supply voltage	V _{DDH}	V _{DD} : During hold mode	1.8		5.5	V	
Input high-level voltage	V _{IH1}	P2, P3 (except for the P33/HOLD pin), P61, and P63: N-channel output transistor off	0.8 V _{DD}		+7.0	V	1
	V _{IH2}	P33/HOLD, P60, P62, RES, OSC1: N-channel output transistor off	0.8 V _{DD}		V _{DD}	V	1
	V _{IH3}	P0, P1, P4, P5, PC, PD, PE: N-channel output transistor off	0.8 V _{DD}		V _{DD}	V	2
Input low-level voltage	V _{IL1}	P2, P3 (except for the P33/HOLD pin), P6, RES, and OSC1: N-channel output transistor off	V _{SS}		0.2 V _{DD}	V	3
	V _{IL2}	P0, P1, P4, P5, PC, PD, PE, TEST: N-channel output transistor off	V _{SS}		0.2 V _{DD}	V	2
	V _{IL3}	P33/HOLD: V _{DD} = 1.8 to 5.5 V	V _{SS}		0.2 V _{DD}	V	
Operating frequency (instruction cycle time)	f _{op} (T _{cyc})	When the main oscillator is operating	0.4 (10)		4.20 (0.95)	MHz (μs)	
		When the sub-oscillator is operating	30 (133)	32.768 (122)	100 (25)	kHz (μs)	
[External clock input conditions]							
Frequency	f _{ext}	OSC1: Defined by Figure 1. Input the clock signal to OSC1 and leave OSC2 open. (External clock input must be selected as the oscillator circuit option.)	0.4		4.20	MHz	
Pulse width	t _{extH} , t _{extL}	OSC1: Defined by Figure 1. Input the clock signal to OSC1 and leave OSC2 open. (External clock input must be selected as the oscillator circuit option.)	100			ns	
Rise and fall times	t _{extR} , t _{extF}	OSC1: Defined by Figure 1. Input the clock signal to OSC1 and leave OSC2 open. (External clock input must be selected as the oscillator circuit option.)			30	ns	

- Note: 1. Applies to pins with open-drain specifications. However, V_{IH2} applies to the P33/HOLD pin. When ports P2, P3, and P6 have CMOS output specifications they cannot be used as input pins.
 2. PC port pins with CMOS output specifications cannot be used as input pins. Contact your Sanyo representative for the allowable operating ranges for P4, PC, and PD when the inverter array is used, and for P8 when the buffer array is used.
 3. Applies to pins with open-drain specifications. However, V_{IL3} applies to the P33/HOLD pin. P2, P3, and P6 port pins with CMOS output specifications cannot be used as input pins.

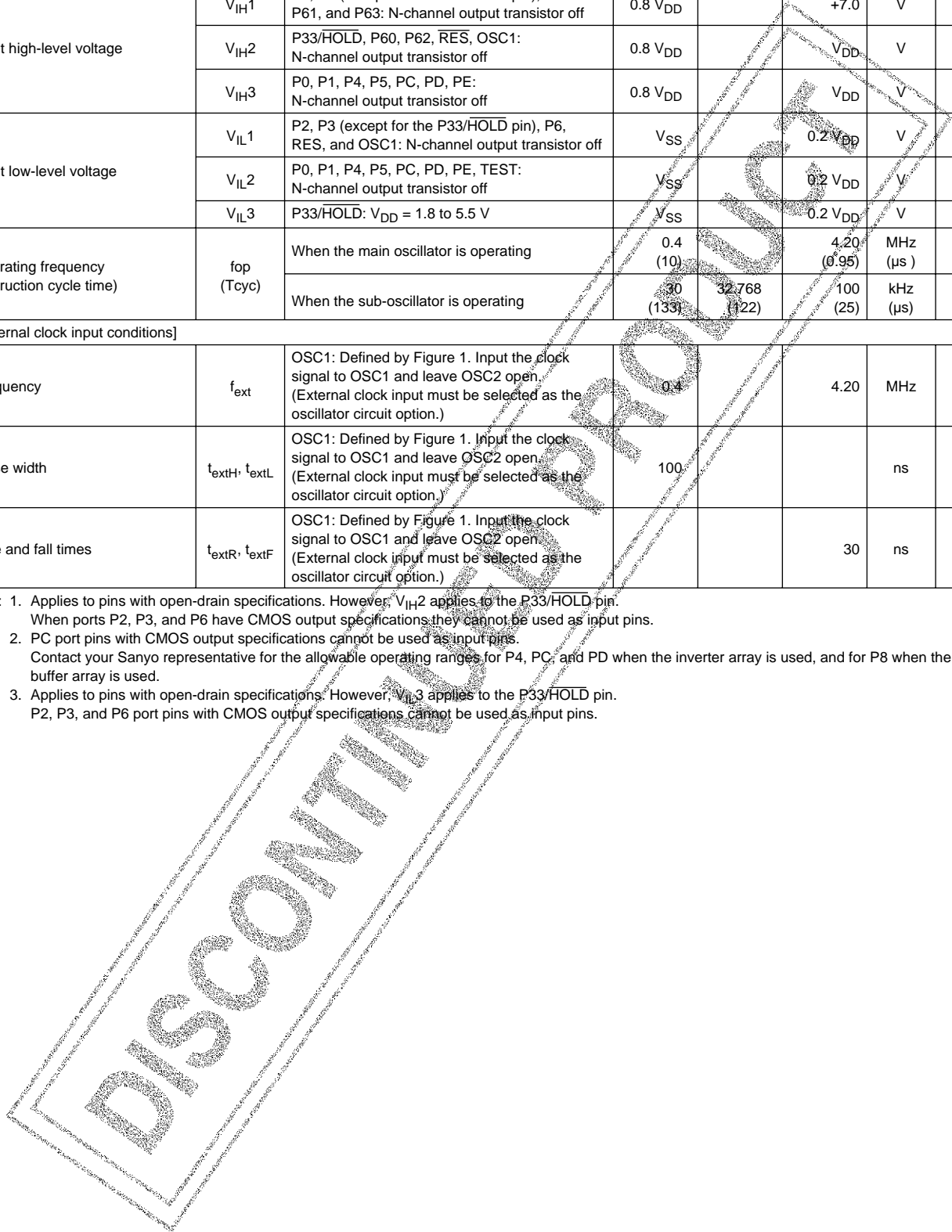

Electrical Characteristics at Ta = -30 to +70°C, VSS = 0 V, VDD = 3.0 to 5.5 V unless otherwise specified.

Parameter	Symbol	Conditions	min	typ	max	Unit	Note
Input high-level current	I _{IH1}	P2, P3 (except for the P33/HOLD pin), P61, and P63: V _{IN} = +7 V, with the output Nch transistor off			5.0	μA	1
	I _{IH2}	P0, P1, P4, P5, P6, PC, OSC1, RES, and P33/HOLD (Does not apply to PD, PE, PC2, PC3, P61, and P63.): V _{IN} = V _{DD} , with the output Nch transistor off			4.0	μA	1
	I _{IH3}	PD, PE, PC2, PC3: V _{IN} = V _{DD} , with the output Nch transistor off			1.0	μA	1
Input low-level current	I _{IL1}	Input ports other than PD, PE, PC2, and PC3: V _{IN} = V _{SS} , with the output Nch transistor off	-1.0			μA	2
	I _{IL2}	PC2, PC3, PD, PE0: V _{IN} = V _{SS} , with the output Nch transistor off	-1.0			μA	2
	I _{IL4}	PE1 (When used as a port; does not apply when the sub-oscillator option is selected.): V _{IN} = V _{SS}		20		μA	1
Output high-level voltage	V _{OH1}	P2, P3 (except for the P33/HOLD pin), P6, P8, and PC: I _{OH} = -1 mA	V _{DD} - 1.0			V	3
		P2, P3 (except for the P33/HOLD pin), P6, P8, and PC: I _{OH} = -0.1 mA	V _{DD} - 0.5				
Value of the output pull-up resistor	R _{PO}	P0, P1, P4, P5	30	100	150	k	4
Output low-level voltage	V _{OL1}	P0, P1, P2, P3, P4, P5, P6, P8, and PC (except for the P33/HOLD pin): I _{OL} = 1.6 mA			0.4	V	5
	V _{OL2}	P0, P1, P2, P3, P4, P5, P6, P8, and PC (except for the P33/HOLD pin): I _{OL} = 8 mA			1.5	V	
Output off leakage current	I _{OFF1}	P2, P3, P61, P63: V _{IN} = +7 V			5.0	μA	6
	I _{OFF2}	Does not apply to P2, P3, P61, P63, and P8. V _{IN} = V _{DD}			1.0	μA	6
	I _{OFF3}	P8: V _{IN} = V _{SS}	-1.0			μA	7
[Schmitt characteristics]							
Hysteresis voltage	V _{HYS}			0.1 V _{DD}		V	
High-level threshold voltage	V _{tH}	P2, P3, P5, P6, OSC1 (EXT), RES	0.5 V _{DD}		0.8 V _{DD}	V	
Low-level threshold voltage	V _{tL}		0.2 V _{DD}		0.5 V _{DD}	V	
[Ceramic oscillator]							
Oscillator frequency	f _{CF}	OSC1, OSC2: Figure 2, 4 MHz		4.0		MHz	
Oscillator stabilization time	f _{CFS}	Figure 3, 4 MHz			10.0	ms	
[Crystal oscillator]							
Oscillator frequency	f _{XT}	XT1, XT2: Figure 2, when the sub-oscillator option is selected, 32 kHz		32.768		kHz	
Oscillator stabilization time	f _{XTS}	Figure 3, when the sub-oscillator option is selected, 32 kHz		1.0	5.0	s	
[Serial clock]							
Cycle time	Input	t _{CKCY}	0.9			μs	
	Output		2.0			T _{cyc}	
Low-level and high-level pulse widths	Input	t _{CKL}	0.4			μs	
	Output		1.0			T _{cyc}	
Rise and fall times	Output	t _{CKR} , t _{CKF}			0.1	μs	
[Serial input]							
Data setup time	t _{ICK}	S10, S11: With the timing of Figure 4. Stipulated with respect to the rising edge (↑) of SCK0 or SCK1.	0.3			μs	
Data hold time	t _{ICKI}		0.3			μs	
[Serial output]							
Output delay time	t _{CKO}	S00, S01: With the timing of Figure 5 and the test load of Figure 5. Stipulated with respect to the falling edge (↓) of SCK0 or SCK1.			0.3	μs	

Continued on next page.

Continued from preceding page.

Parameter	Symbol	Conditions	min	typ	max	Unit	Note
[Pulse conditions]							
INT0 high and low-level	t_{IOH}, t_{IOL}	INT0: Figure 6, conditions under which the INTO interrupt can be accepted, conditions under which the timer 0 event counter or pulse width measurement input can be accepted	2			Tcyc	
High and low-level pulse widths for interrupt inputs other than INTO	t_{IIH}, t_{IIL}	INT1: Figure 6, conditions under which the corresponding interrupt can be accepted	2			Tcyc	
PIN1 high and low-level pulse widths	t_{PINH}, t_{PINL}	PIN1: Figure 6, conditions under which the timer 1 event counter input can be accepted	2			Tcyc	
RES high and low-level pulse widths	t_{RSH}, t_{RSL}	RES: Figure 6, conditions under which reset can be applied.	3			Tcyc	
Operating current drain	I_{DDOP}	V_{DD} : 4-MHz ceramic oscillator		4.0	8.0	mA	8
		V_{DD} : 4-MHz ceramic oscillator, $V_{DD} = 3.0$ to 4.0 V		3.0	5.0	mA	
		V_{DD} : 4-MHz external clock		4.0	8.0	mA	
Halt mode current drain	I_{DDHALT}	V_{DD} : 4-MHz ceramic oscillator		2.0	3.5	mA	
		V_{DD} : 4-MHz ceramic oscillator, $V_{DD} = 3.0$ to 4.0 V		1.0	2.0	mA	
		V_{DD} : 4-MHz external clock		2.0	3.5	mA	
		V_{DD} : 32 kHz (main oscillator stopped), sub-oscillator: crystal		10	100	μ A	
		V_{DD} : 32 kHz (main oscillator stopped), sub-oscillator: crystal, $V_{DD} = 3.0$ to 4.0 V		10	50	μ A	
Hold mode current drain	I_{DDHOLD}	$V_{DD}: V_{DD} = 1.8$ to 5.5 V		0.01	10	μ A	

- Note: 1. With the output Nch transistor off in shared I/O ports with the open-drain output specifications. These pins cannot be used as input pins if the CMOS output specifications are selected. When the port option is selected for PE.
2. With the output Nch transistor off in shared I/O ports with the open-drain output specifications. The rating for the pull-up output specification pins is stipulated in terms of the output pull-up current IPO. These pins cannot be used as input pins if the CMOS output specifications are selected.
3. With the output Nch transistor off for CMOS output specification pins. (Also applies when the Pch open-drain option is selected for P8.)
4. With the output Nch transistor off for pull-up output specification pins.
5. When CMOS output specifications are selected for P8.
6. With the output Nch transistor off for open-drain output specification pins.
7. With the output Pch transistor off for open-drain output specification pins.
8. Reset state

Comparator Characteristics at $T_a = -30$ to $+70$ °C, $V_{SS} = 0$ V

Parameter	Symbol	Conditions	min	typ	max	Unit	Note
Absolute precision	V_{CECM}	AN1 to AN4: $V_{DD} = 3.0$ to 5.5 V		$\pm 1/2$	± 1	LSB	1
Threshold voltage	V_{THCM}	$V_{DD} = 3.0$ to 5.5 V	V_{SS}		V_{DD}	V	
Input voltage	V_{INCM}	AN1 to AN4: $V_{DD} = 3.0$ to 5.5 V	V_{SS}		V_{DD}	V	
Conversion time	T_{CCM}	$V_{DD} = 3.0$ to 5.5 V			20	ms	
		$V_{DD} = 4.0$ to 5.5 V			30	μ s	

Note: 1. Does not include the quantization error.

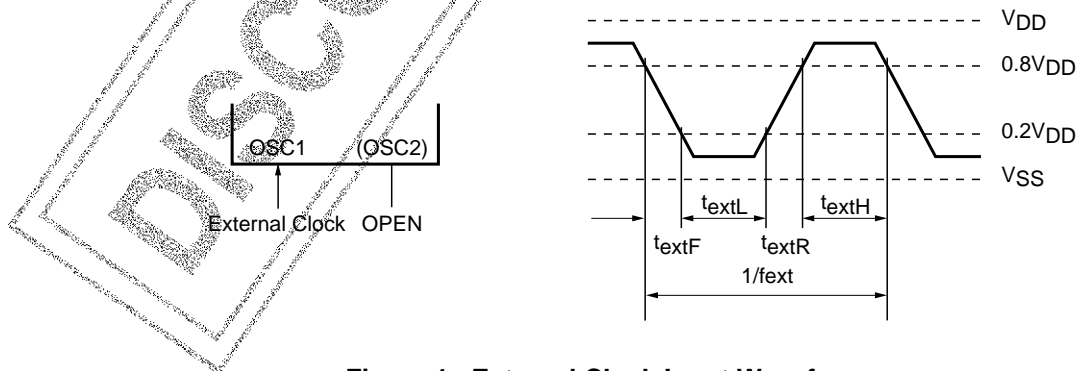

Figure 1 External Clock Input Waveform

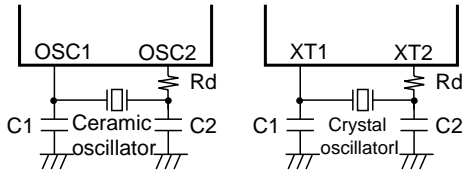

Figure 2 Ceramic Oscillator Circuit

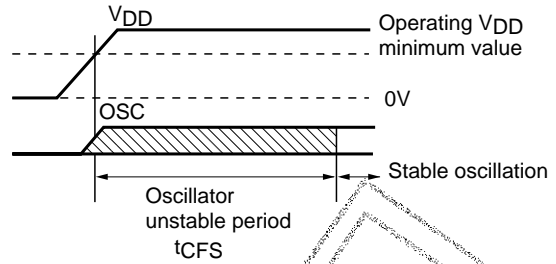

Figure 3 Oscillator Stabilization Period

Table 1 Guaranteed Ceramic Oscillator Constants External capacitor type

External capacitor type		Built-in capacitor type	
4 MHz (Murata Mfg. Co., Ltd.) CSA4.00MG	C1 = 33 pF ± 10%	4 MHz (Murata Mfg Co., Ltd) CST4.00MG	Rd = 220 ± 5%
	C2 = 33 pF ± 10%		
	Rd = 220 ± 5%		
4 MHz (Kyocera Corporation) KBR4.0MS	C1 = 33 pF ± 10%	4 MHz (Kyocera Corporation) KBR4.0MES	
	C2 = 33 pF ± 10%		
	Rd = 0		

Table 2 Guaranteed Crystal Oscillator Constants

32 kHz (Seiko Epson) C-002RX	C1 = 18 pF ± 10%
	C2 = 18 pF ± 10%
	Rd = 470 k ± 5%

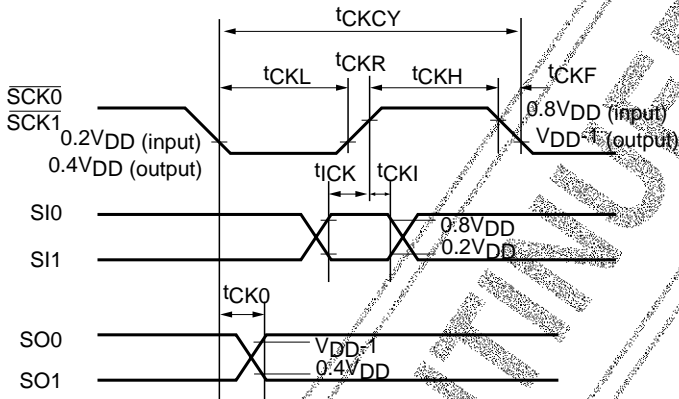

Figure 4 Serial I/O Timing

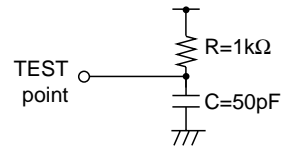

Figure 5 Timing Load

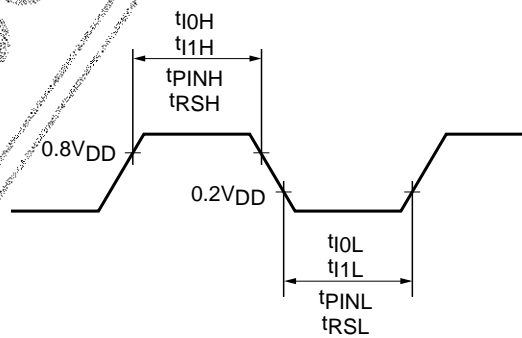

Figure 6 Input Timing for the INT0, INT1, INT2, PIN1, and RES pins

LC66XXXX Series Instruction Table (by function)

Abbreviations:

- AC: Accumulator
- E: E register
- CF: Carry flag
- ZF: Zero flag
- HL: Data pointer DPH, DPL
- XY: Data pointer DPX, DPY
- M: Data memory
- M (HL): Data memory pointed to by the DPH, DPL data pointer
- M (XY): Data memory pointed to by the DPX, DPY auxiliary data pointer
- M2 (HL): Two words of data memory (starting on an even address) pointed to by the DPH, DPL data pointer
- SP: Stack pointer
- M2 (SP): Two words of data memory pointed to by the stack pointer
- M4 (SP): Four words of data memory pointed to by the stack pointer
- in: n bits of immediate data
- t2: Bit specification

t2	11	10	01	00
Bit	2 ³	2 ²	2 ¹	2 ⁰

- PCh: Bits 8 to 11 in the PC
- PCm: Bits 4 to 7 in the PC
- PCl: Bits 0 to 3 in the PC
- Fn: User flag, n = 0 to 15
- TIMER0: Timer 0
- TIMER1: Timer 1
- SIO: Serial register
- P: Port
- P (i4): Port indicated by 4 bits of immediate data
- INT: Interrupt enable flag
- (), []: Indicates the contents of a location
- ←: Transfer direction, result
- ⊕: Exclusive or
- ∧: Logical and
- ∨: Logical or
- +: Addition
- : Subtraction
- : Taking the one's complement

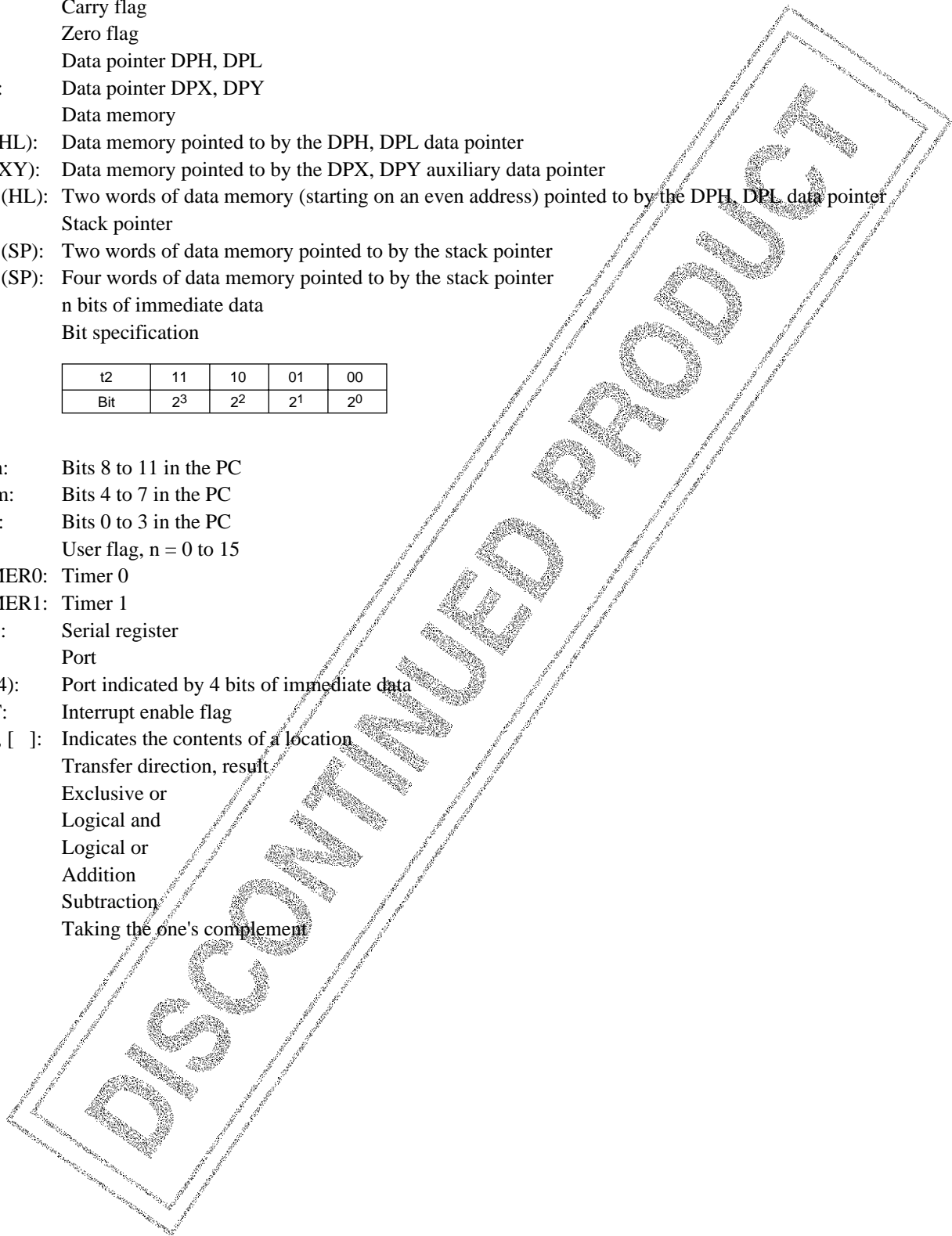

LC665304A, 665306A, 665308A, 665312A, 665316A

Mnemonic		Instruction code		Number of bytes	Number of cycles	Operation	Description	Affected status bits	Note
		D ₇ D ₆ D ₅ D ₄	D ₃ D ₂ D ₁ D ₀						
[Accumulator manipulation instructions]									
CLA	Clear AC	1 0 0 0	0 0 0 0	1	1	$AC \leftarrow 0$ (Equivalent to LAI 0.)	Clear AC to 0.	ZF	Has a vertical skip function.
DAA	Decimal adjust AC in addition	1 1 0 0 0 0 1 0	1 1 1 1 0 1 1 0	2	2	$AC \leftarrow (AC) + 6$ (Equivalent to ADI 6.)	Add six to AC.	ZF	
DAS	Decimal adjust AC in subtraction	1 1 0 0 0 0 1 0	1 1 1 1 1 0 1 0	2	2	$AC \leftarrow (AC) + 10$ (Equivalent to ADI 0AH.)	Add 10 to AC.	ZF	
CLC	Clear CF	0 0 0 1	1 1 1 0	1	1	$CF \leftarrow 0$	Clear CF to 0.	CF	
STC	Set CF	0 0 0 1	1 1 1 1	1	1	$CF \leftarrow 1$	Set CF to 1.	CF	
CMA	Complement AC	0 0 0 1	1 0 0 0	1	1	$AC \leftarrow \overline{(AC)}$	Take the one's complement of AC.	ZF	
IA	Increment AC	0 0 0 1	0 1 0 0	1	1	$AC \leftarrow (AC) + 1$	Increment AC.	ZF, CF	
DA	Decrement AC	0 0 1 0	0 1 0 0	1	1	$AC \leftarrow (AC) - 1$	Decrement AC.	ZF, CF	
RAR	Rotate AC right through CF	0 0 0 1	0 0 0 0	1	1	$AC_3 \leftarrow (CF)$, $AC_n \leftarrow (AC)_{n+1}$, $CF \leftarrow (AC)_0$	Shift AC (including CF) right.	CF	
RAL	Rotate AC left through CF	0 0 0 0	0 0 0 1	1	1	$AC_0 \leftarrow (CF)$, $AC_{n+1} \leftarrow (AC)_n$, $CF \leftarrow (AC)_3$	Shift AC (including CF) left.	CF, ZF	
TAE	Transfer AC to E	0 1 0 0	0 1 0 1	1	1	$E \leftarrow (AC)$	Transfer the contents of AC to E.		
TEA	Transfer E to AC	0 1 0 0	0 1 1 0	1	1	$AC \leftarrow (E)$	Transfer the contents of E to AC.	ZF	
XAE	Exchange AC with E	0 1 0 0	0 1 0 0	1	1	$(AC) \leftrightarrow (E)$	Exchange the contents of AC and E.		
[Memory manipulation instructions]									
IM	Increment M	0 0 0 1	0 0 1 0	1	1	$M(HL) \leftarrow [M(HL)] + 1$	Increment M (HL).	ZF, CF	
DM	Decrement M	0 0 1 0	0 0 1 0	1	1	$M(HL) \leftarrow [M(HL)] - 1$	Decrement M (HL).	ZF, CF	
IMDR i8	Increment M direct	1 1 0 0 I ₇ I ₆ I ₅ I ₄	0 1 1 1 I ₃ I ₂ I ₁ I ₀	2	2	$M(i8) \leftarrow [M(i8)] + 1$	Increment M (i8).	ZF, CF	
DMDR i8	Decrement M direct	1 1 0 0 I ₇ I ₆ I ₅ I ₄	0 0 1 1 I ₃ I ₂ I ₁ I ₀	2	2	$M(i8) \leftarrow [M(i8)] - 1$	Decrement M (i8).	ZF, CF	
SMB t2	Set M data bit	0 0 0 0	1 1 t ₁ t ₀	1	1	$[M(HL), t2] \leftarrow 1$	Set the bit in M (HL) specified by t ₀ and t ₁ to 1.		
RMB t2	Reset M data bit	0 0 1 0	1 1 t ₁ t ₀	1	1	$[M(HL), t2] \leftarrow 0$	Clear the bit in M (HL) specified by t ₀ and t ₁ to 0.	ZF	
[Arithmetic, logic and comparison instructions]									
AD	Add M to AC	0 0 0 0	0 1 1 0	1	1	$AC \leftarrow (AC) + [M(HL)]$	Add the contents of AC and M (HL) as two's complement values and store the result in AC.	ZF, CF	
ADDR i8	Add M direct to AC	1 1 0 0 I ₇ I ₆ I ₅ I ₄	1 0 0 1 I ₃ I ₂ I ₁ I ₀	2	2	$AC \leftarrow (AC) + [M(i8)]$	Add the contents of AC and M (i8) as two's complement values and store the result in AC.	ZF, CF	
ADC	Add M to AC with CF	0 0 0 0	0 0 1 0	1	1	$AC \leftarrow (AC) + [M(HL)] + (CF)$	Add the contents of AC, M (HL) and C as two's complement values and store the result in AC.	ZF, CF	
ADI i4	Add immediate data to AC	1 1 0 0 0 0 1 0	1 1 1 1 I ₃ I ₂ I ₁ I ₀	2	2	$AC \leftarrow (AC) + I_3, I_2, I_1, I_0$	Add the contents of AC and the immediate data as two's complement values and store the result in AC.	ZF	
SUBC	Subtract AC from M with CF	0 0 0 1	0 1 1 1	1	1	$AC \leftarrow [M(HL)] - (AC) - (CF)$	Subtract the contents of AC and CF from M (HL) as two's complement values and store the result in AC.	ZF, CF	CF will be zero if there was a borrow and one otherwise.
ANDA	And M with AC then store AC	0 0 0 0	0 1 1 1	1	1	$AC \leftarrow (AC) \wedge [M(HL)]$	Take the logical and of AC and M (HL) and store the result in AC.	ZF	
ORA	Or M with AC then store AC	0 0 0 0	0 1 0 1	1	1	$AC \leftarrow (AC) \vee [M(HL)]$	Take the logical or of AC and M (HL) and store the result in AC.	ZF	

Continued on next page.

Continued from preceding page.

Mnemonic	Instruction code	D ₇ D ₆ D ₅ D ₄	D ₃ D ₂ D ₁ D ₀	Number of bytes	Number of cycles	Operation	Description	Affected status bits	Note												
[Arithmetic, logic and comparison instructions]																					
EXL	Exclusive or M with AC then store AC	0 0 0 1	0 1 0 1	1	1	$AC \leftarrow (AC) \oplus [M(HL)]$	Take the logical exclusive or of AC and M (HL) and store the result in AC.	ZF													
ANDM	And M with AC then store M	0 0 0 0	0 0 1 1	1	1	$M(HL) \leftarrow (AC) \wedge [M(HL)]$	Take the logical and of AC and M (HL) and store the result in M (HL).	ZF													
ORM	Or M with AC then store M	0 0 0 0	0 1 0 0	1	1	$M(HL) \leftarrow (AC) \vee [M(HL)]$	Take the logical or of AC and M (HL) and store the result in M (HL).	ZF													
CM	Compare AC with M	0 0 0 1	0 1 1 0	1	1	$[M(HL)] + (AC) + 1$	Compare the contents of AC and M (HL) and set or clear CF and ZF according to the result. <table border="1"> <tr> <td>Magnitude comparison</td> <td>CF</td> <td>ZF</td> </tr> <tr> <td>$[M(HL)] > (AC)$</td> <td>0</td> <td>0</td> </tr> <tr> <td>$[M(HL)] = (AC)$</td> <td>1</td> <td>1</td> </tr> <tr> <td>$[M(HL)] < (AC)$</td> <td>1</td> <td>0</td> </tr> </table>	Magnitude comparison	CF	ZF	$[M(HL)] > (AC)$	0	0	$[M(HL)] = (AC)$	1	1	$[M(HL)] < (AC)$	1	0	ZF, CF	
Magnitude comparison	CF	ZF																			
$[M(HL)] > (AC)$	0	0																			
$[M(HL)] = (AC)$	1	1																			
$[M(HL)] < (AC)$	1	0																			
CI i4	Compare AC with immediate data	1 1 0 0 1 0 1 0	1 1 1 1 i ₃ i ₂ i ₁ i ₀	2	2	$i_3 i_2 i_1 i_0 + (AC) + 1$	Compare the contents of AC and the immediate data i ₃ i ₂ i ₁ i ₀ and set or clear CF and ZF according to the result. <table border="1"> <tr> <td>Magnitude comparison</td> <td>CF</td> <td>ZF</td> </tr> <tr> <td>$i_3 i_2 i_1 i_0 > AC$</td> <td>0</td> <td>0</td> </tr> <tr> <td>$i_3 i_2 i_1 i_0 = AC$</td> <td>1</td> <td>1</td> </tr> <tr> <td>$i_3 i_2 i_1 i_0 < AC$</td> <td>1</td> <td>0</td> </tr> </table>	Magnitude comparison	CF	ZF	$i_3 i_2 i_1 i_0 > AC$	0	0	$i_3 i_2 i_1 i_0 = AC$	1	1	$i_3 i_2 i_1 i_0 < AC$	1	0	ZF, CF	
Magnitude comparison	CF	ZF																			
$i_3 i_2 i_1 i_0 > AC$	0	0																			
$i_3 i_2 i_1 i_0 = AC$	1	1																			
$i_3 i_2 i_1 i_0 < AC$	1	0																			
CLI i4	Compare DP _L with immediate data	1 1 0 0 1 0 1 1	1 1 1 1 i ₃ i ₂ i ₁ i ₀	2	2	ZF ← 1 if (DP _L) > i ₃ i ₂ i ₁ i ₀ ZF ← 0 if (DP _L) = i ₃ i ₂ i ₁ i ₀	Compare the contents of DP _L with the immediate data. Set ZF if identical and clear ZF if not.	ZF													
CMB t2	Compare AC bit with M data bit	1 1 0 0 1 1 0 1	1 1 1 1 0 0 t ₁ t ₀	2	2	ZF ← 1 if (AC, t ₂) = [M(HL), t ₂] ZF ← 0 if (AC, t ₂) ≠ [M(HL), t ₂]	Compare the corresponding bits specified by t ₀ and t ₁ in AC and M (HL). Set ZF if identical and clear ZF if not.	ZF													
[Load and store instructions]																					
LAE	Load AC and E from M2 (HL)	0 1 0 1	1 1 0 0	1	1	$AC \leftarrow M(HL), E \leftarrow M(HL + 1)$	Load the contents of M2 (HL) into AC, E.														
LAI i4	Load AC with immediate data	1 0 0 0	i ₃ i ₂ i ₁ i ₀	1	1	$AC \leftarrow i_3 i_2 i_1 i_0$	Load the immediate data into AC.	ZF	Has a vertical skip function												
LADR i8	Load AC from M direct	1 1 0 0	0 0 0 1 i ₇ i ₆ i ₅ i ₄ i ₃ i ₂ i ₁ i ₀	2	2	$AC \leftarrow [M(i8)]$	Load the contents of M (i8) into AC.	ZF													
S	Store AC to M	0 1 0 0	0 1 1 1	1	1	$M(HL) \leftarrow (AC)$	Store the contents of AC into M (HL).														
SAE	Store AC and E to M2 (HL)	0 1 0 1	1 1 1 0	1	1	$M(HL) \leftarrow (AC), M(HL + 1) \leftarrow (E)$	Store the contents of AC, E into M2 (HL).														
LA reg	Load AC from M (reg)	0 1 0 0	1 0 t ₀ 0	1	1	$AC \leftarrow [M(\text{reg})]$	Load the contents of M (reg) into AC. The reg is either HL or XY depending on t ₀ . <table border="1"> <tr> <td>reg</td> <td>T₀</td> </tr> <tr> <td>HL</td> <td>0</td> </tr> <tr> <td>XY</td> <td>1</td> </tr> </table>	reg	T ₀	HL	0	XY	1	ZF							
reg	T ₀																				
HL	0																				
XY	1																				

Continued on next page.

LC665304A, 665306A, 665308A, 665312A, 665316A

Continued from preceding page.

Mnemonic		Instruction code		Number of bytes	Number of cycles	Operation	Description	Affected status bits	Note						
		D ₇ D ₆ D ₅ D ₄	D ₃ D ₂ D ₁ D ₀												
[Load and store instructions]															
LA reg, I	Load AC from M (reg) then increment reg	0 1 0 0	1 0 t ₀ 1	1	2	AC ← [M (reg)] DP _L ← (DP _L) + 1 or DP _Y ← (DP _Y) + 1	Load the contents of M (reg) into AC. (The reg is either HL or XY.) Then increment the contents of either DP _L or DP _Y . The relationship between t ₀ and reg is the same as that for the LA reg instruction.	ZF	ZF is set according to the result of incrementing DP _L or DP _Y .						
LA reg, D	Load AC from M (reg) then decrement reg	0 1 0 1	1 0 t ₀ 1	1	2	AC ← [M (reg)] DP _L ← (DP _L) - 1 or DP _Y ← (DP _Y) - 1	Load the contents of M (reg) into AC. (The reg is either HL or XY.) Then decrement the contents of either DP _L or DP _Y . The relationship between t ₀ and reg is the same as that for the LA reg instruction.	ZF	ZF is set according to the result of decrementing DP _L or DP _Y .						
XA reg	Exchange AC with M (reg)	0 1 0 0	1 1 t ₀ 0	1	1	(AC) ↔ [M (reg)]	Exchange the contents of M (reg) and AC. The reg is either HL or XY depending on t ₀ .								
							<table border="1"> <thead> <tr> <th>reg</th> <th>t₀</th> </tr> </thead> <tbody> <tr> <td>HL</td> <td>0</td> </tr> <tr> <td>XY</td> <td>1</td> </tr> </tbody> </table>	reg	t ₀	HL	0	XY	1		
reg	t ₀														
HL	0														
XY	1														
XA reg, I	Exchange AC with M (reg) then increment reg	0 1 0 0	1 1 t ₀ 1	1	2	(AC) ↔ [M (reg)] DP _L ← (DP _L) + 1 or DP _Y ← (DP _Y) + 1	Exchange the contents of M (reg) and AC. (The reg is either HL or XY.) Then increment the contents of either DP _L or DP _Y . The relationship between t ₀ and reg is the same as that for the XA reg instruction.	ZF	ZF is set according to the result of incrementing DP _L or DP _Y .						
XA reg, D	Exchange AC with M (reg) then decrement reg	0 1 0 1	1 1 t ₀ 1	1	2	(AC) ↔ [M (reg)] DP _L ← (DP _L) - 1 or DP _Y ← (DP _Y) - 1	Exchange the contents of M (reg) and AC. (The reg is either HL or XY.) Then decrement the contents of either DP _L or DP _Y . The relationship between t ₀ and reg is the same as that for the XA reg instruction.	ZF	ZF is set according to the result of decrementing DP _L or DP _Y .						
XADR i8	Exchange AC with M direct	1 1 0 0	1 0 0 0	2	2	(AC) ↔ [M (i8)]	Exchange the contents of AC and M (i8).								
LEAI i8	Load E & AC with immediate data	1 1 0 0	0 1 1 0	2	2	E ← i ₇ i ₆ i ₅ i ₄ AC ← i ₃ i ₂ i ₁ i ₀	Load the immediate data i8 into E, AC.								
RTBL	Read table data from program ROM	0 1 0 1	1 0 1 0	1	2	E, AC ← [ROM (PCh, E, AC)]	Load into E, AC the ROM data at the location determined by replacing the lower 8 bits of the PC with E, AC.								
RTBLP	Read table data from program ROM then output to P4, 5	0 1 0 1	1 0 0 0	1	2	Port 4, 5 ← [ROM (PCh, E, AC)]	Output from ports 4 and 5 the ROM data at the location determined by replacing the lower 8 bits of the PC with E, AC.								
[Data pointer manipulation instructions]															
LDZ i4	Load DP _H with zero and DP _L with immediate data respectively	0 1 1 0	i ₃ i ₂ i ₁ i ₀	1	1	DP _H ← 0 DP _L ← i ₃ i ₂ i ₁ i ₀	Load zero into DP _H and the immediate data i4 into DP _L .								
LHI i4	Load DP _H with immediate data	1 1 0 0	1 1 1 1	2	2	DP _H ← i ₃ i ₂ i ₁ i ₀	Load the immediate data i4 into DP _H .								
LLI i4	Load DP _L with immediate data	1 1 0 0	1 1 1 1	2	2	DP _L ← i ₃ i ₂ i ₁ i ₀	Load the immediate data i4 into DP _L .								
LHLI i8	Load DP _H , DP _L with immediate data	1 1 0 0	0 0 0 0	2	2	DP _H ← i ₇ i ₆ i ₅ i ₄ DP _L ← i ₃ i ₂ i ₁ i ₀	Load the immediate data into DP _H , DP _L .								
LXYI i8	Load DP _X , DP _Y with immediate data	1 1 0 0	0 0 0 0	2	2	DP _X ← i ₇ i ₆ i ₅ i ₄ DP _Y ← i ₃ i ₂ i ₁ i ₀	Load the immediate data into DP _X , DP _Y .								

Continued on next page.

Continued from preceding page.

Mnemonic	Instruction code	D ₇ D ₆ D ₅ D ₄	D ₃ D ₂ D ₁ D ₀	Number of bytes	Number of cycles	Operation	Description	Affected status bits	Note
[Data pointer manipulation instructions]									
IL	Increment DP _L	0 0 0 1	0 0 0 1	1	1	DP _L ← (DP _L) + 1	Increment the contents of DP _L .	ZF	
DL	Decrement DP _L	0 0 1 0	0 0 0 1	1	1	DP _L ← (DP _L) - 1	Decrement the contents of DP _L .	ZF	
IY	Increment DP _Y	0 0 0 1	0 0 1 1	1	1	DP _Y ← (DP _Y) + 1	Increment the contents of DP _Y .	ZF	
DY	Decrement DP _Y	0 0 1 0	0 0 1 1	1	1	DP _Y ← (DP _Y) - 1	Decrement the contents of DP _Y .	ZF	
TAH	Transfer AC to DP _H	1 1 0 0 1 1 1 1	1 1 1 1 0 0 0 0	2	2	DP _H ← (AC)	Transfer the contents of AC to DP _H .		
THA	Transfer DP _H to AC	1 1 0 0 1 1 1 0	1 1 1 1 0 0 0 0	2	2	AC ← (DP _H)	Transfer the contents of DP _H to AC.	ZF	
XAH	Exchange AC with DP _H	0 1 0 0	0 0 0 0	1	1	(AC) ↔ (DP _H)	Exchange the contents of AC and DP _H .		
TAL	Transfer AC to DP _L	1 1 0 0 1 1 1 1	1 1 1 1 0 0 0 1	2	2	DP _L ← (AC)	Transfer the contents of AC to DP _L .		
TLA	Transfer DP _L to AC	1 1 0 0 1 1 1 0	1 1 1 1 0 0 0 1	2	2	AC ← (DP _L)	Transfer the contents of DP _L to AC.	ZF	
XAL	Exchange AC with DP _L	0 1 0 0	0 0 0 1	1	1	(AC) ↔ (DP _L)	Exchange the contents of AC and DP _L .		
TAX	Transfer AC to DP _X	1 1 0 0 1 1 1 1	1 1 1 1 0 0 1 0	2	2	DP _X ← (AC)	Transfer the contents of AC to DP _X .		
TXA	Transfer DP _X to AC	1 1 0 0 1 1 1 0	1 1 1 1 0 0 1 0	2	2	AC ← (DP _X)	Transfer the contents of DP _X to AC.	ZF	
XAX	Exchange AC with DP _X	0 1 0 0	0 0 1 0	1	1	(AC) ↔ (DP _X)	Exchange the contents of AC and DP _X .		
TAY	Transfer AC to DP _Y	1 1 0 0 1 1 1 1	1 1 1 1 0 0 1 1	2	2	DP _Y ← (AC)	Transfer the contents of AC to DP _Y .		
TYA	Transfer DP _Y to AC	1 1 0 0 1 1 1 0	1 1 1 1 0 0 1 1	2	2	AC ← (DP _Y)	Transfer the contents of DP _Y to AC.	ZF	
XAY	Exchange AC with DP _Y	0 1 0 0	0 0 1 1	1	1	(AC) ↔ (DP _Y)	Exchange the contents of AC and DP _Y .		
[Flag manipulation instructions]									
SFB n4	Set flag bit	0 1 1 1	n ₃ n ₂ n ₁ n ₀	1	1	F _n ← 1	Set the flag specified by n4 to 1.		
RFB n4	Reset flag bit	0 0 1 1	n ₃ n ₂ n ₁ n ₀	1	1	F _n ← 0	Reset the flag specified by n4 to 0.	ZF	
[Jump and subroutine instructions]									
JMP addr	Jump in the current bank	1 1 1 0 P ₇ P ₆ P ₅ P ₄	P ₁₁ P ₁₀ P ₉ P ₈ P ₃ P ₂ P ₁ P ₀	2	2	PC13, 12 ← PC13, 12 PC13, 12 PC11 to 0 ← P ₁₁ to P ₈	Jump to the location in the same bank specified by the immediate data P12.		This becomes PC12 + (PC12) immediately following a BANK instruction.
JPEA	Jump to the address stored at E and AC in the current page	0 0 1 0	0 1 1 1	1	1	PC13 to 8 ← PC13 to 8, PC7 to 4 ← (E), PC3 to 0 ← (AC)	Jump to the location determined by replacing the lower 8 bits of the PC by E, AC.		
CAL addr	Call subroutine	0 1 0 1 P ₇ P ₆ P ₅ P ₄	0 P ₁₀ P ₉ P ₈ P ₃ P ₂ P ₁ P ₀	2	2	PC13 to 11 ← 0, PC10 to 0 ← P ₁₀ to P ₀ , M4 (SP) ← (CF, ZF, PC13 to 0), SP ← (SP)-4	Call a subroutine.		
CZP addr	Call subroutine in the zero page	1 0 1 0	P ₃ P ₂ P ₁ P ₀	1	2	PC13 to 6, PC10 ← 0, PC5 to 2 ← P ₃ to P ₀ , M4 (SP) ← (CF, ZF, PC12 to 0), SP ← SP-4	Call a subroutine on page 0 in bank 0.		
BANK	Change bank	0 0 0 1	1 0 1 1	1	1		Change the memory bank and register bank.		

Continued on next page.

Continued from preceding page.

Mnemonic	Instruction code		Number of bytes	Number of cycles	Operation	Description	Affected status bits	Note																
	D ₇ D ₆ D ₅ D ₄	D ₃ D ₂ D ₁ D ₀																						
[Jump and subroutine instructions]																								
PUSH reg	Push reg on M2 (SP)	1 1 0 0 1 1 1 1	1 1 1 1 1 i ₁ i ₀ 0	2	2	M2 (SP) ← (reg) SP ← (SP) - 2	Store the contents of reg in M2 (SP). Subtract 2 from SP after the store. <table border="1" style="margin-left: 20px;"> <tr><td>reg</td><td>i₁</td><td>i₀</td></tr> <tr><td>HL</td><td>0</td><td>0</td></tr> <tr><td>XY</td><td>0</td><td>1</td></tr> <tr><td>AE</td><td>1</td><td>0</td></tr> <tr><td>Illegal value</td><td>1</td><td>1</td></tr> </table>	reg	i ₁	i ₀	HL	0	0	XY	0	1	AE	1	0	Illegal value	1	1		
reg	i ₁	i ₀																						
HL	0	0																						
XY	0	1																						
AE	1	0																						
Illegal value	1	1																						
POP reg	Pop reg off M2 (SP)	1 1 0 0 1 1 1 0	1 1 1 1 1 i ₁ i ₀ 0	2	2	SP ← (SP) + 2 reg ← [M2 (SP)]	Add 2 to SP and then load the contents of M2(SP) into reg. The relation between i1i0 and reg is the same as that for the PUSH reg instruction.																	
RT	Return from subroutine	0 0 0 1	1 1 0 0 0	1	2	SP ← (SP) + 4 PC ← [M4 (SP)]	Return from a subroutine or interrupt handling routine. ZF and CF are not restored.																	
RTI	Return from interrupt routine	0 0 0 1	1 1 0 1	1	2	SP ← (SP) + 4 PC ← [M4 (SP)] CF, ZF ← [M4 (SP)]	Return from a subroutine or interrupt handling routine. ZF and CF are restored.	ZF, CF																
[Branch instructions]																								
BAt2 addr	Branch on AC bit	1 1 0 1 P ₇ P ₆ P ₅ P ₄	0 0 t ₁ t ₀ P ₃ P ₂ P ₁ P ₀	2	2	PC7 to 0 ← P ₇ P ₆ P ₅ P ₄ P ₃ P ₂ P ₁ P ₀ if (AC, t ₂) = 1	Branch to the location in the same page specified by P ₇ to P ₀ if the bit in AC specified by the immediate data t ₁ t ₀ is one.																	
BNAt2 addr	Branch on no AC bit	1 0 0 1 P ₇ P ₆ P ₅ P ₄	0 0 t ₁ t ₀ P ₃ P ₂ P ₁ P ₀	2	2	PC7 to 0 ← P ₇ P ₆ P ₅ P ₄ P ₃ P ₂ P ₁ P ₀ if (AC, t ₂) = 0	Branch to the location in the same page specified by P ₇ to P ₀ if the bit in AC specified by the immediate data t ₁ t ₀ is zero.																	
BMt2 addr	Branch on M bit	1 1 0 1 P ₇ P ₆ P ₅ P ₄	0 1 t ₁ t ₀ P ₃ P ₂ P ₁ P ₀	2	2	PC7 to 0 ← P ₇ P ₆ P ₅ P ₄ P ₃ P ₂ P ₁ P ₀ if [M (HL), t ₂] = 1	Branch to the location in the same page specified by P ₇ to P ₀ if the bit in M (HL) specified by the immediate data t ₁ t ₀ is one.																	
BNMt2 addr	Branch on no M bit	1 0 0 1 P ₇ P ₆ P ₅ P ₄	0 1 t ₁ t ₀ P ₃ P ₂ P ₁ P ₀	2	2	PC7 to 0 ← P ₇ P ₆ P ₅ P ₄ P ₃ P ₂ P ₁ P ₀ if [M (HL), t ₂] = 0	Branch to the location in the same page specified by P ₇ to P ₀ if the bit in M (HL) specified by the immediate data t ₁ t ₀ is zero.																	
BPt2 addr	Branch on Port bit	1 1 0 1 P ₇ P ₆ P ₅ P ₄	1 0 t ₁ t ₀ P ₃ P ₂ P ₁ P ₀	2	2	PC7 to 0 ← P ₇ P ₆ P ₅ P ₄ P ₃ P ₂ P ₁ P ₀ if [P (DP _L), t ₂] = 1	Branch to the location in the same page specified by P ₇ to P ₀ if the bit in port (DP _L) specified by the immediate data t ₁ t ₀ is one.	Internal control registers can also be tested by executing this instruction immediately after a BANK instruction. However, this is limited to registers that can be read out.																
BNPt2 addr	Branch on no Port bit	1 0 0 1 P ₇ P ₆ P ₅ P ₄	1 0 t ₁ t ₀ P ₃ P ₂ P ₁ P ₀	2	2	PC7 to 0 ← P ₇ P ₆ P ₅ P ₄ P ₃ P ₂ P ₁ P ₀ if [P (DP _L), t ₂] = 0	Branch to the location in the same page specified by P ₇ to P ₀ if the bit in port (DP _L) specified by the immediate data t ₁ t ₀ is zero.	Internal control registers can also be tested by executing this instruction immediately after a BANK instruction. However, this is limited to registers that can be read out.																

Continued on next page.

LC665304A, 665306A, 665308A, 665312A, 665316A

Continued from preceding page.

Mnemonic	Instruction code		Number of bytes	Number of cycles	Operation	Description	Affected status bits	Note
	D ₇ D ₆ D ₅ D ₄	D ₃ D ₂ D ₁ D ₀						
[Branch instructions]								
BC addr	Branch on CF	1 1 0 1 P ₇ P ₆ P ₅ P ₄	1 1 0 0 P ₃ P ₂ P ₁ P ₀	2	2	PC7 to 0 ← P ₇ P ₆ P ₅ P ₄ P ₃ P ₂ P ₁ P ₀ if (CF) = 1	Branch to the location in the same page specified by P ₇ to P ₀ if CF is one.	
BNC addr	Branch on no CF	1 0 0 1 P ₇ P ₆ P ₅ P ₄	1 1 0 0 P ₃ P ₂ P ₁ P ₀	2	2	PC7 to 0 ← P ₇ P ₆ P ₅ P ₄ P ₃ P ₂ P ₁ P ₀ if (CF) = 0	Branch to the location in the same page specified by P ₇ to P ₀ if CF is zero.	
BZ addr	Branch on ZF	1 1 0 1 P ₇ P ₆ P ₅ P ₄	1 1 0 1 P ₃ P ₂ P ₁ P ₀	2	2	PC7 to 0 ← P ₇ P ₆ P ₅ P ₄ P ₃ P ₂ P ₁ P ₀ if (ZF) = 1	Branch to the location in the same page specified by P ₇ to P ₀ if ZF is one.	
BNZ addr	Branch on no ZF	1 0 0 1 P ₇ P ₆ P ₅ P ₄	1 1 0 0 P ₃ P ₂ P ₁ P ₀	2	2	PC7 to 0 ← P ₇ P ₆ P ₅ P ₄ P ₃ P ₂ P ₁ P ₀ if (ZF) = 0	Branch to the location in the same page specified by P ₇ to P ₀ if ZF is zero.	
BFn4 addr	Branch on flag bit	1 1 1 1 P ₇ P ₆ P ₅ P ₄	n ₃ n ₂ n ₁ n ₀ P ₃ P ₂ P ₁ P ₀	2	2	PC7 to 0 ← P ₇ P ₆ P ₅ P ₄ P ₃ P ₂ P ₁ P ₀ if (Fn) = 1	Branch to the location in the same page specified by P ₀ to P ₇ if the flag (of the 16 user flags) specified by n ₃ n ₂ n ₁ n ₀ is one.	
BNFn4 addr	Branch on no flag bit	1 0 1 1 P ₇ P ₆ P ₅ P ₄	n ₃ n ₂ n ₁ n ₀ P ₃ P ₂ P ₁ P ₀	2	2	PC7 to 0 ← P ₇ P ₆ P ₅ P ₄ P ₃ P ₂ P ₁ P ₀ if (Fn) = 0	Branch to the location in the same page specified by P ₀ to P ₇ if the flag (of the 16 user flags) specified by n ₃ n ₂ n ₁ n ₀ is zero.	
[I/O instructions]								
IP0	Input port 0 to AC	0 0 1 0	0 0 0 0	1	1	AC ← (P0)	Input the contents of port 0 to AC.	ZF
IP	Input port to AC	0 0 1 0	0 1 1 0	1	1	AC ← [P (DP _L)]	Input the contents of port P (DP _L) to AC.	ZF
IPM	Input port to M	0 0 0 1	1 0 0 1	1	1	M (HL) ← [P (DP _L)]	Input the contents of port P (DP _L) to M (HL).	
IPDR i4	Input port to AC direct	1 1 0 0 0 1 1 0	1 1 1 1 i ₃ i ₂ i ₁ i ₀	2	2	AC ← [P (i4)]	Input the contents of P (i4) to AC.	ZF
IP45	Input port 4, 5 to E, AC respectively	1 1 0 0 1 1 0 1	1 1 1 1 0 1 0 0	2	2	E ← [P (4)] AC ← [P (5)]	Input the contents of ports P (4) and P (5) to E and AC respectively.	
OP	Output AC to port	0 0 1 0	0 1 0 1	1	1	P (DP _L) ← (AC)	Output the contents of AC to port P (DP _L).	
OPM	Output M to port	0 0 0 1	1 0 1 0	1	1	P (DP _L) ← [M (HL)]	Output the contents of M (HL) to port P (DP _L).	
OPDR i4	Output AC to port direct	1 1 0 0 0 1 1 1	1 1 1 1 i ₃ i ₂ i ₁ i ₀	2	2	P (i4) ← (AC)	Output the contents of AC to P (i4).	
OP45	Output E, AC to port 4, 5 respectively	1 1 0 0 1 1 0 1	1 1 1 1 0 1 0 1	2	2	P (4) ← (E) P (5) ← (AC)	Output the contents of E and AC to ports P (4) and P (5) respectively.	
SPB t2	Set port bit	0 0 0 0	1 0 t ₁ t ₀	1	1	[P (DP _L), t2] ← 1	Set to one the bit in port P (DP _L) specified by the immediate data t ₁ t ₀ .	
RPB t2	Reset port bit	0 0 1 0	1 0 t ₁ t ₀	1	1	[P (DP _L), t2] ← 0	Clear to zero the bit in port P (DP _L) specified by the immediate data t ₁ t ₀ .	ZF
ANDPDR i4, p4	And port with immediate data then output	1 1 0 0 i ₃ i ₂ i ₁ i ₀	0 1 0 1 P ₃ P ₂ P ₁ P ₀	2	2	P (P ₃ to P ₀) ← [P (P ₃ to P ₀)] ∨ i ₃ to i ₀	Take the logical AND of P (P ₃ to P ₀) and the immediate data i ₃ i ₂ i ₁ i ₀ and output the result to P (P ₃ to P ₀).	ZF
ORPDR i4, p4	Or port with immediate data then output	1 1 0 0 i ₃ i ₂ i ₁ i ₀	0 1 0 0 P ₃ P ₂ P ₁ P ₀	2	2	P (P ₃ to P ₀) ← [P (P ₃ to P ₀)] ∨ i ₃ to i ₀	Take the logical OR of P (P ₃ to P ₀) and the immediate data i ₃ i ₂ i ₁ i ₀ and output the result to P (P ₃ to P ₀).	ZF

Continued on next page.

LC665304A, 665306A, 665308A, 665312A, 665316A

Continued from preceding page.

Mnemonic		Instruction code		Number of bytes	Number of cycles	Operation	Description	Affected status bits	Note
		D ₇ D ₆ D ₅ D ₄	D ₃ D ₂ D ₁ D ₀						
[Timer control instructions]									
WTTM0	Write timer 0	1 1 0 0	1 0 1 0	1	2	TIMER0 ← [M2 (HL)], (AC)	Write the contents of M2 (HL), AC into the timer 0 reload register.		
WTTM1	Write timer 1	1 1 0 0 1 1 1 1	1 1 1 1 0 1 0 0	2	2	TIMER1 ← (E), (AC)	Write the contents of E, AC into the timer 1 reload register A.		
RTIM0	Read timer 0	1 1 0 0	1 0 1 1	1	2	M2 (HL), AC ← (TIMER0)	Read out the contents of the timer 0 counter into M2 (HL), AC.		
RTIM1	Read timer 1	1 1 0 0 1 1 1 1	1 1 1 1 0 1 0 1	2	2	E, AC ← (TIMER1)	Read out the contents of the timer 1 counter into E, AC.		
START0	Start timer 0	1 1 0 0 1 1 1 0	1 1 1 1 0 1 1 0	2	2	Start timer 0 counter	Start the timer 0 counter.		
START1	Start timer 1	1 1 0 0 1 1 1 0	1 1 1 1 0 1 1 1	2	2	Start timer 1 counter	Start the timer 1 counter.		
STOP0	Stop timer 0	1 1 0 0 1 1 1 1	1 1 1 1 0 1 1 0	2	2	Stop timer 0 counter	Stop the timer 0 counter.		
STOP1	Stop timer 1	1 1 0 0 1 1 1 1	1 1 1 1 0 1 1 1	2	2	Stop timer 1 counter	Stop the timer 1 counter.		
[Interrupt control instructions]									
MSET	Set interrupt master enable flag	1 1 0 0 0 1 0 1	1 1 0 1 0 0 0 0	2	2	MSE ← 1	Set the interrupt master enable flag to one.		
MRESET	Reset interrupt master enable flag	1 1 0 0 1 0 0 1	1 1 0 1 0 0 0 0	2	2	MSE ← 0	Clear the interrupt master enable flag to zero.		
EIH i4	Enable interrupt high	1 1 0 0 0 1 0 1	1 1 0 1 i ₃ i ₂ i ₁ i ₀	2	2	EDIH ← (EDIH) ∨ i4	Set the interrupt enable flag to one.		
EIL i4	Enable interrupt low	1 1 0 0 0 1 0 0	1 1 0 1 i ₃ i ₂ i ₁ i ₀	2	2	EDIL ← (EDIL) ∨ i4	Set the interrupt enable flag to one.		
DIH i4	Disable interrupt high	1 1 0 0 1 0 0 1	1 1 0 1 i ₃ i ₂ i ₁ i ₀	2	2	EDIH ← (EDIH) ∧ $\bar{i}4$	Clear the interrupt enable flag to zero.	ZF	
DIL i4	Disable interrupt low	1 1 0 0 1 0 0 0	1 1 0 1 i ₃ i ₂ i ₁ i ₀	2	2	EDIL ← (EDIL) ∧ $\bar{i}4$	Clear the interrupt enable flag to zero.	ZF	
WTSP	Write SP	1 1 0 0 1 1 0 1	1 1 1 1 1 0 1 0	2	2	SP ← (E), (AC)	Transfer the contents of E, AC to SP.		
RSP	Read SP	1 1 0 0 1 1 0 1	1 1 1 1 1 0 1 1	2	2	E, AC ← (SP)	Transfer the contents of SP to E, AC.		
[Standby control instructions]									
HALT	HALT	1 1 0 0 1 1 0 1	1 1 1 1 1 1 1 0	2	2	HALT	Enter halt mode.		
HOLD	HOLD	1 1 0 0 1 1 0 1	1 1 1 1 1 1 1 1	2	2	HOLD	Enter hold mode.		
[Serial I/O control instructions]									
STARTS	Start serial I/O	1 1 0 0 1 1 1 0	1 1 1 1 1 1 1 0	2	2	START SIO	Start SIO operation.		
WTSIO	Write serial I/O	1 1 0 0 1 1 1 0	1 1 1 1 1 1 1 1	2	2	SIO ← (E), (AC)	Write the contents of E, AC to SIO.		
RSIO	Read serial I/O	1 1 0 0 1 1 1 1	1 1 1 1 1 1 1 1	2	2	E, AC ← (SIO)	Read out the contents of SIO into E, AC.		
[Other instructions]									
NOP	No operation	0 0 0 0	0 0 0 0	1	1	No operation	Consume one machine cycle without performing any operation.		
SB i2	Select bank	1 1 0 0 1 1 0 0	1 1 1 1 0 0 i ₁ i ₀	2	2	PC13, PC12 ← i ₁ i ₀	Specify the memory bank.		

DISCONTINUED PRODUCT

- No products described or contained herein are intended for use in surgical implants, life-support systems, aerospace equipment, nuclear power control systems, vehicles, disaster/crime-prevention equipment and the like, the failure of which may directly or indirectly cause injury, death or property loss.
- Anyone purchasing any products described or contained herein for an above-mentioned use shall:
 - ① Accept full responsibility and indemnify and defend SANYO ELECTRIC CO., LTD., its affiliates, subsidiaries and distributors and all their officers and employees, jointly and severally, against any and all claims and litigation and all damages, cost and expenses associated with such use:
 - ② Not impose any responsibility for any fault or negligence which may be cited in any such claim or litigation on SANYO ELECTRIC CO., LTD., its affiliates, subsidiaries and distributors or any of their officers and employees jointly or severally.
- Information (including circuit diagrams and circuit parameters) herein is for example only; it is not guaranteed for volume production. SANYO believes information herein is accurate and reliable, but no guarantees are made or implied regarding its use or any infringements of intellectual property rights or other rights of third parties.

This catalog provides information as of February, 1997. Specifications and information herein are subject to change without notice.