

The RF Line
UHF Power Amplifiers

... designed specifically for mobile cellular radio applications. The MHW807 Series amplifiers are capable of wide power range control, operate from a 12 volt supply and require only 1.0 mW of RF input power.

- MHW807-1 820 to 850 MHz
 MHW807-2 870 to 905 MHz
- Specified 12.5 Volt Characteristics:
 RF Input Power — 1.0 mW (0 dBm)
 RF Output Power — 6.0 W
 Minimum Gain — 37.8 dB
 Harmonics — -25 dBc Max @ 2.0 f_o
 -45 dBc Max @ 3.0 f_o
- 50 Ohm Input/Output Impedances
- Guaranteed Stability and Ruggedness
- Controllable, Stable Performance Over More Than 35 dB Range in Output Power
- Gold-Metalized and Silicon Nitride-Passivated Transistor Chips

MHW807
Series

6.0 W — 820 to 905 MHz
HIGH GAIN
RF POWER AMPLIFIERS

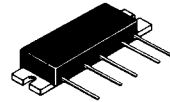

CASE 301L-02, STYLE 2

MAXIMUM RATINGS

Rating	Symbol	Value	Unit
DC Supply Voltages	V _{S1}	9.0	Vdc
	V _{S3}	16	
RF Input Power	P _{in}	3.0	mW
RF Output Power	P _{out}	7.5	W
Operating Case Temperature Range	T _C	-30 to +100	°C
Storage Temperature Range	T _{stg}	-30 to +100	°C
DC Control Voltage	V _{Cont}	9.0	Vdc

ELECTRICAL CHARACTERISTICS (T_C = +25°C, 50 ohm system, unless otherwise noted)

Characteristic	Symbol	Min	Typ	Max	Unit
Frequency Range MHW807-1 MHW807-2	BW	820 870	— —	850 905	MHz
Power Gain (1) (V _{S1} = 8.0 Vdc; V _{S3} = 12.5 Vdc)	G _p	37.8	38.5	—	dB
Efficiency (1) (V _{S1} = 8.0 Vdc; V _{S3} = 12.5 Vdc; P _{out} = 6.0 W)	η	35	38	—	%
Harmonic Output (1) (P _{out} = 6.0 W Reference)	—	—	—	-25 -45	dBc dBc
Input VSWR (1) (P _{out} = 6.0 W, Harmonics Filtered From P _{ref})	VSWR _{in}	—	—	2.5:1	—
Power Slump at Decreased Voltage (1) (T _C = 80°C) (V _{S1} = 8.0 Vdc, V _{S3} = 10 Vdc, V _{Cont} = 0 to 9.0 Vdc)	—	3.0	—	—	W
Load Mismatch Stress (1) (V _{S1} = 8.0 Vdc, V _{S3} = 16 Vdc, P _{out} = 7.0 W)	ψ	No Degradation in Output Power			
Stability (2) (V _{S1} = 8.0 Vdc, V _{S3} = 10 to 16 Vdc; P _{in} = 0.5 to 2.0 mW; P _{out} (Max) = 7.5 W; Load VSWR = 4:1, All Phase Angles)	—	All spurious outputs more than 60 dB below desired signal			
Quiescent Current (I _{S3} With No Drive Applied) (V _{S3} = 12.5 Vdc; V _{S1} = V _{Cont} = 0 Vdc)	I _{S3}	—	—	1.0	mA
Control Voltage Slope (V _{S1} = 8.0 Vdc, V _{S3} = 12.5 Vdc, V _{Cont} = 0 to 9.0 Vdc, P _{in} = 1.0 mW)	—	—	—	5.0	mV/dB

(1) P_{in} = 1.0 mW. Adjust V_{Cont} for specified P_{out}.
 (2) Combination of P_{in}, V_{S1} and V_{Cont} cannot exceed max P_{out} = 7.5 W.

MHW807 Series

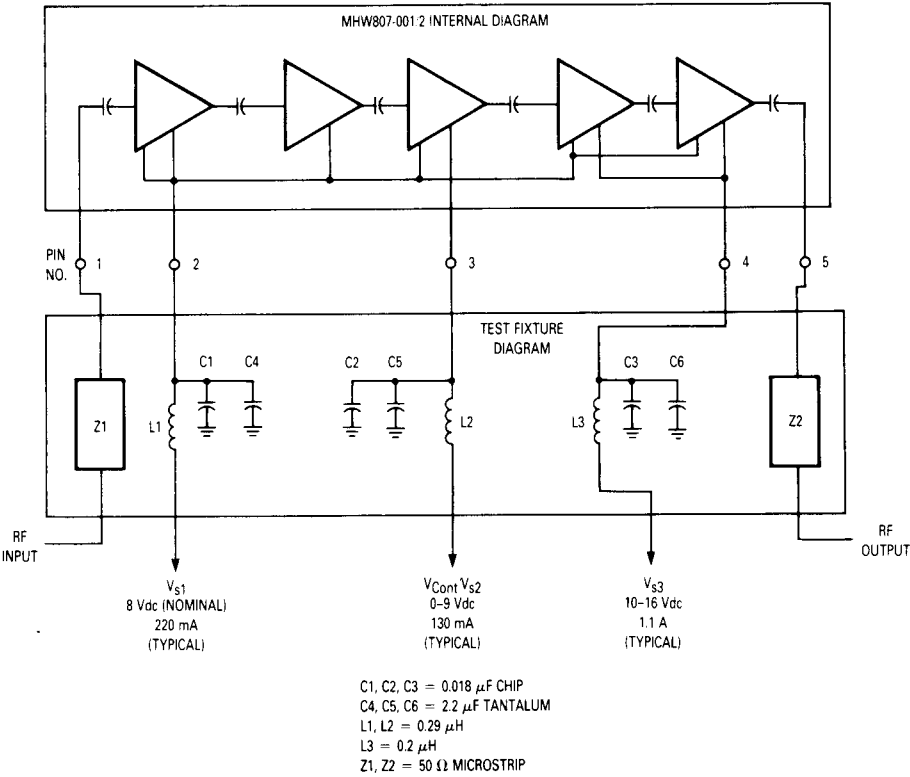

Figure 1. UHF Power Module Test System Diagram

5

TYPICAL CHARACTERISTICS (MHW807-1)

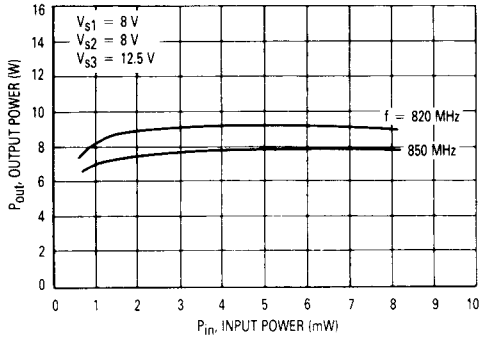

Figure 2. Output Power versus Input Power

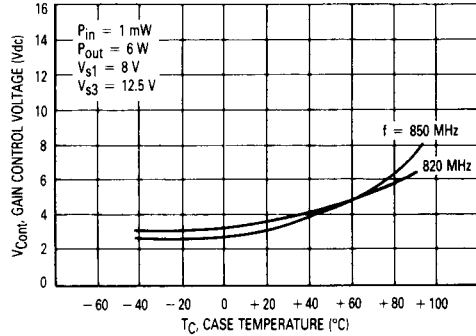

Figure 3. Gain Control Voltage versus Case Temperature

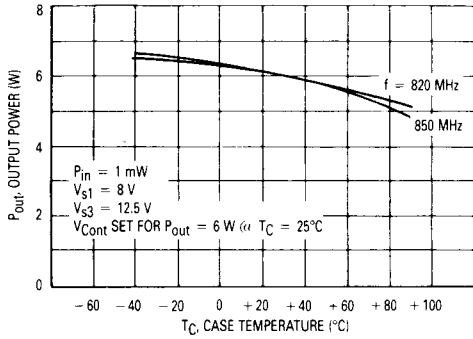

Figure 4. Output Power versus Case Temperature

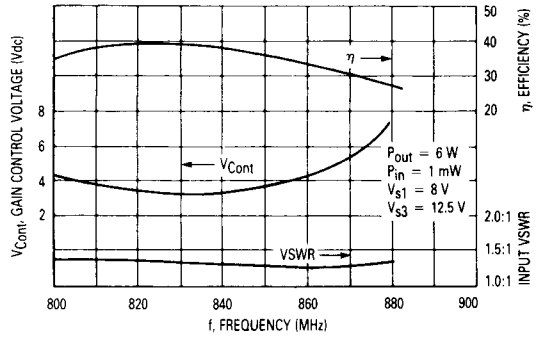

Figure 5. Gain Control Voltage, Input VSWR, Efficiency versus Frequency

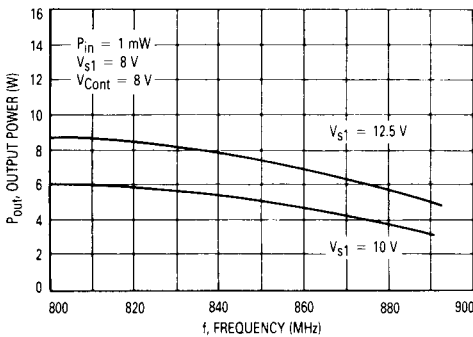

Figure 6. Output Power versus Frequency

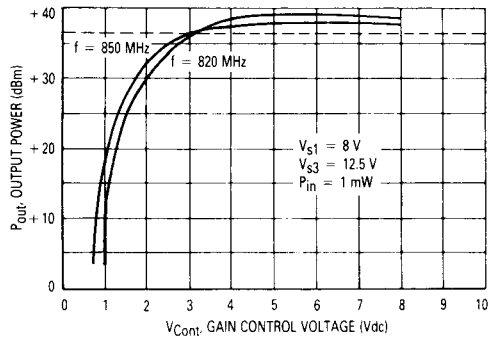

Figure 7. Output Power versus Gain Control Voltage

TYPICAL CHARACTERISTICS (MHW807-2)

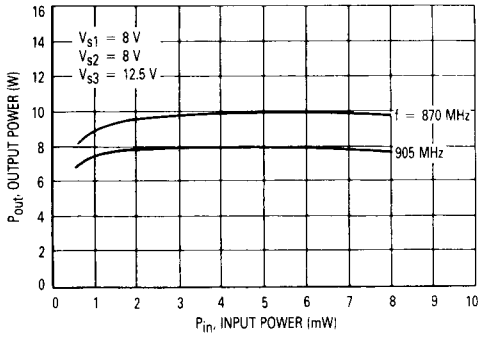

Figure 8. Output Power versus Input Power

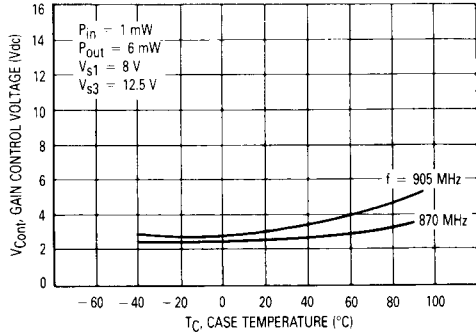

Figure 9. Gain Control Voltage versus Case Temperature

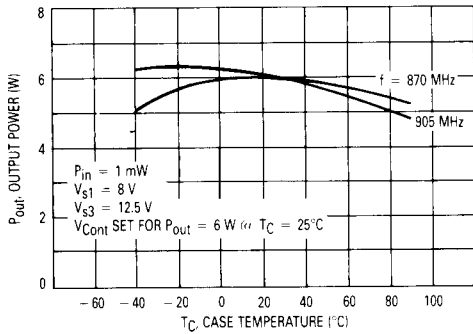

Figure 10. Output Power versus Case Temperature

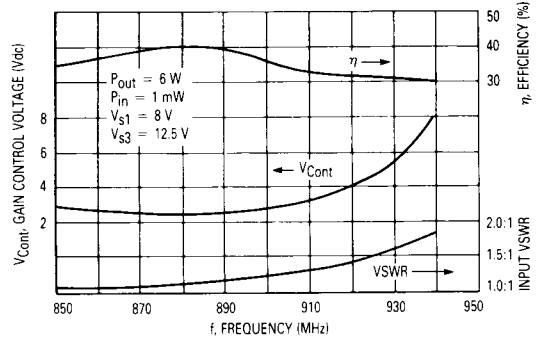

Figure 11. Gain Control Voltage, Input VSWR, Efficiency versus Frequency

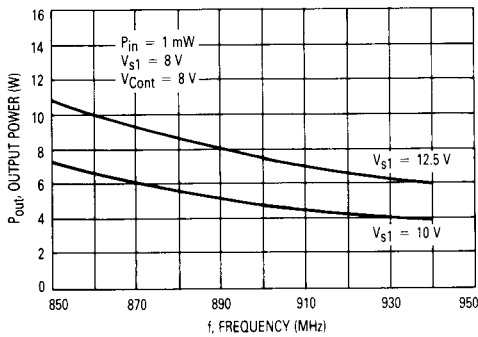

Figure 12. Output Power versus Frequency

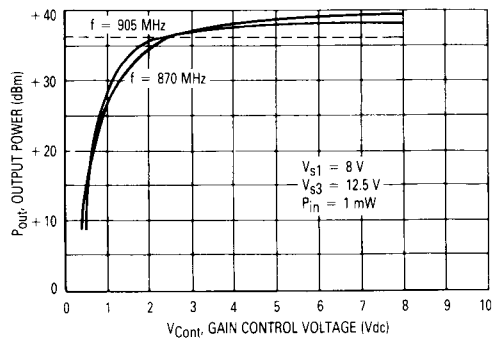

Figure 13. Output Power versus Gain Control Voltage

5

APPLICATIONS INFORMATION

NOMINAL OPERATION

All electrical specifications are based on the following nominal conditions: ($P_{Out} = 6.0 \text{ W}$, $V_{S1} = 8.0 \text{ Vdc}$, $V_{Cont} = 0-9.0 \text{ Vdc}$, $V_{S3} = 12.5 \text{ Vdc}$, $T_C = 25^\circ\text{C}$). This module is designed to have excess gain margin with ruggedness, but operation outside the limits of the published specifications is not recommended unless prior communications regarding the intended use have been made with a factory representative.

GAIN CONTROL

In general, the module output power should be limited to 7.5 watts. The preferred method of power output control is to fix V_{S3} at 12.5 Vdc, V_{S1} at 8.0 Vdc, set RF drive level to 0 dBm and vary the control voltage from 0 to 9.0 Volts. As designed, the module exhibits a gain control range greater than 35 dB using the method described above.

DECOUPLING

Due to the high gain of each of the five stages and the module size limitation, external decoupling networks require careful consideration. Pins 2, 3 and 4 are internally bypassed with a 0.018 μF chip capacitor which is effective for frequencies from 5.0 MHz through 960 MHz. For bypassing frequencies below 5.0 MHz, networks equivalent to that shown in the test fixture schematic are recommended. Inadequate decoupling will result in spurious outputs at specific operating frequencies and phase angles of input and output VSWR.

LOAD MISMATCH STRESS

During final test, each module is load mismatch stress tested in a fixture having the identical decoupling networks described in Figure 1. Electrical conditions are $V_{S3} = 16 \text{ volts}$, $V_{S1} = 8.0 \text{ volts}$, output power equal to 7.0 watts, load VSWR greater than 30:1.

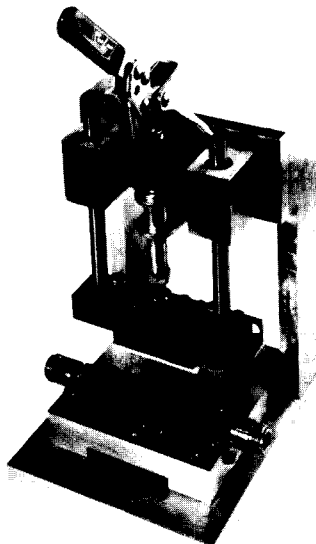

Figure 14. Test Fixture Assembly

MOUNTING CONSIDERATIONS

To insure optimum heat transfer from the flange to heatsink, use standard 4-40 mounting screws and an adequate quantity of silicone thermal compound (e.g., Dow Corning 340). With both mounting screws finger tight, alternately torque down the screws to 4-6 inch pounds. The heatsink mounting surface directly beneath the module flange should be flat to within 0.0015 inch. For more information on module mounting, see EB107/D.

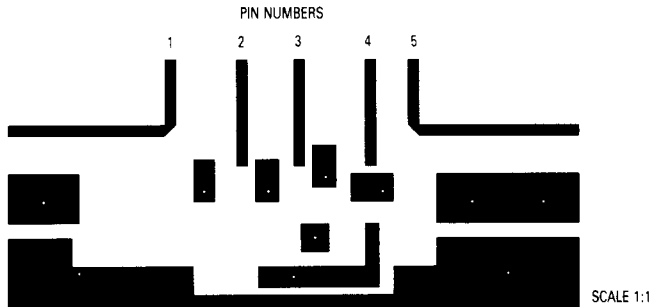

Figure 15. Photomaster For Test Fixture