



**MBRD320
MBRD330
MBRD340**

SCHOTTKY RECTIFIER

3.0 Amp



Major Ratings and Characteristics

Characteristics	Value	Units
$I_{F(AV)}$ Rectangular waveform	3.0	A
V_{RRM}	20 - 30 - 40	V
I_{FSM} @tp = 5 μ s sine	490	A
V_F @3Apk, $T_J = 125^\circ\text{C}$	0.49	V
T_J	-40 to 150	$^\circ\text{C}$

Description/Features

The MBRD320, MBRD330, MBRD340 surface mount Schottky rectifier has been designed for applications requiring low forward drop and small foot prints on PC board. Typical applications are in disk drives, switching power supplies, converters, free-wheeling diodes, battery charging, and reverse battery protection.

- Popular D-PAK outline
- Small foot print, surface mountable
- Low forward voltage drop
- High frequency operation
- Guard ring for enhanced ruggedness and long term reliability

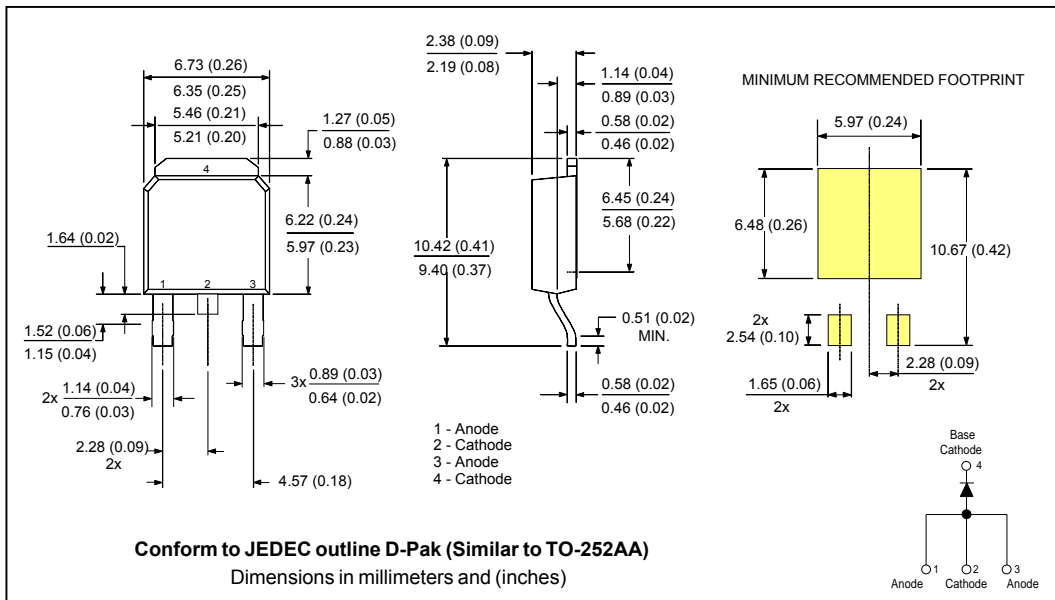

Voltage Ratings

Part number	MBRD320	MBRD330	MBRD340
V _R Max. DC Reverse Voltage (V)	20	30	40
V _{RWM} Max. Working Peak Reverse Voltage (V)			

Absolute Maximum Ratings

Parameters	Value	Units	Conditions
I _{F(AV)} Max. Average Forward Current	3.0	A	50% duty cycle @ T _L = 133°C, rectangular wave form
I _{FSM} Max. Peak One Cycle Non-Repetitive Surge Current	490	A	Following any rated load condition and with rated V _{RRM} applied
	75		
E _{AS} Non Repetitive Avalanche Energy	8	mJ	T _J = 25°C, I _{AS} = 0.6A, L = 5mH
I _{AR} Repetitive Avalanche Current	1.0	A	

Electrical Specifications

Parameters	Typ.	Max.	Units	Conditions
V _{FM} Max. Forward Voltage Drop (1) See Fig. 1	0.48	0.6	V	@ 3A
	0.58	0.7	V	@ 6A
	0.41	0.49	V	@ 3A
	0.55	0.625	V	@ 6A
I _{RM} Max. Reverse Leakage Current (1) See Fig. 2	0.02	0.2	mA	T _J = 25°C
	10.7	20	mA	T _J = 125°C
C _T Typical Junction Capacitance	189	-	pF	V _R = 5V _{DC} (test signal range 100kHz to 1Mhz), @ 25°C
L _S Typical Series Inductance	5.0	-	nH	Measured lead to lead 5mm from package body
dv/dt Max. Voltage Rate of Change	-	10000	V/μs	(Rated V _R)

(1) Pulse Width < 300μs, Duty Cycle < 2%

Thermal-Mechanical Specifications

Parameters	Value	Units	Conditions
T _J Max. Junction Temperature Range (*)	-40 to 150	°C	
T _{stg} Max. Storage Temperature Range	-40 to 175	°C	
R _{thJC} Max. Thermal Resistance Junction to Case	6.0	°C/W	DC operation * See Fig. 4
R _{thJA} Max. Thermal Resistance Junction to Ambient	80	°C/W	
wt Approximate Weight	0.3(0.01)	g(oz.)	
Case Style	D - PAK		Similar to TO-252AA

(*) $\frac{dP_{tot}}{dT_J} < \frac{1}{R_{th(j-a)}}$ thermal runaway condition for a diode on its own heatsink

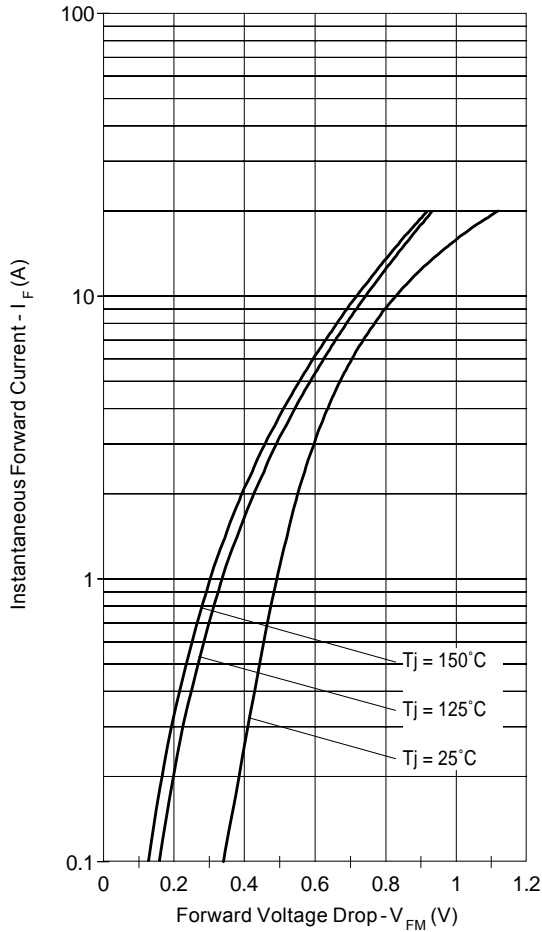

Fig. 1 - Maximum Forward Voltage Drop Characteristics

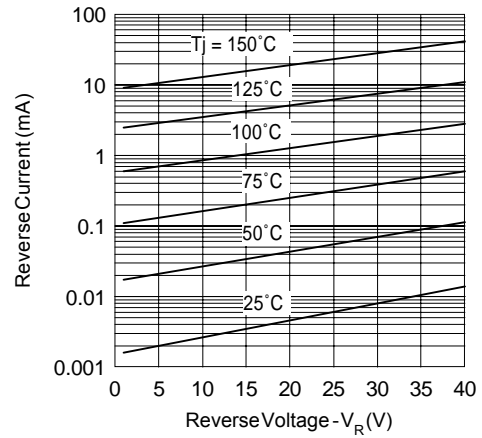

Fig. 2 - Typical Values of Reverse Current Vs. Reverse Voltage

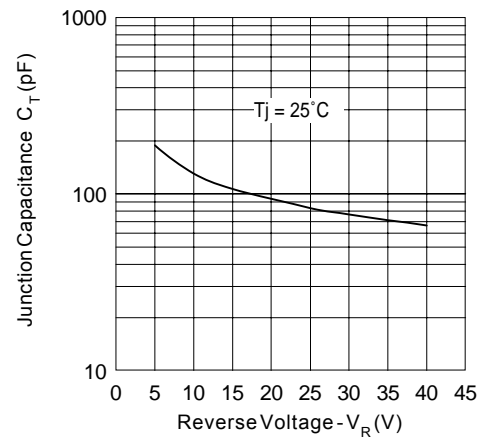

Fig. 3 - Typical Junction Capacitance Vs. Reverse Voltage

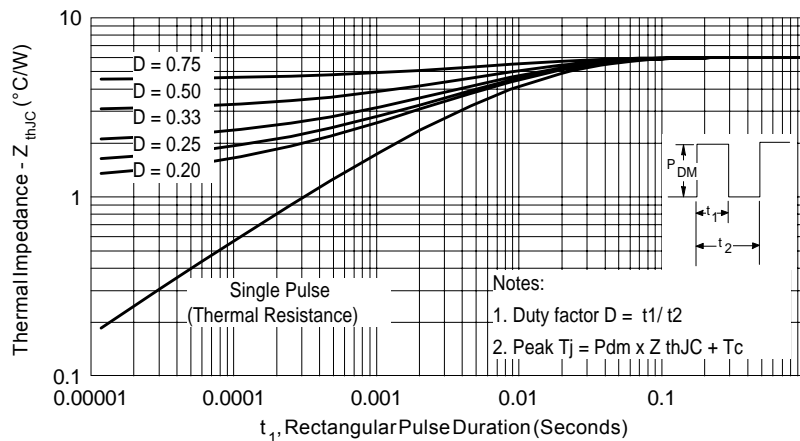

Fig. 4 - Maximum Thermal Impedance Z_{thJC} Characteristics

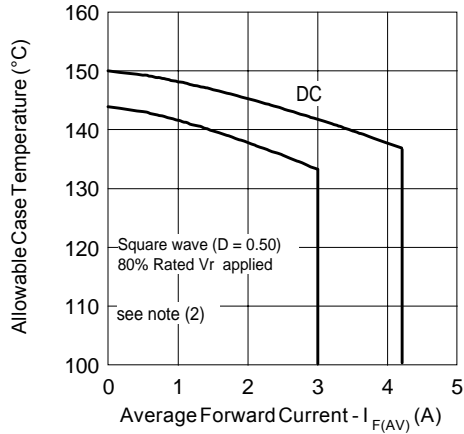

Fig. 5 - Maximum Allowable Case Temperature Vs. Average Forward Current

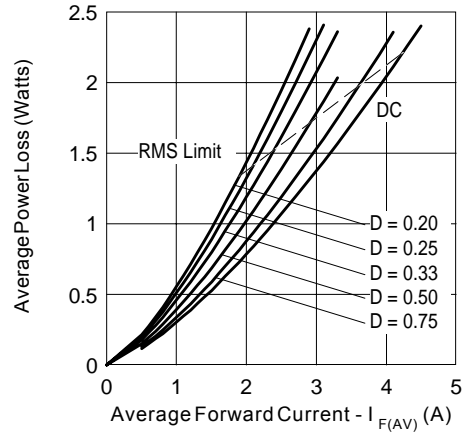

Fig. 6 - Forward Power Loss Characteristics

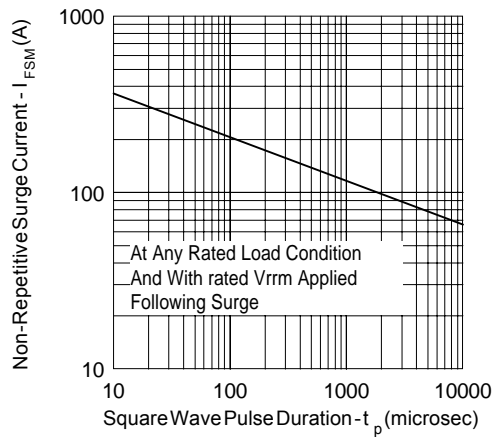

Fig. 7 - Maximum Non-Repetitive Surge Current

(2) Formula used: $T_c = T_j - (Pd + Pd_{REV}) \times R_{thJC}$;

Pd = Forward Power Loss = $I_{F(AV)} \times V_{FM} @ (I_{F(AV)} / D)$ (see Fig. 6);

Pd_{REV} = Inverse Power Loss = $V_{R1} \times I_R (1 - D)$; $I_R @ V_{R1} = 80\%$ rated V_R

Marking Information

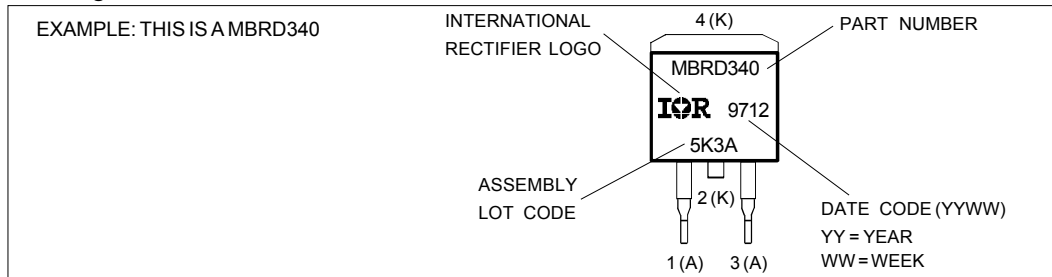

Tape & Reel Information

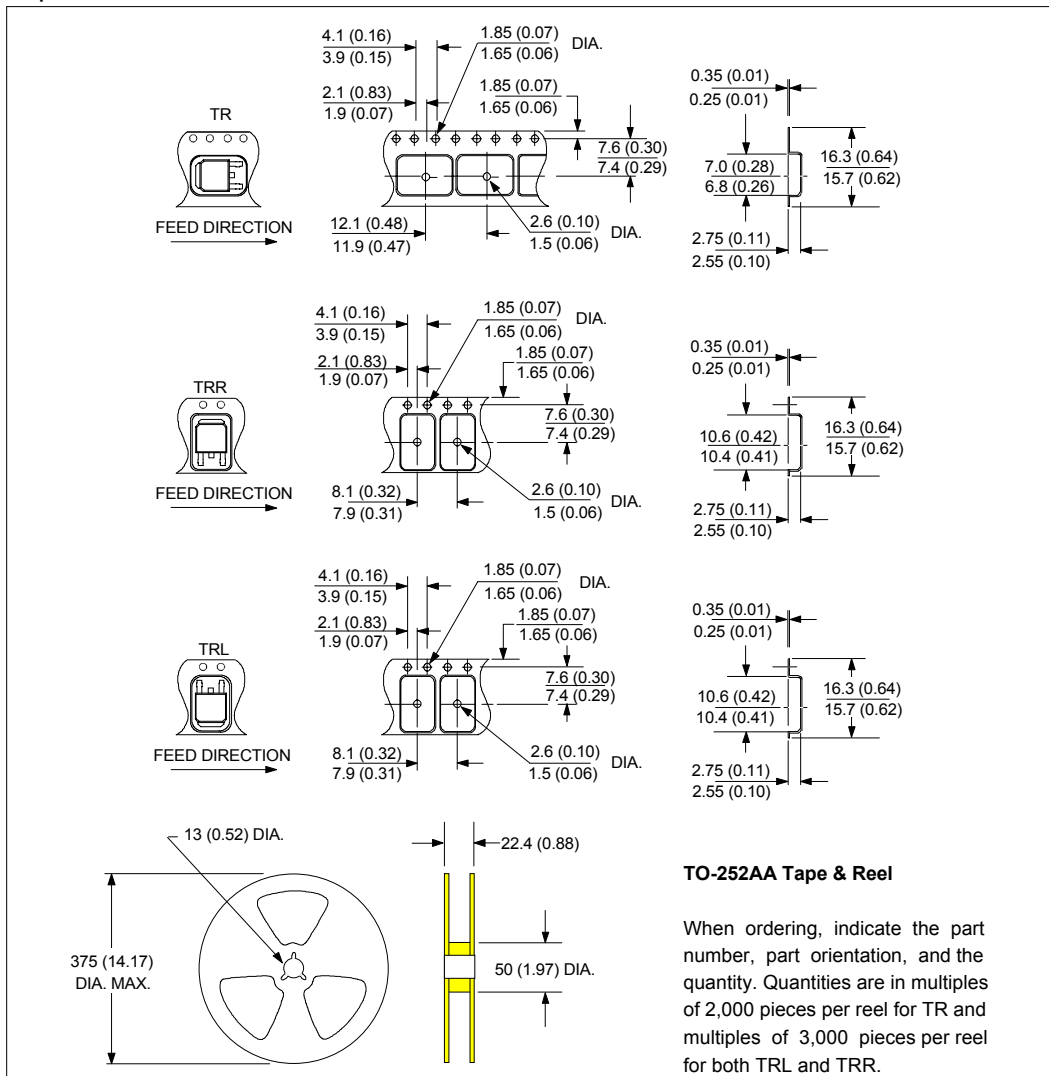

MBRD320, MBRD330, MBRD340

Bulletin PD-20756 rev. B 02/02

International
IOR Rectifier

Data and specifications subject to change without notice.
This product has been designed and qualified for Industrial Level.
Qualification Standards can be found on IR's Web site.

International
IOR Rectifier

IR WORLD HEADQUARTERS: 233 Kansas St., El Segundo, California 90245, USA Tel: (310) 252-7105
TAC Fax: (310) 252-7309
Visit us at www.irf.com for sales contact information. 02/02