

FS5VSH-2

HIGH-SPEED SWITCHING USE

FS5VSH-2



- 2.5V DRIVE
- V_{DSS} 100V
- r_{DS} (ON) (MAX) 0.44Ω
- I_D 5A
- Integrated Fast Recovery Diode (TYP.) 80ns

OUTLINE DRAWING Dimensions in mm

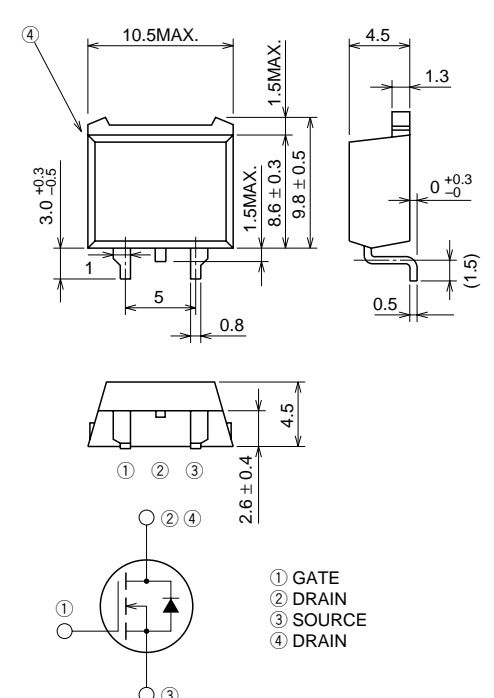

① GATE
② DRAIN
③ SOURCE
④ DRAIN

TO-220S

APPLICATION

Motor control, Lamp control, Solenoid control
DC-DC converter, etc.

MAXIMUM RATINGS (T_c = 25°C)

Symbol	Parameter	Conditions	Ratings	Unit
V _{DSS}	Drain-source voltage	V _{GS} = 0V	100	V
V _{GSS}	Gate-source voltage	V _{DS} = 0V	±10	V
I _D	Drain current		5	A
I _{DM}	Drain current (Pulsed)		20	A
I _{DA}	Avalanche drain current (Pulsed)	L = 100μH	5	A
I _S	Source current		5	A
I _{SM}	Source current (Pulsed)		20	A
P _D	Maximum power dissipation		20	W
T _{ch}	Channel temperature		-55 ~ +150	°C
T _{stg}	Storage temperature		-55 ~ +150	°C
—	Weight	Typical value	1.2	g

ELECTRICAL CHARACTERISTICS (T_{ch} = 25°C)

Symbol	Parameter	Test conditions	Limits			Unit
			Min.	Typ.	Max.	
V _{(BR)DSS}	Drain-source breakdown voltage	I _D = 1mA, V _{GS} = 0V	100	—	—	V
I _{GSS}	Gate-source leakage current	V _{GS} = ±10V, V _{DS} = 0V	—	—	±0.1	μA
I _{DSS}	Drain-source leakage current	V _{DS} = 100V, V _{GS} = 0V	—	—	0.1	mA
V _{GS(th)}	Gate-source threshold voltage	I _D = 1mA, V _{DS} = 10V	0.6	0.9	1.2	V
r _{DS(on)}	Drain-source on-state resistance	I _D = 2A, V _{GS} = 4V	—	0.32	0.44	Ω
r _{DS(on)}	Drain-source on-state resistance	I _D = 2A, V _{GS} = 2.5V	—	0.34	0.47	Ω
V _{DS(on)}	Drain-source on-state voltage	I _D = 2A, V _{GS} = 4V	—	0.64	0.88	V
y _{fs}	Forward transfer admittance	I _D = 2A, V _{DS} = 5V	—	10	—	S
C _{iss}	Input capacitance	V _{DS} = 10V, V _{GS} = 0V, f = 1MHz	—	540	—	pF
C _{oss}	Output capacitance		—	75	—	pF
C _{rss}	Reverse transfer capacitance		—	20	—	pF
t _{d(on)}	Turn-on delay time	V _{DD} = 50V, I _D = 2A, V _{GS} = 4V, R _{GEN} = R _{GS} = 50Ω	—	12	—	ns
t _r	Rise time		—	18	—	ns
t _{d(off)}	Turn-off delay time		—	45	—	ns
t _f	Fall time		—	26	—	ns
V _{SD}	Source-drain voltage	I _S = 2A, V _{GS} = 0V	—	1.0	1.5	V
R _{th(ch-c)}	Thermal resistance	Channel to case	—	—	6.25	°C/W
t _{rr}	Reverse recovery time	I _S = 5A, di _s /dt = -100A/μs	—	80	—	ns

PERFORMANCE CURVES

POWER DISSIPATION DERATING CURVE

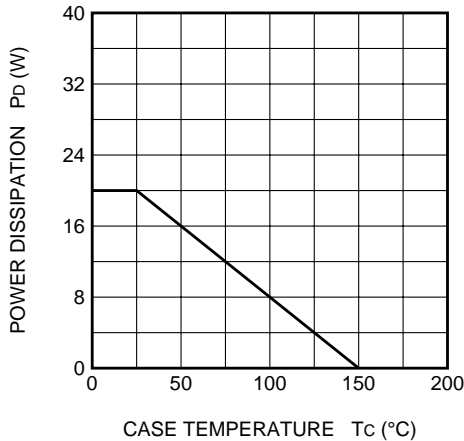

MAXIMUM SAFE OPERATING AREA

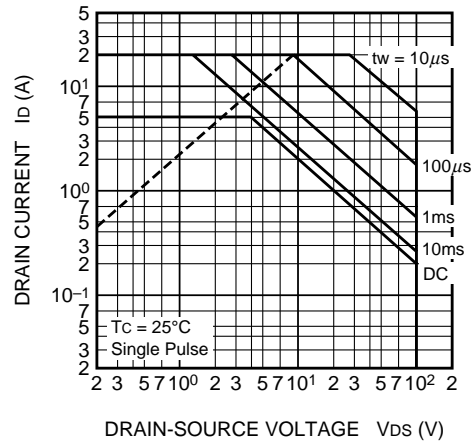

OUTPUT CHARACTERISTICS (TYPICAL)

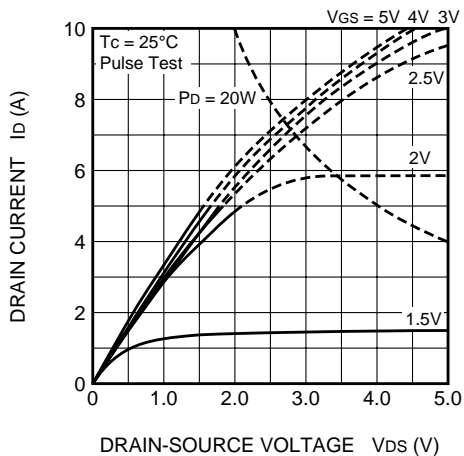

OUTPUT CHARACTERISTICS (TYPICAL)

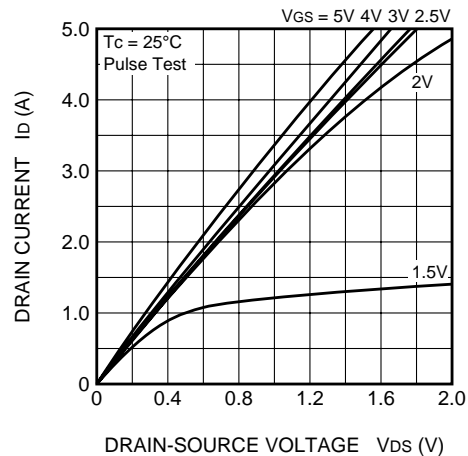

ON-STATE VOLTAGE VS. GATE-SOURCE VOLTAGE (TYPICAL)

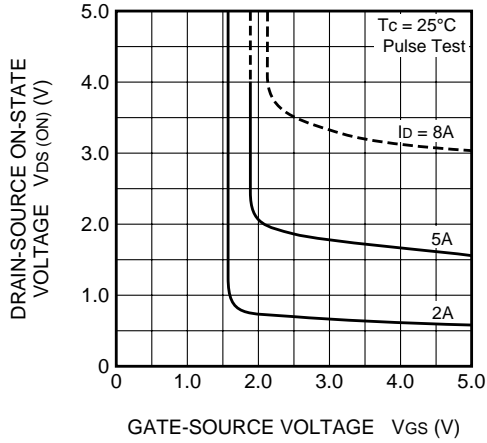

ON-STATE RESISTANCE VS. DRAIN CURRENT (TYPICAL)

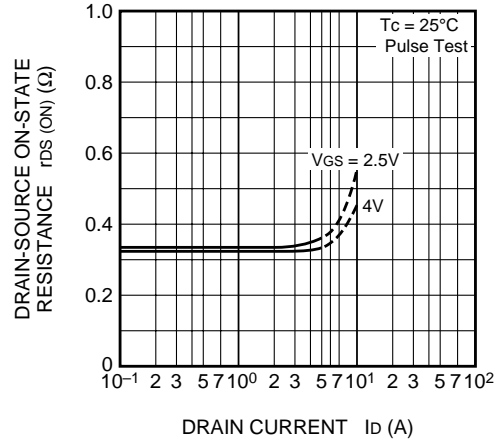

TRANSFER CHARACTERISTICS (TYPICAL)

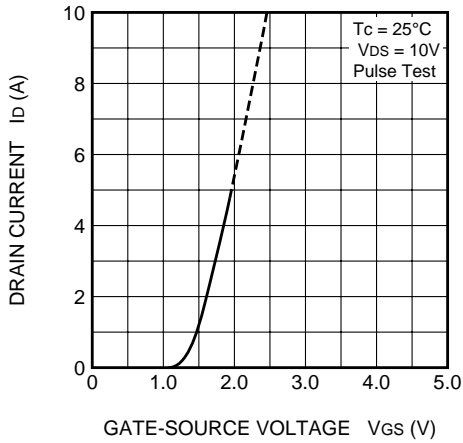

FORWARD TRANSFER ADMITTANCE VS. DRAIN CURRENT (TYPICAL)

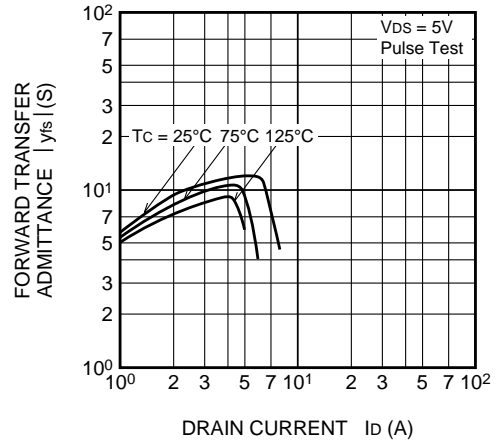

CAPACITANCE VS. DRAIN-SOURCE VOLTAGE (TYPICAL)

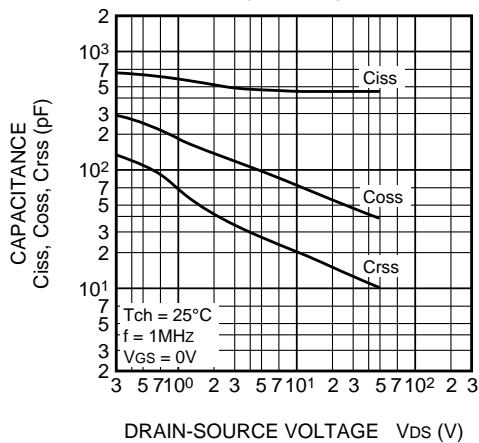

SWITCHING CHARACTERISTICS (TYPICAL)

